



AGRAR

GESAMTSORTIMENT

11/23



AGRAR

Bohnenkamp
Moving Professionals

www.bohnenkamp.com

WIR SIND IHR PARTNER RUND UM REIFEN UND RÄDER IM PROFESSIONELLEN EINSATZ!

Fordern Sie gerne weitere Produktübersichten an.
Tel. +49 541 12163-0 · info@bohlenkamp.de oder über den QR Code.



AGRAR

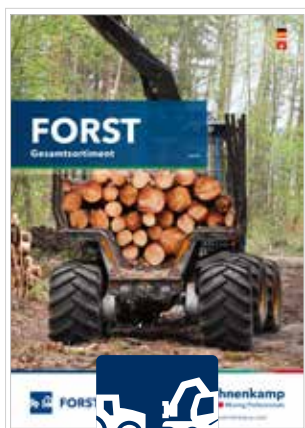

FORST



ERDBEWEGUNG /
HAFEN / INDUSTRIE



LANDSCHAFTSPFLEGE,
HOF UND FREIZEIT



TRUCK &
TRANSPORT



FAHRZEUGBAU-
SYSTEME



MONTAGEZUBEHÖR

Viele weitere Produktübersichten, Broschüren und Flyer finden Sie in der
MEDIATHEK auf unserer Webseite unter www.bohlenkamp.de



REIFEN, RÄDER, FELGEN, SCHLÄUCHE, ZUBEHÖR



ALLES AUS EINER HAND

Unser Produktsortiment umfasst Reifen, Räder, Felgen, Schläuche und Fahrzeugbauteile für nahezu jedes Fahrzeug und jeden Einsatz.

STARKE MARKEN

für die Landwirtschaft

ALLIANCE
ENGINEERED TO KEEP YOU AHEAD

BKT
GROWING TOGETHER

BK TUBE
MASTERLINE

BK TUBE
FORESTLINE

BOYA WHEEL

BRIDGESTONE

CARLISLE
TRANSPORTATION PRODUCTS

Continental

COVEX

CST

Dell Tire

DONG AH

Firestone

GALAXY

KENDA

Kleber

MAXAM

MAXXIS
REIFEN



REIFEN, RÄDER, FELGEN, SCHLÄUCHE, ZUBEHÖR

UNSER SERVICEANGEBOT

- Höchste Verfügbarkeit
- After-Sales-Service vor Ort
- Versandkostenfrei bereits bei kleinen Stückzahlen
- Online-Shop & App für 24-Stunden-Bestellungen
- Day-to-Day Lieferservice



Mitas

NEXEN TIRE

**NOKIAN
TYRES**

**SAILUN
TYRE**

**SECURITY
TYRES**

STARO GS

**TRELLEBORG
WHEEL SYSTEMS**

REDESTEN

WINDPOWER
Get Your Job Done

**Hartwig
Räderbau GmbH**

LEVYPYÖRÄ
MEMBER OF NOKIAN TYRES

moveero

StocksAG

TRINKER

Bohnenkamp

■ ■ ● Moving Professionals



Ihre Ansprechpartner in Deutschland

Verkauf für den Landmaschinenhandel

Tel.: 0 541 121 63 - 100 (Sammelrufnummer)



Heiko Holthaus

Leitung Geschäftsbereich Agrar
Durchwahl: -749
heiko.holthaus@bohlenkamp.de



Patrick Ostwald

Stellvertretender Bereichsleiter
Durchwahl: -170
patrick.ostwald@bohlenkamp.de



Felix Borken

Durchwahl: -231
felix.borken@bohlenkamp.de



Mike Hartmann

Durchwahl: -160
mike.hartmann@bohlenkamp.de



Wolfgang Hindermann

Durchwahl: -168
wolfgang.hindermann@bohlenkamp.de



Markus Hinz

Durchwahl: -171
markus.hinz@bohlenkamp.de



Uwe Huesmann

Durchwahl: -120
uwe.huesmann@bohlenkamp.de



Tim Jendrik Kleine

Durchwahl: -278
tim.kleine@bohlenkamp.de



Dennis Scholko

Durchwahl: -169
dennis.scholko@bohlenkamp.de



Iris Soukup

Durchwahl: -158
iris.soukup@bohlenkamp.de



Oliver Wellmann

Durchwahl: -134
oliver.wellmann@bohlenkamp.de



Verkauf für den Reifenhandel

Tel.: 0 541 121 63-200 (Sammelrufnummer)



Karsten Krückeberg
Leitung Geschäftsbereich EM/Truck
Durchwahl: -237
karsten.krueckeberg@bohlenkamp.de



Christian Pieper
Stellvertretender Bereichsleiter
Durchwahl: -279
christian.pieper@bohlenkamp.de



Anja Bautz
Durchwahl: -259
anja.bautz@bohlenkamp.de



Nele Grützner
Durchwahl: -232
nele.gruetzner@bohlenkamp.de



Johannes Krämer
Durchwahl: -258
johannes.kraemer@bohlenkamp.de



Nils Lamping
Durchwahl: -238
nils.lamping@bohlenkamp.de



Halil Ibrahim Özen
Durchwahl: -227
halilibrahim.oezen@bohlenkamp.de



Claudia Santos
Durchwahl: -245
claudia.santos@bohlenkamp.de



Marcel Wesenberg
Durchwahl: -272
marcel.wesenberg@bohlenkamp.de



Matthias Wojcik
Durchwahl: -280
matthias.wojcik@bohlenkamp.de



Martina Wolff
Durchwahl: -291
martina.wolff@bohlenkamp.de



Marius Zumstrull
Durchwahl: -270
marius.zumstrull@bohlenkamp.de





Ihre Ansprechpartner in Deutschland

Verkauf für die Erstausrüstung Agrar / Forst / Kommunal

Tel.: 0541 121 63-300 (Sammelrufnummer)



Gert Timmer
Geschäftsbereichsleiter
OE Agrar & Forst / Kommunal
Durchwahl: -310
gert.timmer@bohenkamp.de



Sebastian Kruse-Grafe
Stellvertretender Bereichsleiter
Durchwahl: -357
sebastian.kruse-grafe@bohenkamp.de



Jan Blumberg
Durchwahl: -230
jan.blumberg@bohenkamp.de



Simon Büscher
Durchwahl: -356
simon.buescher@bohenkamp.de



Vitalij Cherevko
Durchwahl: -213
vitalij.cherevko@bohenkamp.de



Georg Diekgers
Durchwahl: -329
georg.diekgers@bohenkamp.de



Jan Jasper
Durchwahl: -317
jan.jasper@bohenkamp.de



Sofia Serra Bülte
Durchwahl: -312
sofia.serrabuelte@bohenkamp.de



Anton Stempel
Durchwahl: -318
anton.stempel@bohenkamp.de

Verkauf für die Erstausrüstung EM / Industrie und Truck

Tel.: 0541 121 63-301 (Sammelrufnummer)



Çağlar Tosun
Geschäftsbereichsleiter
OE EM & Industrie / Truck
Mobil: +49 170 7646107
caglar.tosun@bohenkamp.de



Sven van Buer
Key Account Manager OE
EM & Industrie
Mobil: +49 151 11165660
sven.vanbuer@bohenkamp.de



Andrea Hüpel
Durchwahl: -390
andrea.huepel@bohenkamp.de



Thorsten Kahmann
Durchwahl: -374
thorsten.kahmann@bohenkamp.de



Felix Voßgröne
Durchwahl: -207
felix.vossgroene@bohenkamp.de

EINFACH UND MOBIL

Bohnenkamp Digital

BOHNENKAMP DIGITAL



ONLINE-SHOP

- Direkter Zugriff auf unser gesamtes Sortiment
- Alle Lagerbestände und Preise auf einen Blick
- Auf Wunsch mit eigenem Layout
- Viele hilfreiche Servicetools



ONLINE-SHOP-APP

- Der gesamte Onlineshop für Tablet und Handy
- Nutzung auch ohne Internetverbindung möglich
- Anmeldung per Fingerprint
- Für Android und Apple verfügbar



TECHNISCHER-RATGEBER-APP

- Technische Gesamtübersicht aller gängigen Reifengrößen
- Filtern nach allen wichtigen Kriterien
- Alle technischen Details für den professionellen Einsatz



Ansprechpartner Vertriebsbüros und Niederlassungen Deutschland

Fachabteilung Kleinreifen Vertriebsbüro Lüneburg

Pulverweg 1a · 21337 Lüneburg Tel.: +49 (0) 4131 29895- Durchwahl



Svend Burkhardt
Niederlassungsleiter

Durchwahl: -63
svend.burkhardt@bohenkamp.de



Alexandra Behr

Durchwahl: -67
alexandra.behr@bohenkamp.de



Michael Kleckner

Durchwahl: -62
michael.kleckner@bohenkamp.de



Olav Kleinow

Durchwahl: -57
olav.kleinow@bohenkamp.de



Timo Potratz

Durchwahl: -58
timo.potratz@bohenkamp.de



Anja Stuhlmacher

Durchwahl: -48
anja.stuhlmacher@bohenkamp.de



Yildiray Yalcin

Durchwahl: -51
yildiray.yalcin@bohenkamp.de

Vertriebsbüro Leipzig

Straßburger Straße 1 · 06184 Kabelsketal OT Großkugel Tel.: +49 (0) 341 39299- Durchwahl



Henry Hoffmann

Durchwahl: -541
henry.hoffmann@bohenkamp.de



Sebastian Liebich

Durchwahl: -544
sebastian.liebich@bohenkamp.de



Alle Bohnenkamp-Standorte
sind ISO zertifiziert

Hinweis: Diese Produktübersicht wurde mit großer Sorgfalt erstellt. Trotzdem können wir für eventuelle Fehler in der Produktbeschreibung oder in den technischen Daten keine Gewähr übernehmen. Änderungen im Design bzw. technische Weiterentwicklungen vorbehalten. Im Übrigen gelten unsere Verkaufs-, Lieferungs- und Zahlungsbedingungen. Zu finden unter www.bohenkamp.com Irrtümer vorbehalten

Niederlassung Landshut

Landshuter Straße 57 · 84051 Altheim Tel.: +49 (0) 8703 938 - Durchwahl



Christopher Wagner
Niederlassungsleiter

Durchwahl: -11
christopher.wagner@bohnenkamp.de



Maximilian Bohrer

Durchwahl: -28
maximilian.bohrer@bohnenkamp.de

Niederlassung Kletzin

Dortstraße 93 · 17111 Kletzin Tel.: +49 (0) 39998 316 - Durchwahl



Eberhard Schumacher
Niederlassungsleiter

Durchwahl: -11
eberhard.schumacher@bohnenkamp.de



Cathleen Bidla

Durchwahl: -12
cathleen.bidla@bohnenkamp.de



Daniel Breitsprecher

Durchwahl: -16
daniel.breitsprecher@bohnenkamp.de



Sylvana Felgenhauer

Durchwahl: -13
sylvana.felgenhauer@bohnenkamp.de



Felix Knaak

Durchwahl: -15
felix.knaak@bohnenkamp.de



Olaf Krause

Durchwahl: -10
olaf.krause@bohnenkamp.de





Ihre Ansprechpartner vor Ort in Deutschland

Gebietsleiter



1 **Markus Schmidt**
Mobil: +49 171 3389881
markus.schmidt@bohnenkamp.de



2 **Andreas Abeln**
Mobil: +49 151 64959140
andreas.abeln@bohnenkamp.de



3 **Julius Obermeyer**
Mobil: +49 151 26373004
julius.obermeyer@bohnenkamp.de



4 **Eberhard Schumacher**
Mobil: +49 171 3042486
eberhard.schumacher@bohnenkamp.de



5 **Robert Kolassa**
Mobil: +49 151 21665505
robert.kolassa@bohnenkamp.de



6 **Dirk Lewandowski**
Mobil: +49 171 3389885
dirk.lewandowski@bohnenkamp.de



7 **Thomas Süptitz**
Mobil: +49 151 56036767
thomas.sueptitz@bohnenkamp.de



8 **Timo Schneider**
Mobil: +49 160 90602981
timo.schneider@bohnenkamp.de



9 **Frank Schiff**
Mobil: +49 151 46756722
frank.schiff@bohnenkamp.de



10 **Peter Funk**
Mobil: +49 49 171 9751633
peter.funk@bohnenkamp.de



11 **Martin Scharf**
Mobil: +49 171 5685374
martin.scharf@bohnenkamp.de



12 **Bernd Wilke**
Mobil: +49 171 3389888
bernd.wilke@bohnenkamp.de



13 **Stephan Gajda**
Mobil: +49 151 57315357
stephan.gajda@bohnenkamp.de



14 **Andreas Rausch**
Mobil: +49 151 23075677
andreas.rausch@bohnenkamp.de



Key Account Management



Michael Fischer
Key Account Manager EM & Industrie Nord
Mobil: +49 160 95134690
michael.fischer@bohnenkamp.de



Joachim Schippan
Key Account Manager EM & Industrie Süd
Mobil: +49 170 1447479
joachim.schippan@bohnenkamp.de



Sven van Buer
Key Account Manager OE EM & Industrie
Mobil: +49 151 11165660
sven.vanbuer@bohnenkamp.de



Mark Sobiech
Key Account Manager Truck & Trailer
Mobil: +49 171 8194205
mark.sobiech@bohnenkamp.de



Svend Burkhardt
Key Account Manager Kommunal & Powersport
Tel: +49 4131 29895 63
svend.burkhardt@bohnenkamp.de

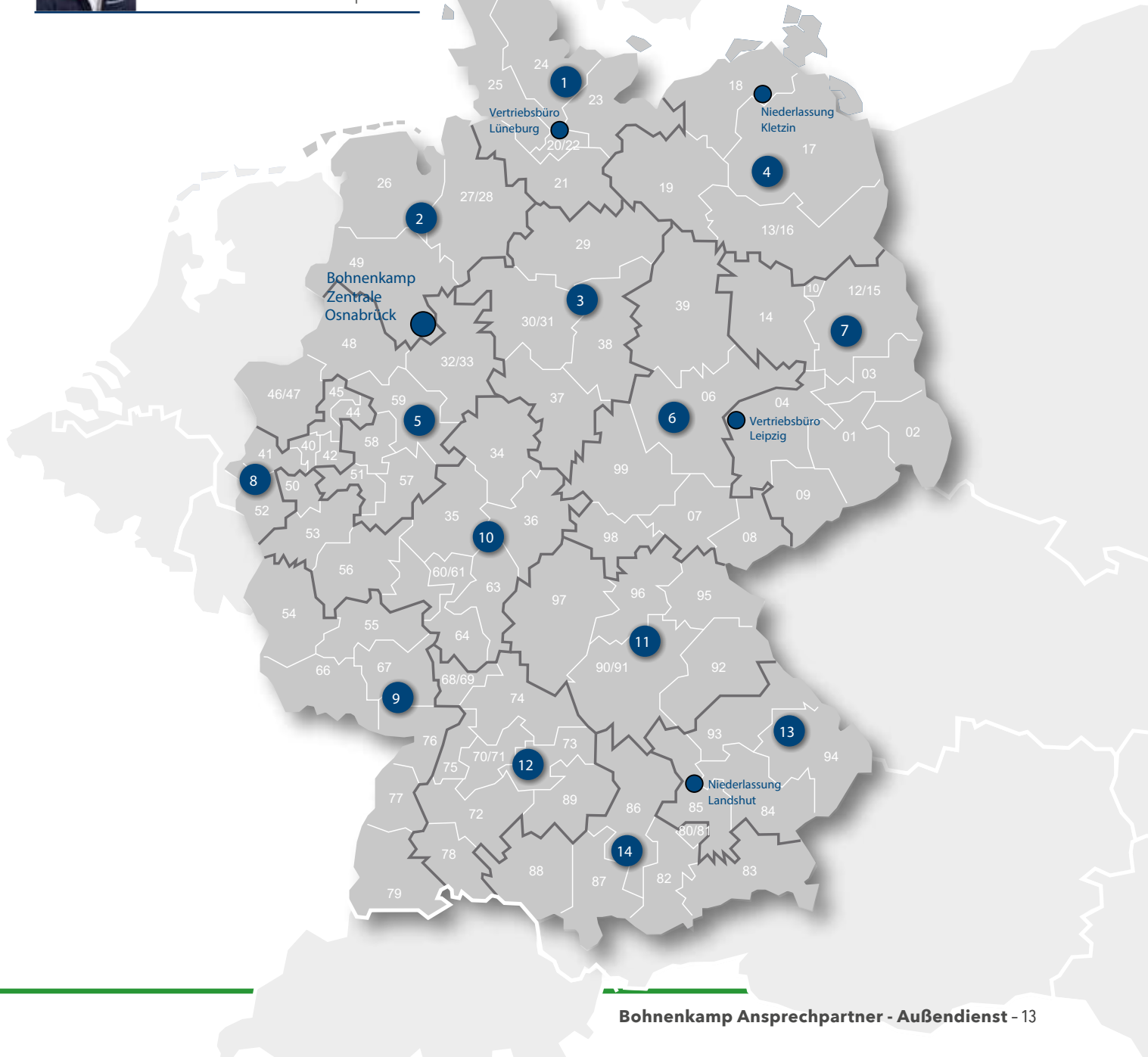

VERSAND UND FRACHTKOSTEN

BOHNENKAMP LOGISITK



24 STUNDEN

SPEDITION

Bestellannahme:

Mo. - Do. bis 15.00 Uhr / Fr. bis 14.00 Uhr:

Lieferung am nächsten Werktag*

Frachtkosten: unter 200,- EUR Auftragswert 8,- EUR



24 STUNDEN
PAKETDIENST

PAKETDIENST

Bestellannahme:

Mo. - Do. bis 16.00 Uhr / Fr. bis 15.00 Uhr:

Lieferung am nächsten Werktag*

Frachtkosten: unter 200,- EUR Auftragswert 8,- EUR



EXPRESS
8.00 Uhr

NACHTVERTEILSERVICE

Bestellannahme:

Mo. - Do. bis 16.00 Uhr / Fr. bis 15.00 Uhr:

Lieferung nächster Werktag bis 8:00 Uhr

Frachtkosten: unfrei - Preisbestätigung der Versandkosten

* Gemäß Regellaufzeit der beauftragten Dienstleister
Irrtümer vorbehalten



Inhaltsverzeichnis

TEIL 1

AS REIFEN	16
Umrüstabelle AS Bereifung	18
AS Frontreifen	28
AS Reifen Diagonal	30
Industrie Traktorreifen	38
AS Reifen Radial	40
KOMMUNALREIFEN	110
Kommunalreifen	112
FORSTREIFEN	122
Forstreifen	124
Forstreifen Flotation	130
TRAKTOR GOLF RASENPFLEGE	136
Traktor Golf Rasenpflege	138
IMPLEMENTREIFEN	142
Implementreifen	144
Anhängerreifen LKW Diagonal	162
Anhängerreifen LKW Radial	164
FLOTATIONREIFEN	166
Aufbau und Übersicht Flotationreifen	168
Flotationreifen Diagonal	176
Flotationreifen Radial	182
Straßenwalzenreifen	196
Industrie Traktorreifen	198
IMPLEMENT -/FLOTATIONRÄDER	200
Implementräder	202
Anhängerräder runderneuert	210
Anhängerräder Windpower und Sailun	210
Flotationräder Diagonal	214
Flotationräder Radial	222
Flotationräder mit Anchl. f. Reifendruckregelanlage	242
Flotationräder für Agrotucks	244
MPT REIFEN	246
MPT Reifen Diagonal	248
MPT Reifen Radial	254
Skidloaderreifen	266
EM- UND BAGGERREIFEN	268
EM Baggerreifen	270
EM Reifen Diagonal	272
EM Reifen Radial	274
INDUSTRIEREIFEN	278
Industriereifen	280
LANDSCHAFTSPFLEGE, HOF & FREIZEIT	284
Transport - Luftreifen	286
Heumaschinenreifen	290
Rasenreifen	294
Traktor Golf Rasenpflege	296

FELGEN	314
Traktorfelgen	316
Felgen Transportgeräte und Karren	318
Implementfelgen	322
Flotationfelgen	331
Felgen für Reifendruckregelanlage	336
Forstfelgen	340
Industriefelgen	340
EM-Felgen	341
SCHLÄUCHE	342
Schläuche	344
Wulstbänder	371
Dichtringe und Zwischenringe	372

TEIL 2

GRUNDLAGEN REIFEN	374
Reifenaufbau	376
Reifenherstellung	378
Reifenbeschriftungen	379
Tragfähigkeit- u. Geschwindigkeitsindex	380
Reifenhandling und Gewicht	382
BODENSCHONUNG - EINSATZOPTIMIERUNG	384
Bodenschonung	386
Erklärung von Fachbegriffen	388
V-Flecto	390
Luftdruckeinstellung	392
Einsatzoptimierung im Betrieb	394
MONTAGE VON LANDWIRTSCHAFTSREIFEN	396
Montage Landwirtschaftsreifen	398
Sicherer Radwechsel	401
UMBEREIFUNG UND BALLASTIERUNG	402
Umbereifung und Vorlaufverhältnis	404
Voreilung	406
Umrüstabelle	408
Ballastierung von Rädern	420
GRUNDLAGEN FELGEN	424
Übersicht Felgentypen	426
Bezeichnungen und Abmessungen	428
Einpresstiefen	430
Bolzenlöcher-, Ausführungen-, Bezeichnungen	431
Räder- und Felgenmaße	434
TRAKTORFELGEN, ZWILLINGSFELGEN	436
Traktor Anfertigungsfelgen	438
Felgen mit hohen Einpresstiefen	439
Felgen mit Topfkonstruktion	440
Spurverbreiterung	441
Forstfelgen - individuell	443
Zwillingsfelgen Systeme	444
Zwillingskupplungen	450

18

Umrüstabelle AS Bereifung

28

AS Frontreifen

30

AS Reifen Diagonal

38

Industrie Traktorreifen

40

AS Reifen Radial



AS REIFEN



SERVICE-PLUS BY BOHNENKAMP

Erhalten Sie direkten Zugriff
auf unseren Online-Shop



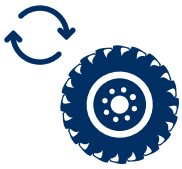

Umrüstabelle AS-Bereifung

Bitte beachten: Bei jeder Neu- bzw. Umbereifung des Schleppers muss der Vorlauf überprüft werden!

Höhe in mm	Standardreifen		Serie 70	Breitreifen Serie 65	Sonderbreiten auf Messfelge
	Zoll	Metrisch			
760-780	6.50 - 16	180/95 R 16	260/70 R 16		
792-844	7.50 R 16	250/80 - 16	280/70 R 16		
773-790	10 R 16.5				
821-865	12 R 16.5				
849-875	7.50 R 18	250/80 - 18	280/70 R 18	320/65 R 18	11 LR 16
899-920	10.5 R 18	280/80 R 18	325/70 R 18	340/65 R 18	
978-1001	12.5 R 18	335/80 R 18 340/80 R 18	365/70 R 18		
987-1002	12.5/80 R 18				
1021-1025	16.0/70 R 18				
890-918	7.50 R 20	250/80 R 20	280/70 R 20		400/55 - 17.5 280/80 R 18 325/70 R 18 340/65 R 18
937-960	9.5 R 20	250/85 R 20	300/70 R 20	340/65 R 20	
950-1010	10.5 R 20	275/80 R 20 280/80 R 20	320/70 R 20		365/70 R 18
975-1010	11.2 R 20	280/85 R 20	320/70 R 20		365/70 R 18
1036-1064	12.4 R 20	320/85 R 20	360/70 R 20	420/65 R 20	
1030-1068	12.5 R 20	335/80 R 20 340/80 R 20	375/70 R 20	420/65 R 20	340/75 R 20
1058-1102	14.5 R 20	375/75 R 20	400/70 R 20 405/70 R 20		375/75 R 20 380/75 R 20
1058-1082	16.0/70 R 20				
975-1010	8.3 R 24	220/85 R 24 210/90 R 24			365/70 R 18 320/70 R 20
1032-1068	9.5 R 24	250/85 R 24	300/70 R 24		320/85 R 20 335/80 R 20 340/75 R 20 360/70 R 20 420/65 R 20

Technische Änderungen / Abweichungen / Ergänzungen vorbehalten

Alles auf einen Blick:

	Pfl gereifen		Kommunalreifen 65/70/80er Serie
	Zoll	Metrisch	
		180/95 R 16	260/70 R 16 315/55 R 16
	7.50 //	210/95 R 16	250/80 R 16 280/70 R 16
			265/70 R 16.5 305/70 R 16.5
	7.50 //	210/95 R 18	280/70 R 18
			340/80 R 18 340/80 R 18 405/70 R 18
	8.3 //	210/90 R 20 8.3 // 210/95 R 20	
	9.5 //	250/85 R 20	300/70 R 20
	8.3 //	210/90 R 24	320/70 R 20
	8.3 //	210/90 R 24	
	9.5 //	250/85 R 24	
	9.5 //	250/85 R 24	340/80 R 20
	11.2 //	280/85 R 24	360/80 R 20 400/70 R 20
			400/70 R 20 405/70 R 20

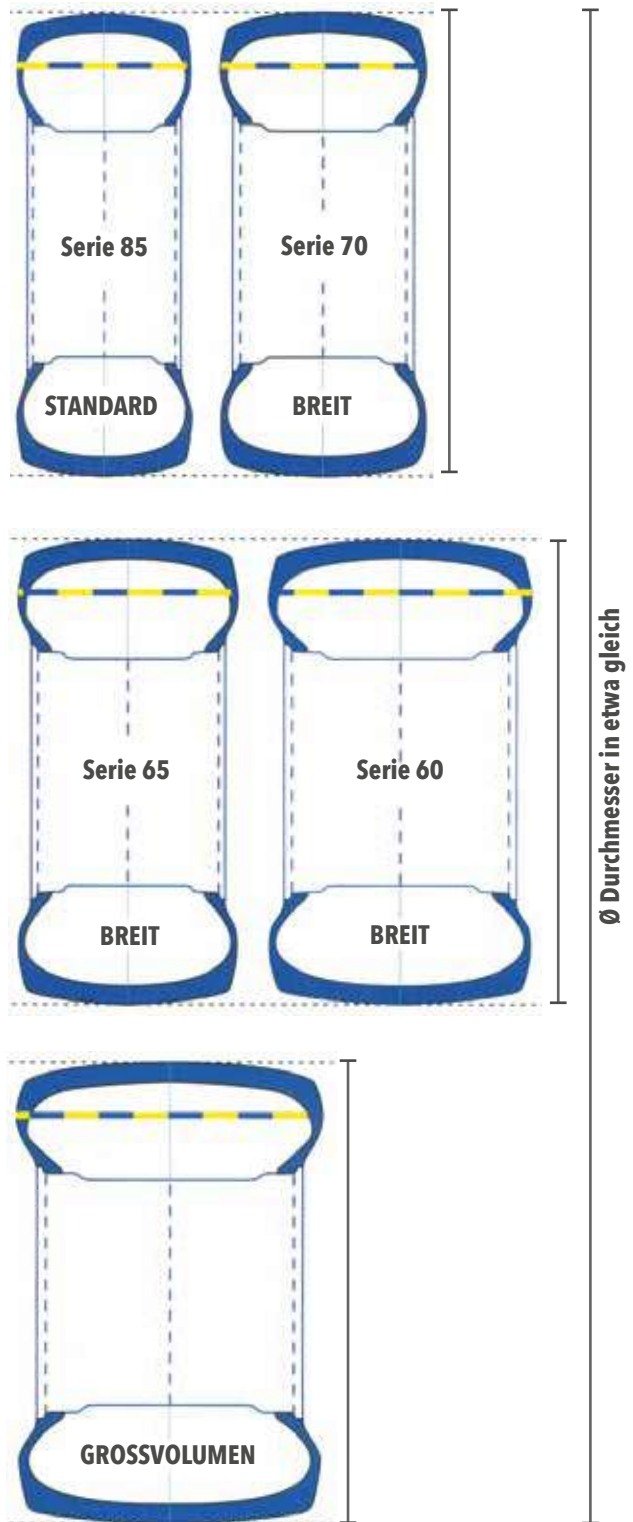

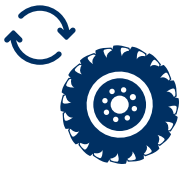

Umrüstabelle AS-Bereifung

Bitte beachten: Bei jeder Neu- bzw. Umbereifung des Schleppers muss der Vorlauf überprüft werden!

Höhe in mm	Standardreifen			Serie 70	Breitreifen Serie 65	Sonderbreiten auf Messfelge
	Zoll	Metrisch				
1082-1115	11.2 R 24	280/85 R 24		320/70 R 24		375/75 R 20 (14.9 LR 20) 380/70 R 20 380/75 R 20 400/70 R 20 405/70 R 20
1138-1223	12.4 R 24	320/85 R 24		360/70 R 24	420/65 R 24	425/75 R 20 600/50 - 22.5 400/70 R 24 405/70 R 24 400/60 - 26.5
1181-1220	13.6 R 24	340/85 R 24		380/70 R 24	440/65 R 24	
1225-1266	14.9 R 24	380/85 R 24		420/70 R 24	480/65 R 24	445/70 R 24 460/70 R 24 (17.5 LR 24)
1283-1345	16.9 R 24	420/85 R 24		480/70 R 24	540/65 R 24	495/70 R 24 500/70 R 24 (19.5 LR 24) 600/55 - 26.5 700/50 - 26.5 440/65 R 28
1290-1345	14.9 R 26	380/85 R 26				500/70 R 24 (19.5 LR 24) 540/65 R 24 380/70 R 28
1345-1384	16.9 R 26	420/85 R 26		480/70 R 26	540/65 R 26	
1400-1467	18.4 R 26	460/85 R 26		520/70 R 26		520/80 R 26 580/70 R 26 480/70 R 28 540/65 R 28
1550-1646	23.1 - 26	620/75 R 26				600/70 R 30 710/60 R 30
1542-1646	28 LR 26				750/65 R 26	600/70 R 30 710/60 R 30
1094-1115	8.3 R 28					320/70 R 24
1137-1154	9.5 R 28	250/85 R 28				360/70 R 24
1182-1220	11.2 R 28	280/85 R 28		320/70 R 28		380/70 R 24 405/70 R 24 440/65 R 24
1225-1266	12.4 R 28	320/85 R 28		360/70 R 28	420/65 R 28	460/70 R 24 (17.5 LR 24)

Alles auf einen Blick:

	Pflegereifen		Kommunalreifen 65/70/80er Serie
	Zoll	Metrisch	
	8.3	// 210/95 R 28	300/80 R 24
	9.5	// 250/85 R 28	340/80 R 24
	8.3	// 210/95 R 32	360/70 R 24 420/65 R 24
	11.2	// 280/85 R 28	360/80 R 24
	8.3	// 210/95 R 32	380/70 R 24 460/65 R 24
	12.4	// 320/85 R 28	400/80 R 24
	9.5	// 230/95 R 32	420/70 R 24
	11.2	// 270/80 R 32	460/70 R 24 (17.5 LR 24) 480/65 R 24
	11.2	// 270/95 R 32	440/80 R 24
	8.3	// 210/95 R 36	500/70 R 24 (19.5 LR 24) 540/65 R 24
	11.2	// 270/95 R 32	500/70 R 24 (19.5 LR 24)
	8.3	// 210/95 R 36	
	9.5	// 230/95 R 36	
	12.4	// 320/85 R 32	
	11.2	// 270/95 R 36	480/80 R 26
	12.4	// 320/85 R 34	
	9.5	// 230/95 R 44	
	11.2	// 270/95 R 42	
	8.3	// 210/95 R 28	300/80 R 34
	9.5	// 250/85 R 28	
	11.2	// 280/85 R 28	
	9.5	// 230/95 R 32	320/85 R 28
	11,2	// 270/80 R 32	

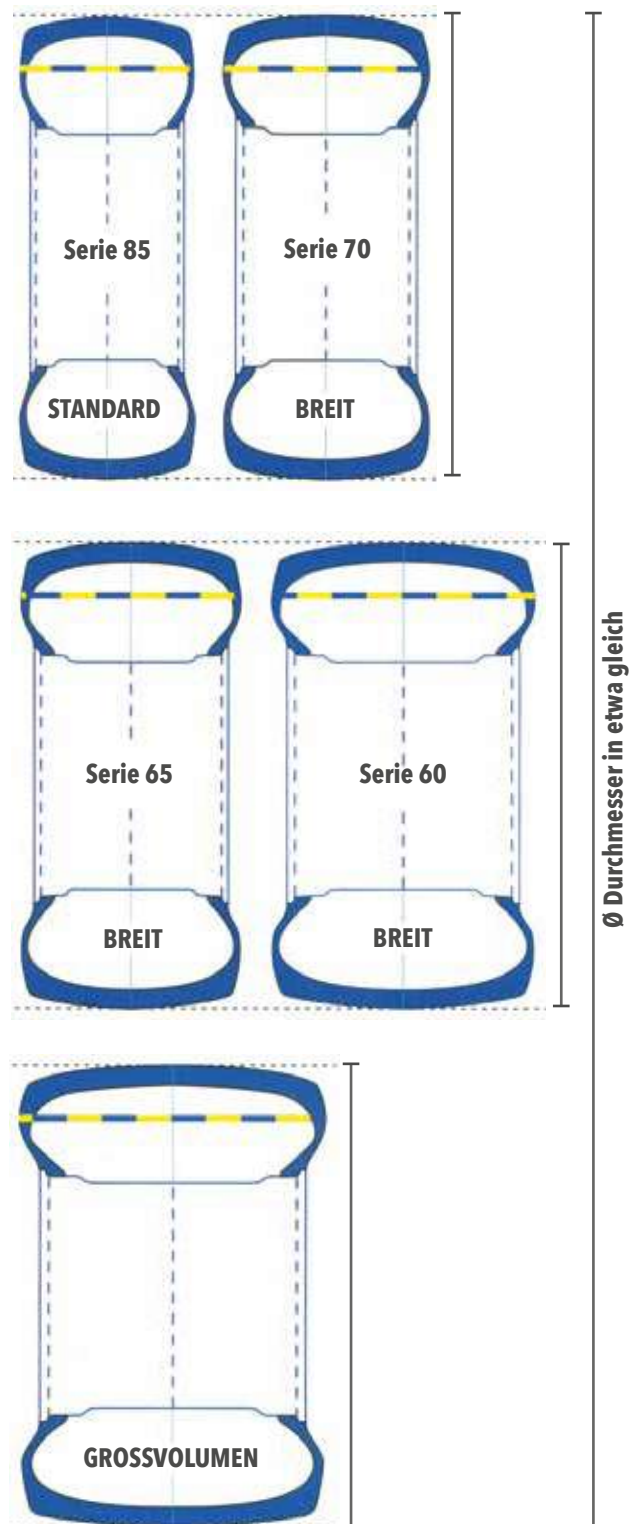

Technische Änderungen / Abweichungen / Ergänzungen vorbehalten

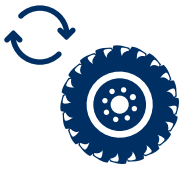

Umrüstabelle AS-Bereifung

Bitte beachten: Bei jeder Neu- bzw. Umbereifung des Schleppers muss der Vorlauf überprüft werden!

Höhe in mm	Standardreifen			Serie 70	Breitreifen Serie 65	Sonderbreiten auf Messfelge
	Zoll	Metrisch				
1283-1345	13.6 R 28	340/85 R 28		380/70 R 28	440/65 R 28	480/60 R 28 480/70 R 24 495/70 R 24 500/70 R 24 (19.5 LR 24) 600/55 - 26.5
1335-1366	14.9 R 28	380/85 R 28		420/70 R 28	480/65 R 28	480/65 R 28 520/60 R 28
1391-1450	16.9 R 28	420/85 R 28		480/70 R 28	540/65 R 28	480/80 R 26 580/70 R 26 420/85 R 28 540/65 R 28 600/60 R 28
1391-1450	14.9 R 30	380/85 R 30		420/70 R 30		580/70 R 26 420/85 R 28 480/70 R 28 540/65 R 28
1446-1503	16.9 R 30	420/85 R 30		480/70 R 30	540/65 R 30	620/70 R 26 600/65 R 28 540/65 R 30 600/60 R 30 600/60 - 30.5
1495-1636	18.4 R 30	460/85 R 30		520/70 R 30	600/65 R 30	620/75 R 26 750/65 R 26 600/65 R 30 600/70 R 28 710/55 R 30
1660-1721	23.1 R 30			620/75 R 30		1000/50 R 25 650/75 R 30
1290-1366	12.4 R 32	320/85 R 32				420/70 R 28 480/65 R 28
1789-1825	24.5 R 32			650/75 R 32		
1820-1865	30.5 LR 32				800/65 R 32	680/75 R 32 800/65 R 32
1350-1550	14.9 R 34	380/85 R 34				460/85 R 30
1543-1646	16.9 R 34	420/85 R 34		480/70 R 34	540/65 R 34	620/75 R 26 750/65 R 26 600/70 R 30 710/60 R 30 750/55 R 30 540/65 R 34

Alles auf einen Blick:

	Pflegereifen		Kommunalreifen 65/70/80er Serie
	Zoll	Metrisch	
	11.2 // 8.3	270/95 R 32 210/95 R 36	360/80 R 28
	12.4 // 9.5 // 9.5	320/85 R 32 230/95 R 36 270/80 R 36	400/80 R 28 480/65 R 28
		320/90 R 32 290/95 R 34	440/80 R 28 540/65 R 28
	12.4 // 11.2	320/85 R 34 270/95 R 36	
		320/90 R 32 290/95 R 34	
	12.4 // 11.2 // 9.5	320/85 R 34 270/95 R 36 230/95 R 40	440/80 R 30 540/65 R 30
	12.4 // 9.5 // 8.3	320/85 R 38 230/95 R 42 210/95 R 44	480/80 R 30
	8.3 // 11.2	210/95 R 36 270/80 R 36	
	12.4 // 9.5	320/85 R 36 230/95 R 42	
	13.6 // 11.2 // 11.2 // 9.5	340/85 R 38 270/95 R 42 300/85 R 42 230/95 R 44	440/80 R 34

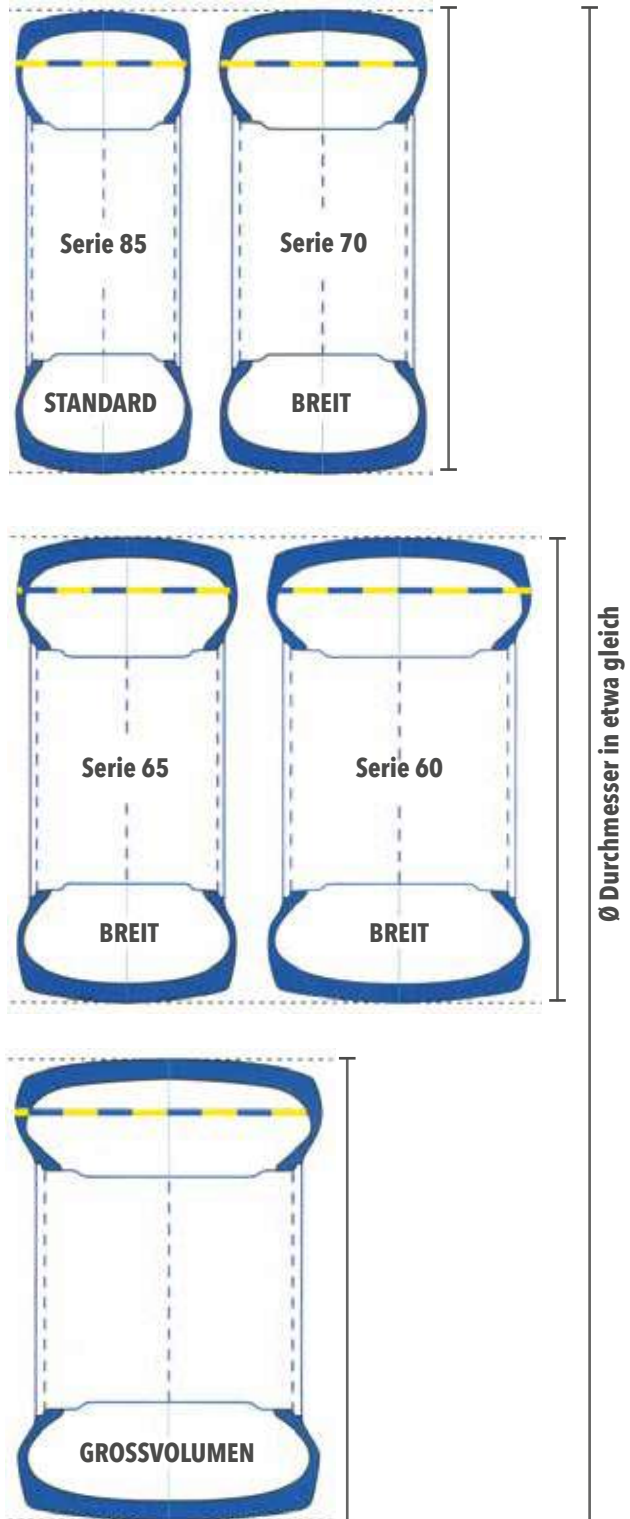

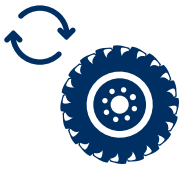

Umrüstabelle AS-Bereifung

Bitte beachten: Bei jeder Neu- bzw. Umbereifung des Schleppers muss der Vorlauf überprüft werden!

Höhe in mm	Standardreifen			Serie 70	Breitreifen Serie 65	Sonderbreiten auf Messfelge
	Zoll		Metrisch			
1605-1710	18.4 R 34		460/85 R 34	520/70 R 34	600/65 R 34	1000/50 R 25 620/75 R 30 600/65 R 34 700/55 R 34 800/50 R 34
1789-1825	23.1 R 34					650/75 R 32 620/75 R 34
1446-1496	12.4 R 36		320/85 R 36			480/70 R 30 540/65 R 30
1492-1581	13.6 R 36		340/85 R 36			620/70 R 26 600/70 R 28 520/70 R 30
1530-1605	13.6 R 38		340/85 R 38			460/85 R 30 600/65 R 30 480/70 R 34 540/65 R 34
1590-1646	14.9 R 38		380/85 R 38			620/75 R 26 600/70 R 30 710/60 R 30
1550-1605	15.5 R 38		400/75 R 38			540/65 R 34
1638-1721	16.9 R 38		420/85 R 38	480/70 R 38	540/65 R 38	620/75 R 30 650/70 R 30 600/70 R 34 650/60 R 34 650/65 R 34 600/60 R 38
1696-1825	18.4 R 38		460/85 R 38	520/70 R 38	600/65 R 38	650/75 R 32 (24.5 R 32) 710/60 R 34 600/65 R 38 650/60 R 38
1820-1906	20.8 R 38		520/85 R 38	580/70 R 38	650/65 R 38	800/65 R 32 1050/50 R 32 620/75 R 34 520/85 R 38 620/70 R 38 650/65 R 38 710/60 R 38

Technische Änderungen / Abweichungen / Ergänzungen vorbehalten

Alles auf einen Blick:

	Pfl gereifen		Kommunalreifen 65/70/80er Serie
	Zoll	Metrisch	
	12.4 // 11.2	300/95 R 42 320/90 R 42 270/95 R 44	480/80 R 34
	9.5	230/95 R 40	
	12.4	320/85 R 38	
	11.2 // 11.2 // 9.5	270/95 R 42 300/85 R 42 230/95 R 44	
	12.4 // 11.2	300/95 R 42 320/90 R 42 270/95 R 44	
	9.5	230/95 R 44	
	11.2	270/95 R 46	
	9.5	230/95 R 48	
	12.4 // 12.4 // 13.6 // 11.2	300/95 R 46 320/90 R 46 340/85 R 46 270/95 R 48	480/80 R 38 600/65 R 38
		480/80 R 42 460/85 R 42 320/105 R 46	540/80 R 38 650/65 R 38
	14.9 // 13.6 // 12.4	380/90 R 46 420/80 R 46 340/85 R 48 320/90 R 50	

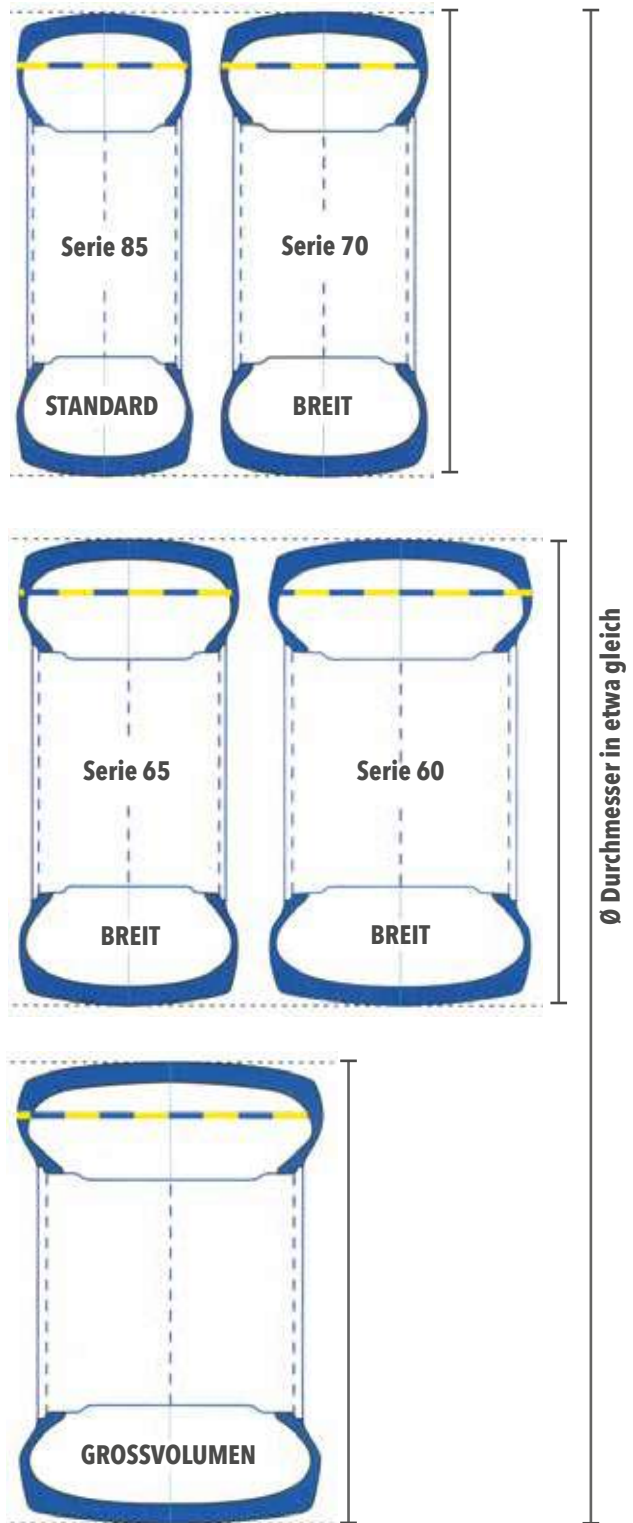

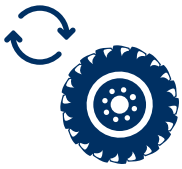

Umrüstabelle AS-Bereifung

Bitte beachten: Bei jeder Neu- bzw. Umbereifung des Schleppers muss der Vorlauf überprüft werden!

Höhe in mm	Standardreifen		Serie 70	Breitreifen Serie 65	Sonderbreiten auf Messfelge
	Zoll	Metrisch			
1820 bis 1865	18.4 R 42	460/85 R 42 480/80 R 42		600/65 R 42	680/75 R 32 710/75 R 32 800/65 R 32
1900 bis 1960	20.8 R 42	520/85 R 42	580/70 R 42 620/70 R 42	650/65 R 42	680/85 R 32 800/70 R 32 900/60 R 32 710/75 R 34 650/75 R 38 710/70 R 38 710/60 R 42 900/50 R 42
1933 bis 1970	18.4 R 46	460/85 R 46 480/80 R 46			680/85 R 32 800/70 R 32 680/75 R 38 620/70 R 42 900/50 R 42
2000 bis 2120	20.8 R 46	520/85 R 46	620/70 R 46		900/70 R 32 650/85 R 38 710/75 R 38 800/70 R 38 900/55 R 38 900/60 R 38 580/85 R 42 650/75 R 42 710/70 R 42 620/70 R 46 710/65 R 46
2140 bis 2195	20.8 R 50	520/85 R 50			710/85 R 38 650/85 R 42 680/80 R 42 710/75 R 42 800/70 R 42 900/60 R 42 750/70 R 44
2290 bis 2320					750/75 R 46 900/65 R 46

Technische Änderungen / Abweichungen / Ergänzungen vorbehalten

Alles auf einen Blick:

	Pflegereifen		Kommunalreifen 65/70/80er Serie
	Zoll	Metrisch	
		320/105 R 46	540/80 R 38
	14.9 //	380/90 R 46	650/65 R 38
	16.9 //	420/80 R 46	
	12.4 //	320/90 R 50	
		480/80 R 46	
	14.9 //	380/90 R 50	
	12.4 //	300/95 R 52	
		230/115 R 54	
	11.2 //	270/95 R 54	650/65 R 42
		270/105 R 54	
	12.4 //	320/90 R 54	
	14.9 //	380/90 R 50	
	12.4 //	300/95 R 52	650/65 R 42
		230/115 R 54	
	11.2 //	270/95 R 54	
		270/105 R 54	
	12.4 //	320/90 R 54	
		380/105 R 50	650/85 R 38
		420/95 R 50	
	18.4 //	480/80 R 50	620/80 R 42
	14.9 //	380/90 R 54	710/70 R 42
		480/95 R 50	

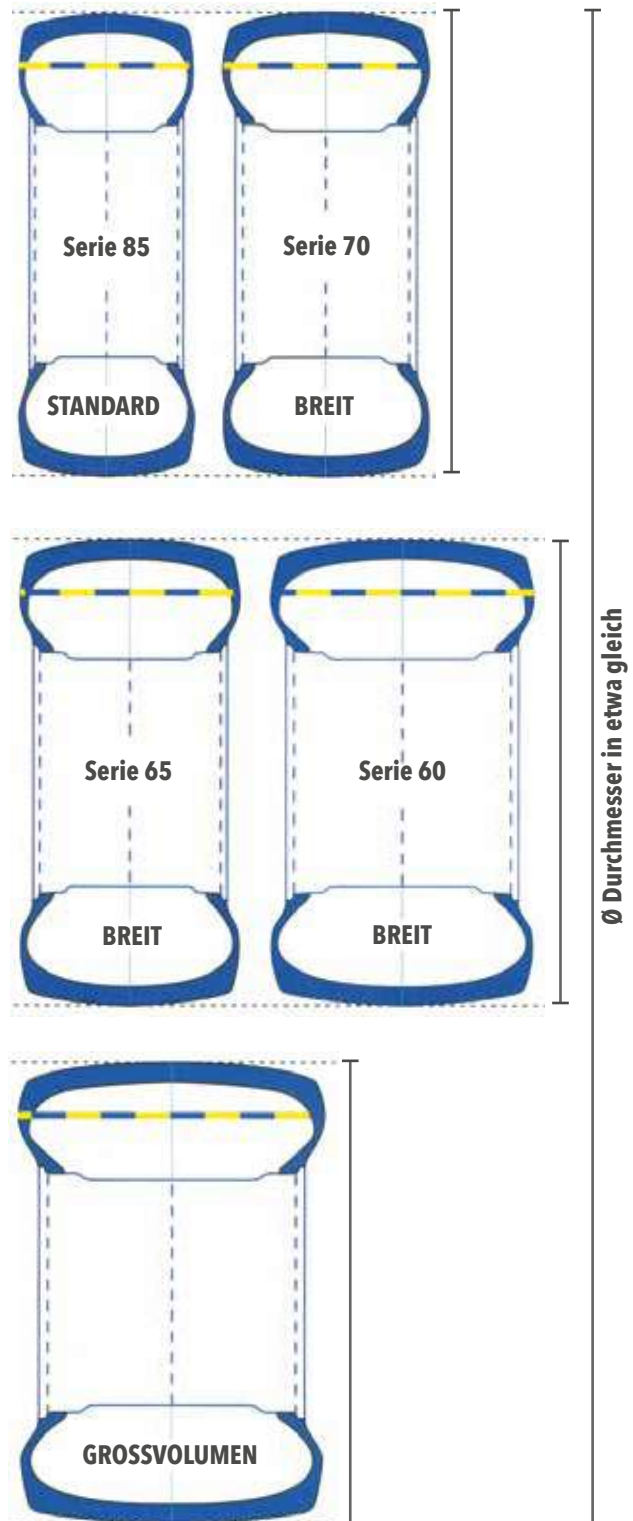







AS Frontreifen

Preise und Bestände finden Sie unter www.bohnenkamp.de/shop

Artikel-Nr.	Größe	Last-/ Speed-Index	PR	TL/ TT	Profil	Marke	Felge ¹	Breite in mm	Außen ø in mm
15721010	4.00 - 12	68 A6/60 A8	6 PR	TT	TF 9090	BKT	3.00/2.50	112	530
15721025	4.00 - 15	66 A6/59 A8	4 PR	TT	TF 8181	BKT	3.00	112	605
15721032	5.00 - 15	82 A6/74 A8	6 PR	TT	TF 9090	BKT	4.00	140	655
15721035	5.00 - 15	82 A6/74 A8	6 PR	TT	TF 8181	BKT	4.00	142	655
15721038	4.00 - 16	69 A6/61 A8	4 PR	TT	TF 8181	BKT	3.00	112	630
15721037	4.00 - 16	69 A6/62 A8	4 PR	TT	TF 9090	BKT	3.00	112	630
15721040	4.50 - 16	73 A6/65 A8	4 PR	TT	TF 8181	BKT	3.00	122	655
15721045	5.00 - 16	84 A6/76 A8	6 PR	TT	TF 8181	BKT	4.00	140	680
15721050	5.50 - 16	86 A6/78 A8	6 PR	TT	TF 8181	BKT	4.00/3.50/4.50	158	720
15721055	5.50 - 16	86 A6/78 A8	6 PR	TT	TF 9090	BKT	4.00/3.50/4.50	150	710
15721090	6.00 - 16	88 A6/80 A8	6 PR	TT	TF 9090	BKT	4.50/4.00/5.00	170	735
15721095	6.00 - 16	88 A6/80 A8	6 PR	TT	TF 8181	BKT	4.50/4.00/5.00	170	745
15721097	6.00 - 16	94 A6/87 A8	8 PR	TT	TF 8181	BKT	4.50/4.00/5.00	170	745
15721350	6.00 - 16	94 A6/87 A8	8 PR	TT	Steer Farm	BKT	4.50/4.00/5.00	170	740
15721107	6.50 - 16	91 A6/83 A8	6 PR	TT	TF 8181	BKT	4.50/4.00/5/5.00/5.50	180	770
15721105	6.50 - 16	91 A6/83 A8	6 PR	TT	TF 9090	BKT	4.50/4.00/5/5.00/5.50	180	765
15721108	6.50 - 16	98 A6/90 A8	8 PR	TT	TF 8181	BKT	4.50/4.00/5/5.00/5.50	180	770
15721120	7.50 - 16	98 A6/90 A8	6 PR	TT	TF 8181	BKT	5.50/5.00/6.00	205	820
15721110	7.50 - 16	98 A6/90 A8	6 PR	TT	TF 9090	BKT	5.50/5.00/6.00	207	810
15721122	7.50 - 16	103 A6/95 A8	8 PR	TT	TF 8181	BKT	5.50/5.00/6.00	205	820
15721115	7.50 - 16	103 A6/96 A8	8 PR	TT	TF 9090	BKT	5.50/5.00/6.00	207	810
15721360	7.50 - 16	103 A6/96 A8	8 PR	TT	Steer Farm	BKT	5.50/5.00/6.00	205	805
15721130	9.00 - 16	116 A6/108 A8	10 PR	TT	TF 9090	BKT	8/6.00/7	257	855
15721145	10.00 - 16	115 A6/107 A8	8 PR	TT	TF 8181	BKT	8	273	895
15721140	10.00 - 16	115 A6/107 A8	8 PR	TT	TF 9090	BKT	8	275	900
15721415	10.00 - 16 SL	110 A8	8 PR	TT	Pro Rib F2M	BKT	8	280	880
15721160	11.00 - 16	118 A6/110 A8	8 PR	TT	TF 8181	BKT	10/8	326	980
15721150	11.00 - 16	118 A6/110 A8	8 PR	TT	TF 9090	BKT	10/8	320	970
15721420	11.00 - 16 SL	114 A8	8 PR	TT	Pro Rib F2M	BKT	10/8	335	950
15721190	6.00 - 18	101 A6/94 A8	8 PR	TT	TF 8181	BKT	4.50	172	800
15721210	7.50 - 18	106 A6/98 A8	8 PR	TT	TF 8181	BKT	5.50	208	875
15721200	7.50 - 18	106 A6/96 A8	8 PR	TT	TF 9090	BKT	5.50	207	860
15721230	4.00 - 19	72 A6/64 A8	4 PR	TT	TF 9090	BKT	3.00	115	715
15721245	6.00 - 19	93 A6/85 A8	6 PR	TT	TF 8181	BKT	4.50/4.00/5.00	165	814
15721240	6.00 - 19	93 A6/85 A8	6 PR	TT	TF 9090	BKT	4.50/4.00/5.00	167	815
15721248	6.50 - 20	97 A6/89 A8	6 PR	TT	TF 8181	BKT	5.00/4.00	180	865
15721249	6.50 - 20	101 A6/93 A8	8 PR	TT	TF 8181	BKT	5.00/4.00/5.50	180	865
15721255	7.50 - 20	103 A6/96 A8	6 PR	TT	TF 8181	BKT	5.50/5.00	205	915
15721257	7.50 - 20	109 A6/101 A8	8 PR	TT	TF 8181	BKT	5.50/5.00	205	915
15721250	7.50 - 20	109 A6/101 A8	8 PR	TT	TF 9090	BKT	5.50/5.00	205	915
19922100	9.00 - 20	111 A8	6 PR	TT	VL-45	Voltyre	7/5.50	234	930

¹ = empfohlene Felge / weitere zulässige Felgenbreiten

Alles auf einen Blick:

 statischer Halbmesser in mm	 Abrollumfang in mm	 Tragfähigkeit in kg	 km/h	 Luftdruck in bar
255	1573	315/250	30/40	5,10
287	1834	300/243	30/40	3,40
307	1951	475/375	30/40	3,70
307	1951	530/375	30/40	3,80
301	1877	325/257	30/40	2,40/3,40
301	1877	325/265	30/40	3,40
311	1952	365/290	30/40	3,10
322	2025	500/400	30/40	4,20
340	2145	530/425	30/40	3,70
332	2116	530/425	30/40	3,70
346	2190	560/450	30/40	3,30
350	2220	560/450	30/40	3,30
350	2220	670/545	30/40	4,50
353	2279	670/545	30/40	4,50
361	2295	615/487	30/40	3,10
359	2280	615/487	30/40	3,10
361	2295	750/600	30/40	4,20
383	2445	750/600	30/40	2,80
379	2414	750/600	30/40	2,80
383	2445	875/690	30/40	3,70
379	2414	875/710	30/40	3,70
378	2451	875/710	30/40	3,70
398	2548	1250/1000	30/40	3,90
411	2667	1215/975	30/40	2,80
418	2682	1215/975	30/40	2,80
409	2620	1060	40	3,00
447	2920	1320/1060	30/40	2,50
448	2890	1320/1060	30/40	2,50
440	2830	1180	40	2,80
374	2410	825/670	30/40	4,20
410	2605	950/750	30/40	3,70
404	2562	950/710	30/40	3,70
343	2145	355/280	30/40	3,40
385	2425	650/515	30/40	3,30
386	2445	650/515	30/40	3,30
409	2578	730/580	30/40	3,10
409	2578	825/650	30/40	3,90
431	2725	875/710	30/40	2,80
431	2725	1030/825	30/40	3,40
431	2725	1030/825	30/40	3,40
430		1090	40	2,40



BKT Pro Rib F2M



BKT Steer Farm

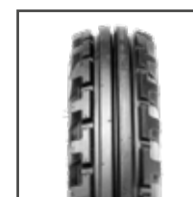

BKT TF 8181



BKT TF 9090



Voltyre VL-45





AS Reifen Diagonal





Preise und Bestände finden Sie unter www.bohnenkamp.de/shop

Artikel-Nr.	Größe	Last-/ Speed-Index	PR	TL/ TT	Profil	Marke	Felge ¹	Breite in mm	Außen ø in mm
19111103	4.00 - 12	54 A6/66 A6*	4 PR	TT	S-247	Deli	3.00	110	516
15722030	6.00 - 12	76 A6/72 A8	6 PR	TT	TR 171	BKT	4.00/4	160	635
15710507	26x12.00 - 12	112 A6	8 PR	TL	AS 504	BKT	10.50/8.0/8.5/9.0	310	648
13612155	5.00 - 14	73 A8		TT	IM110	Trelleborg	3.00/3.50/4.00/4	130	636
15711680	5.00 - 15	75 A8/88 A8*	6 PR	TT	AS 504	BKT	3.50/3.00/4.00	140	657
15711686	6.5/80 - 15	92 A8/104 A8*	8 PR	TL	AS 505	BKT	5.0/4.50/5	169	683
15221125	195/65 - 15	93 A8	8 PR	TL	768	Alliance	5.5	200	665
15711690	7.5L - 15	100 A8/113 A8*	8 PR	TT	AS 504	BKT	6/5/5.50	210	765
10913020	28x9.00 - 15	102 A5	6 PR	TT	AC 30	Mitas	7/6.50	234	710
15710565	400/50 - 15	109 A8/121 A8*	8 PR	TL	AS 504	BKT	13	395	790
15711722	4.00 - 16	66 A8/78 A8*	4 PR	TT	AS 504	BKT	3.00	110	628
19111131	5.00 - 16	76 A8	6 PR	TT	SG-811	Deli	4.0	144	701
15711823	6.00 - 16	83 A8/95 A8*	6 PR	TT	AS 504	BKT	4.00/4.50	164	735
13612170	6.50 - 16	105 A8		TT	IM110	Trelleborg	5.50/4.5/5.00/6.50	183	762
15711708	7 - 16	75 A6/71 A8	4 PR	TT	TR 144	BKT	6/6.00	183	740
15711828	7.50 - 16	99 A8/112 A8*	8 PR	TT	AS 504	BKT	5.50/4.00/4.50/5.0/6/6.00	209	803
15711829	7.50 - 16	99 A8/112 A8*	8 PR	TL	AS 504	BKT	5.50/4.00/4.50/5.0/6/6.00	209	803
15222052	8 - 16	91 A6	6 PR	TT	FarmPRO 324	Alliance	6	201	790
15711709	8 - 16	91 A6/88 A8	6 PR	TT	TR 144	BKT	6/6.00	200	785
13612200	9.0/75 - 16	111 A8		TT	IM110	Trelleborg	8/7	225	780
15711827	250/80 - 16	113 A8/125 A8*	8 PR	TT	Farm 2000	BKT	8/7/9	240	820
15211659	8.25 - 16	109 A6/105 A8	6 PR	TT	324	Alliance	6.00	229	818
15722040	9.5 - 16	96 A6/92 A8	6 PR	TT	TR 171	BKT	8	241	845
15722043	9.5 - 16	96 A6/92 A8	6 PR	TT	TR 144	BKT	8	245	850
15722049	12.4 - 16	97 A6/93 A8	4 PR	TT	TR 135	BKT	11/9/10	326	960
15711867	420/55 - 17	133 A8/145 A8*	16 PR	TL	AS 504	BKT	13	430	910
10000690	400/55 - 17.5	125 A8/122 B		TL	T414	Trelleborg	11.75	400	880
15222070	7.00 - 18	123 A6/120 A8	6 PR	TT	324	Alliance	5.00/5.50	178	803
15712390	7.50 - 18	101 A8/114 A8*	8 PR	TT	AS 504	BKT	5.50	209	854
13612180	7.50 - 18	106 A8		TT	IM110	Trelleborg	5.5/4.50/5.00/6.00	203	870
15712395	8 - 18	94 A6/90 A8	6 PR	TT	TR 144	BKT	6/5.50/7	195	840
15712392	250/80 - 18	115 A8/127 A8*	8 PR	TT	Farm 2000	BKT	8/7/9	240	870
15731050	10.5 - 18	131 A8/130 B	10 PR	TL	MP 600	BKT	9	272	920
15731065	12.5 - 18	132 B	10 PR	TL	MP 600	BKT	11/12	308	990
15731067	12.5 - 18	136 B	12 PR	TL	MP 600	BKT	11/12	308	990
15712450	7.50 - 20	103 A8/116 A8*	8 PR	TT	AS 504	BKT	5.50/4.50/5.00/6.00	209	904
15222075	8.00 - 20	111 A6	8 PR	TT	FarmPRO 324	Alliance	5.5	220	965

* = höhere Tragfähigkeit für Einsatz auf gezogenen Fahrzeugen, niedrigere Tragfähigkeit für Einsatz auf angetriebenen Fahrzeugen

¹ = empfohlene Felge / weitere zulässige Felgenbreiten

Alles auf einen Blick:

 statischer Halbmesser in mm	 Abrollumfang in mm	 Tragfähigkeit in kg	 km/h	 Luftdruck in bar
241	1556	212/300	30	2,75
298	1953	400/355	30/40	2,60
298	1932	1120	30	3,00
292	1913	365	40	2,20
308	1957	387/560	40	3,50
325	2106	630/900	40	4,80
306	1987	650	40	3,20
354	2280	800/1150	40	3,70
322	2160	850	25	2,50
369	2387	1030/1450	40	3,00
296	1935	300/425	40	2,80
329	2081	400	40	3,70
343	2190	487/690	40	2,80
351	2304	925	40	3,70
344	2223	387/345	30/40	1,60
372	2475	750/1120	40	3,20
372	2475	775/1120	40	3,20
361	2350	615	30	1,90
358	2342	615/560	30/40	1,90
349	2330	1090	40	2,60
369	2429	1150/1650	40	2,50
371	2450	1030/925	30/40	2,00
395	2607	710/630	30/40	2,10
388	2558	710/630	30/40	2,10
431	2852	730/650	30/40	1,20
407	2712	2060/2900	40	3,50
408	2640	1650/1500	40/50	2,40
373	2413	1550/1400	30/40	2,00
407	2649	825/1180	40	3,10
399	2626	950	40	2,30
385	2509	670/600	30/40	1,90
394	2679	1215/1750	40	2,80
420	2740	1950/1900	40/50	3,75
450	2950	2000	50	3,00
450	2950	2240	50	3,50
422	2695	875/1250	40	3,20
438	2899	1090	30	2,80



Alliance 324



Alliance FarmPRO 324



Alliance 768



BKT AS 504



BKT AS 505

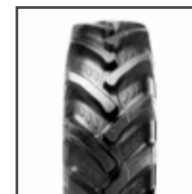

BKT Farm 2000



BKT MP 600

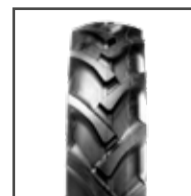

BKT TR 135



BKT TR 144



BKT TR 171



Deli S-247



Deli SG-811

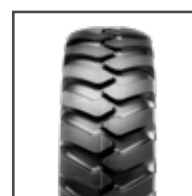

Mitas AC 30



Trelleborg IM110

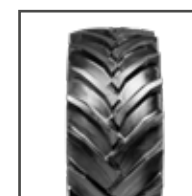

Trelleborg T414







AS Reifen Diagonal

Preise und Bestände finden Sie unter www.bohnenkamp.de/shop

Artikel-Nr.	Größe	Last-/ Speed-Index	PR	TL/ TT	Profil	Marke	Felge ¹	Breite in mm	Außen ø in mm
15722059	8.00 - 20	111 A6/101 A8	8 PR	TT	TR 135	BKT	5.50/6	225	965
15222077	8.3 - 20	96 A6	6 PR	TT	FarmPRO 324	Alliance	7	211	893
15722060	8.3 - 20	96 A6/92 A8	6 PR	TT	TR 144	BKT	7/6	211	890
15222082	9.5 - 20	101 A8	6 PR	TT	FarmPRO 324	Alliance	8	241	940
15722070	9.5 - 20	102 A6/99 A8	6 PR	TT	TR 135	BKT	8/7	240	955
15722074	11.2 - 20	111 A6/107 A8	8 PR	TT	TR 135	BKT	10/9	292	1020
15722075	11.2 - 20	113 A6 /109 A8	8 PR	TT	TR 171	BKT	10/9	285	1005
15722077	12.4 - 20	116 A6/112 A8	8 PR	TT	TR 135	BKT	11/9/10	325	1075
15731163	400/70 - 20	152 A8	14 PR	TL	MP 600	BKT	13/12	405	1085
15722078	8.3 - 22	104 A6/100 A8	8 PR	TT	TR 171	BKT	7	205	945
15722080	9.5 - 22	104 A6/100 A8	6 PR	TT	TR 144	BKT	7/8	235	1000
15222154	8.3 - 24	105 A8	8 PR	TT	FarmPRO 324	Alliance	7	211	995
15722090	8.3 - 24	100 A6/96 A8	6 PR	TT	TR 135	BKT	7/6	211	995
12500820	9.5 - 24	102 A8	6 PR	TL	Turf Pro R-3	Carlisle	8.00/7/8	241	1024
15222172	9.5 - 24	112 A8	8 PR	TT	FarmPRO 324	Alliance	8/7	241	1050
15722095	9.5 - 24	112 A6/108 A8	8 PR	TT	TR 135	BKT	8/7	241	1060
15722096	9.5 - 24	116 A6/112 A8	10 PR	TT	TR 135	BKT	8/7	241	1060
15222191	11.2 - 24	116 A8	8 PR	TT	FarmPRO 324	Alliance	10	284	1105
15722100	11.2 - 24	116 A6/112 A8	8 PR	TT	TR 135	BKT	10/9	284	1105
15222192	12.4 - 24	121 A8	8 PR	TT	FarmPRO 324	Alliance	11	315	1160
15222197	12.4 - 24	129 A8	12 PR	TT	357	Alliance	11/10	315	1160
15722135	12.4 - 24	121 A6/118 A8	8 PR	TT	TR 135	BKT	11/9/10	315	1160
15722137	12.4 - 24	128 A6/124 A8	12 PR	TT	TR 135	BKT	11/9/10	315	1160
15731242	400/70 - 24	153 A8/152 B	14 PR	TL	MP 600	BKT	13/12	405	1185
15722170	13.6 - 24	123 A6/120 A8	8 PR	TT	TR 135	BKT	12/11	355	1220
15222211	13.6 - 24	123 A8	8 PR	TT	FarmPRO 324	Alliance	12	345	1210
15722171	13.6 - 24	130 A6/126 A8	12 PR	TT	TR 135	BKT	12/11	355	1220
15222213	14.9 - 24	128 A8	8 PR	TT	FarmPRO 324	Alliance	13	378	1265
15222214	14.9 - 24	136 A8	12 PR	TT	FarmPRO 324	Alliance	13	378	1265
15722180	14.9 - 24	128 A6/124 A8	8 PR	TT	TR 135	BKT	13/11/12	378	1265
15222268	15.5/80 - 24	157 A6/154 A8	12 PR	TL	324	Alliance	12/14	384	1262
15712495	15.5/80 - 24	145 A8/157 A8*	12 PR	TL	AS 504	BKT	12/13/14	384	1262
15712494	15.5/80 - 24	151 A6	16 PR	TL	Grip Star	BKT	12/13/14	392	1270
15712497	16.5/85 - 24	151 A8/163 A8*	12 PR	TL	AS 504	BKT	13/14/15	415	1325
15712498	16.5/85 - 24	155 A8/168 A8*	16 PR	TL	AS 504	BKT	13/14/15	415	1325
15722190	16.9 - 24	133 A6/129 A8	8 PR	TT	TR 135	BKT	15/14	429	1335
15722191	16.9 - 24	140 A6	12 PR	TT	TR 135	BKT	15/14	429	1335
15222267	16.9 - 24	133 A8	8 PR	TT	FarmPRO 324	Alliance	15	429	1335
15722195	13.6 - 26	120 A6/116 A8	6 PR	TT	TR 171	BKT	12/11	340	1270
15722200	14.9 - 26	129 A6/125 A8	8 PR	TT	TR 135	BKT	13/11/12	375	1315
15722205	16.9 - 26	137 A6/133 A8	10 PR	TT	TR 135	BKT	15/14	430	1380

Alles auf einen Blick:

 statischer Halbmesser in mm	 Abrollumfang in mm	 Tragfähigkeit in kg	 km/h	 Luftdruck in bar
448	2837	1090/825	30/40	2,80
424	2702	710	30	2,40
414	2670	710/630	30/40	2,40
442	2845	825	40	2,10
444	2913	850/775	30/40	2,20
477	3000	1090/975	30/40	2,40
471	3101	1150/1030	30/40	2,60
500	3160	1250/1120	30/40	2,10
494	3271	3550	40	4,00
444	2778	900/800	30/40	3,20
464	3008	900/800	30/40	2,20
470	3020	925	40	3,10
469	2985	800/710	30/40	2,40
472	3061	850	40	2,00
492	3128	1120	40	2,80
502	3234	1120/1000	30/40	2,80
502	3234	1250/1120	30/40	3,50
512	3314	1250	40	2,40
517	3399	1250/1120	30/40	2,40
533	3461	1450	40	2,30
533	3461	1850	40	3,50
543	3573	1450/1320	30/40	2,30
543	3573	1800/1600	30/40	3,50
545	3530	3650/3550	40/50	3,50
562	3698	1550/1400	30/40	2,00
549	3584	1550	40	2,00
562	3698	1900/1700	30/40	2,90/5,90
585	3801	1800	40	1,80
585	3801	2240	40	2,60
576	3837	1800/1600	30/40	1,80
566	3786	4125/3750	30/40	3,00
570	3875	2900/4125	40	3,00
569	3683	3450	30	5,20
591	3837	3450/4875	40	2,80
591	3837	3875/5600	40	3,80
613	3925	2060/1850	30/40	1,70
613	3925	2500	30	2,40
601	3922	2060	40	1,70
580	3774	1400/1250	30/40	1,60
608	3863	1850/1650	30/40	1,80
625	4183	2300/2060	30/40	2,00



Alliance 324



Alliance FarmPRO 324



Alliance 357



BKT AS 504

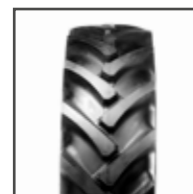

BKT Grip Star

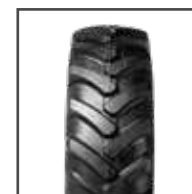

BKT MP 600



BKT TR 135



BKT TR 144



BKT TR 171



Carlisle Turf Pro R-3

* = höhere Tragfähigkeit für Einsatz auf gezogenen Fahrzeugen, niedrigere Tragfähigkeit für Einsatz auf angetriebenen Fahrzeugen

1 = empfohlene Felge / weitere zulässige Felgenbreiten







AS Reifen Diagonal

Preise und Bestände finden Sie unter www.bohnenkamp.de/shop

Artikel-Nr.	Größe	Last-/ Speed-Index	PR	TL/ TT	Profil	Marke	Felge ¹	Breite in mm	Außen ø in mm
15222301	18.4 - 26	146 A8	12 PR	TL	FarmPRO 324	Alliance	16	467	1450
15722210	18.4 - 26	146 A6	12 PR	TT	AS 2001	BKT	16/15	467	1475
15722213	18.4 - 26	149 A6/145 A8	14 PR	TT	AS 2001	BKT	16/15	467	1475
15222371	23.1 - 26	156 A8	14 PR	TT	347	Alliance	20	587	1605
15222372	23.1 - 26	159 A8	16 PR	TT	347	Alliance	20	587	1605
15222376	23.1 - 26	159 A8	16 PR	TL	FarmPRO 324	Alliance	20	587	1600
15722220	23.1 - 26	153 A6/149 A8	12 PR	TL	TR 135	BKT	20	587	1585
15722223	23.1 - 26	159 A6/155 A8	16 PR	TL	TR 135	BKT	20	587	1585
15722301	8.3 - 28	108 A6/104 A8	8 PR	TT	TR 135	BKT	7	213	1104
15722307	9.5 - 28	114 A6/110 A8	8 PR	TT	TR 135	BKT	8/7	235	1155
15222415	11.2 - 28	118 A8	8 PR	TT	FarmPRO 324	Alliance	10	284	1205
15722310	11.2 - 28	118 A6/114 A8	8 PR	TT	TR 135	BKT	10/9	284	1205
15222434	12.4 - 28	125 A8	12 PR	TT	324	Alliance	11/10	315	1260
15222435	12.4 - 28	123 A8	8 PR	TT	FarmPRO 324	Alliance	11/9/10	315	1260
15722334	12.4 - 28	123 A6/120 A8	8 PR	TT	TR 135	BKT	11	325	1260
15222458	13.6 - 28	125 A8	8 PR	TT	FarmPRO 324	Alliance	12	345	1310
15722355	13.6 - 28	125 A6/122 A8	8 PR	TT	TR 135	BKT	12/11	345	1310
15222481	14.9 - 28	130 A8	8 PR	TT	FarmPRO 324	Alliance	13	378	1365
15722410	14.9 - 28	130 A6/126 A8	8 PR	TT	TR 135	BKT	13/11/12	378	1365
15722415	14.9 - 28	137 A6/133 A8	12 PR	TT	TR 135	BKT	13/11/12	378	1365
15222490	16.5/85 - 28	163 A6/159 A8	12 PR	TT	324	Alliance	13/14/15	417	1423
15222531	16.9 - 28	135 A8	8 PR	TT	FarmPRO 324	Alliance	15	429	1435
15722430	16.9 - 28	135 A6/131 A8	8 PR	TT	AS 2001	BKT	15/14	429	1420
15722435	16.9 - 28	143 A6	12 PR	TT	AS 2001	BKT	15/14	429	1420
15722445	7.2 - 30	95 A6/91 A8	6 PR	TT	TR 135	BKT	6	185	1095
15722450	9.5 - 30	115 A6/111 A8	8 PR	TT	TR 135	BKT	8/7	241	1200
15222563	14.9 - 30	132 A8	8 PR	TT	324	Alliance	13/12	378	1415
15722455	14.9 - 30	131 A6/127 A8	8 PR	TT	TR 135	BKT	13/11/12	378	1415
15222577	16.9 - 30	148 A8	14 PR	TT	324	Alliance	15/14	429	1485
15222574	16.9 - 30	137 A8	8 PR	TT	FarmPRO 324	Alliance	15	430	1485
15722460	16.9 - 30	137 A6/132 A8	8 PR	TT	TR 135	BKT	15/14	429	1485
15722462	16.9 - 30	146 A6/143 A8	14 PR	TT	TR 135	BKT	15/14	429	1485
15222580	18.4 - 30	152 A8	14 PR	TT	324	Alliance	16/15	467	1550
15222591	18.4 - 30	139 A8	8 PR	TT	FarmPRO 324	Alliance	16	467	1550
15722470	18.4 - 30	149 A6/145 A8	12 PR	TT	TR 135	BKT	16/15	460	1545
15722471	18.4 - 30	151 A6/147 A8	14 PR	TT	TR 135	BKT	16/15	460	1545
15222682	23.1 - 30	158 A8	14 PR	TT	FarmPRO 324	Alliance	20	587	1700
15722480	23.1 - 30	155 A6/151 A8	12 PR	TT	TR 135	BKT	20	600	1700
15722510	8.3 - 32	105 A6/101 A8	6 PR	TT	TR 135	BKT	7/6	211	1195
15222685	9.5 - 32	106 A8	6 PR	TT	324	Alliance	8/7	241	1250

¹ = empfohlene Felge / weitere zulässige Felgenbreiten

Alles auf einen Blick:

 statischer Halbmesser in mm	 Abrollumfang in mm	 Tragfähigkeit in kg	 km/h	 Luftdruck in bar
646	4244	3000	40	2,30
650	4250	3000	30	2,30
650	4250	3250/2900	30/40	2,60
703	4648	4000	40	2,00
703	4648	4375	40	2,30
720	4769	4375	40	2,30
700	4615	3650/3250	30/40	1,70
700	4615	4375/3875	30/40	2,30
519	3347	1000/900	30/40	3,20
548	3557	1180/1060	30/40	2,80
560	3621	1320	40	2,40
565	3543	1320/1180	30/40	2,40
583	3776	1650	40	2,50
583	3776	1550	40	2,30
584	3876	1550/1400	30/40	2,30
616	4000	1650	40	2,00
606	3908	1650/1500	30/40	2,00
640	4180	1900	40	1,80
634	4170	1900/1700	30/40	1,80
634	4170	2300/2060	30/40	2,60
626	4130	4875/4375	30/40	2,80
660	4305	2180	40	1,70
651	4319	2180/1950	30/40	1,70
651	4319	2725	30	2,40
523	3219	690/615	30/40	2,30
567	3528	1215/1090	30/40	2,80
660	4261	2000	40	1,80
659	4316	1950/1750	30/40	1,80
667	4369	3150	40	2,90
685	4485	2300	40	1,70
678	4535	2300/2000	30/40	1,70
678	4535	3000/2725	30/40	2,80
693	4546	3550	40	2,70
698	4615	2430	40	1,40
697	4712	3250/2900	30/40	2,30
697	4712	3450/3075	30/40	2,60
773	5083	4250	40	2,00
780	4998	3875/3450	30/40	1,70
572	3585	925/825	30/40	2,40
587	3749	950	40	2,10



Alliance 324



Alliance FarmPRO 324



Alliance 347

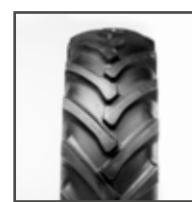

BKT AS 2001

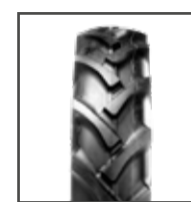

BKT TR 135









AS Reifen Diagonal

Preise und Bestände finden Sie unter www.bohnenkamp.de/shop

Artikel-Nr.	Größe	Last-/ Speed-Index	PR	TL/ TT	Profil	Marke	Felge ¹	Breite in mm	Außen ø in mm
15722520	9.5 - 32	110 A6/106 A8	6 PR	TT	TR 135	BKT	8/7	235	1255
15222692	12.4 - 32	125 A8	8 PR	TT	324	Alliance	11/10	315	1360
15722535	12.4 - 32	124 A6/121 A8	8 PR	TT	TR 135	BKT	11/9/10	325	1360
15722562	24.5 - 32	163 A6/159 A8	14 PR	TL	TR 137	BKT	21/20	622	1805
15722570	30.5 L - 32	162 A6/158 A8	12 PR	TL	TR 137	BKT	27	770	1865
15722572	30.5 L - 32	170 A6/167 A8	18 PR	TL	TR 137	BKT	27	770	1865
15222708	16.9 - 34	139 A8	8 PR	TT	FarmPRO 324	Alliance	15	430	1590
15222710	16.9 - 34	149 A8	14 PR	TT	324	Alliance	15/14	429	1585
15722600	16.9 - 34	139 A6/135 A8	8 PR	TT	TR 135	BKT	15/14	429	1585
15722602	16.9 - 34	142 A6/138 A8	10 PR	TT	TR 135	BKT	15/14	429	1585
15222730	18.4 - 34	153 A8	14 PR	TT	324	Alliance	16/15	467	1650
15222733	18.4 - 34	142 A8	8 PR	TT	FarmPRO 324	Alliance	16	467	1650
15722610	18.4 - 34	146 A6/143 A8	10 PR	TT	TR 135	BKT	16/15	467	1650
15722612	18.4 - 34	154 A6/150 A8	14 PR	TT	TR 135	BKT	16/15	467	1650
15722650	23.1 - 34	153 A6/149 A8	10 PR	TT	TR 135	BKT	20	585	1810
15722680	8.3 - 36	107 A6/104 A8	6 PR	TT	TR 135	BKT	7/6	211	1295
15222760	9.5 - 36	109 A8	6 PR	TT	324	Alliance	8/7	241	1353
15722683	9.5 - 36	122 A6/118 A8	10 PR	TT	TR 135	BKT	8/7	235	1360
15222771	12.4 - 36	126 A8	8 PR	TT	324	Alliance	11/10	315	1465
15222769	12.4 - 36	139 A8	14 PR	TT	FarmPRO 324	Alliance	11	315	1470
15722700	12.4 - 36	126 A6/123 A8	8 PR	TT	TR 135	BKT	11/9/10	325	1465
15222779	13.6 - 36	129 A8	8 PR	TT	FarmPRO 324	Alliance	12/11	345	1515
15722710	13.6 - 36	129 A6/125 A8	8 PR	TT	TR 135	BKT	12/11	345	1515
15222790	12.4 - 38	122 A8	6 PR	TT	304	Alliance	11/10	315	1515
15222792	12.4 - 38	135 A8	14 PR	TT	FarmPRO 324	Alliance	11	315	1514
15722750	12.4 - 38	127 A6/124 A8	8 PR	TT	TR 135	BKT	11/9/10	315	1525
15722755	12.4 - 38	138 A6/134 A8	14 PR	TT	TR 135	BKT	11/9/10	315	1525
15222794	13.6 - 38	131 A8	8 PR	TT	304	Alliance	12/11	345	1565
15722760	13.6 - 38	131 A6/127 A8	8 PR	TT	TR 135	BKT	12/11	345	1565
15222798	14.9 - 38	135 A8	8 PR	TT	304	Alliance	13/12	378	1615
15722765	15.5 - 38	133 A6/129 A8	8 PR	TT	TR 135	BKT	14	395	1585
15222784	15.5 - 38	133 A8	8 PR	TT	FarmPRO 324	Alliance	14	394	1569
15222802	16.9 - 38	141 A8	8 PR	TT	FarmPRO 324	Alliance	15	430	1689
15722770	16.9 - 38	141 A6/137 A8	8 PR	TT	TR 135	BKT	15/14	429	1685
15222810	18.4 - 38	155 A8	14 PR	TT	347	Alliance	16/15	467	1750
15222804	18.4 - 38	143 A8	8 PR	TT	FarmPRO 324	Alliance	16	467	1750
15722780	18.4 - 38	153 A6/149 A8	12 PR	TT	TR 135	BKT	16/15	467	1750
15222840	20.8 - 38	159 A8	14 PR	TT	347	Alliance	18	528	1840
15722790	20.8 - 38	156 A6/152 A8	12 PR	TT	TR 135	BKT	18/16	530	1835
15722795	9.5 - 42	125 A6/121 A8	10 PR	TT	TR 135	BKT	8/7	246	1510
15722825	20.8 - 42	168 A6/164 A8	18 PR	TL	TR 135	BKT	18/16	535	1950

¹ = empfohlene Felge / weitere zulässige Felgenbreiten

Alles auf einen Blick:

 statischer Halbmesser in mm	 Abrollumfang in mm	 Tragfähigkeit in kg	 km/h	 Luftdruck in bar
594	3686	1060/950	30/40	2,10
633	4090	1650	40	2,20
639	3998	1600/1450	30/40	2,30
807	5343	4875/4375	30/40	2,00
831	5520	4750/4250	30/40	1,40
831	5520	6000/5450	30/40	2,10
725	4720	2430	40	1,70
725	4716	3250	40	2,80
728	4794	2430/2180	30/40	1,70
728	4794	2650/2360	30/40	2,00
748	4882	3650	40	2,50
745	4882	2650	40	1,40
751	5009	3000/2725	30/40	1,80
751	5009	3750/3350	30/40	1,60/2,60
834	5321	3650/3250	30/40	1,40
628	4028	975/900	30/40	2,40
590	3906	1030	40	2,10
646	4000	1500/1320	30/40	3,50
682	4407	1700	40	2,30
687	4450	2430	40	4,10
696	4546	1700/1550	30/40	2,30
708	4632	1850	40	2,00
713	4454	1850/1650	30/40	2,00
710	4576	1500	40	1,70
714	4653	2180	40	3,90
718	4670	1750/1600	30/40	2,30
718	4670	2360/2120	30/40	3,70
729	4709	1950	40	2,00
735	4832	1950/1750	30/40	2,00
748	4843	2180	40	1,80
746	4660	2060/1850	30/40	1,80
737	4813	2060	40	1,80
770	5007	2575	40	1,70
788	4954	2575/2300	30/40	1,70
795	5185	3875	40	2,50
795	5190	2725	40	1,40
816	5145	3650/3250	30/40	2,30
826	5411	4375	40	2,30
852	5395	4000/3550	30/40	2,00
721	4663	1650/1450	30/40	3,50
909	5733	5600/5000	30/40	3,20

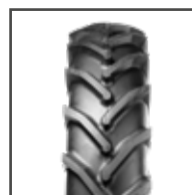

Alliance 304



Alliance 324



Alliance FarmPRO 324

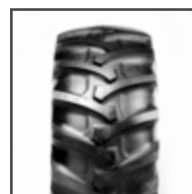

Alliance 347



BKT TR 135

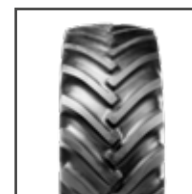

BKT TR 137



Industrie Traktorreifen

Preise und Bestände finden Sie unter www.bohnenkamp.de/shop

Artikel-Nr.	Größe	Last-/ Speed-Index	PR	TL/ TT	Profil	Marke	Felge ¹	Breite in mm	Außen ø in mm
15222212	14.9 - 24	145 A8	12 PR	TL	533	Alliance	13/12	378	1241
15772538	14.9 - 24	145 A8	12 PR	TT	AT 625	BKT	13/11/12	400	1265
15772555	14.9 - 24	145 A8	12 PR	TL	TR 459	BKT	13/11/12	390	1244
15222273	15.5/80 - 24	157 A6/154 A8	12 PR	TT	533	Alliance	12/13/14	394	1262
15712494	15.5/80 - 24	151 A6	16 PR	TL	Grip Star	BKT	12/13/14	392	1270
15222264	16.9 - 24	149 A8	12 PR	TL	533	Alliance	15	429	1309
15772560	16.9 - 24	149 A8	12 PR	TL	TR 459	BKT	15/14	440	1310
15772562	16.9 - 24	149 A8	12 PR	TL	TR 463	BKT	15/14	445	1300
15772568	16.9 - 24	149 A8	12 PR	TL	AT 621	BKT	15/14	450	1302
15772570	17.5L - 24	148 A6	12 PR	TL	TR 459	BKT	15/14	445	1270
15772575	18.4 - 24	155 A8	12 PR	TL	TR 459	BKT	16/15	472	1375
15772580	19.5L - 24	151 A8	12 PR	TL	TR 459	BKT	16	490	1333
15772585	19.5L - 24	151 A8	12 PR	TL	AT 621	BKT	16	482	1305
15772590	21 L - 24	155 A8	12 PR	TL	TR 459	BKT	18	533	1378
15772445	18.4 - 26	156 A8	12 PR	TL	TR 459	BKT	16/15	472	1425
15772595	18.4 - 26	156 A8	12 PR	TL	AT 621	BKT	16/15	480	1425
15722440	16.9 - 28	152 A8	12 PR	TL	TR 459	BKT	15/14	440	1410
15772539	16.9 - 28	152 A8	12 PR	TT	AT 625	BKT	15/14	450	1415
15772588	16.9 - 28	152 A8	12 PR	TL	TR 463	BKT	15/14	450	1405
15772593	16.9 - 30	153 A8	12 PR	TL	TR 459	BKT	15/14	440	1470
15772597	16.9 - 30	153 A8	12 PR	TL	AT 621	BKT	15/14	450	1460

¹ = empfohlene Felge / weitere zulässige Felgenbreiten

Alles auf einen Blick:

statischer Halbmesser in mm	Abrollumfang in mm	Tragfähigkeit in kg	km/h	Luftdruck in bar
560	3661	2900	40	2,90
575	3800	2900	40	2,90
562	3657	2900	40	2,90
552	3652	4125/3750	30/40	3,00
569	3683	3450	30	5,20
589	3855	3250	40	2,50
590	3850	3250	40	2,60
584	3877	3250	40	2,60
590	3906	3250	40	2,60
557	3825	3150	30	2,70
610	4114	3875	40	2,50
585	4031	3450	40	2,30
587	3936	3450	40	2,30
605	3995	3875	40	2,20
628	4346	4000	40	2,50
649	4288	4000	40	2,50
640	4145	3550	40	2,60
645	4254	3550	40	2,60
636	4190	3550	40	2,60
657	4484	3650	40	2,60
670	4398	3650	40	2,60



Alliance 533



BKT AT 621



BKT AT 625

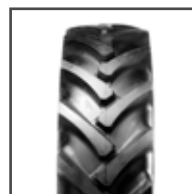

BKT Grip Star

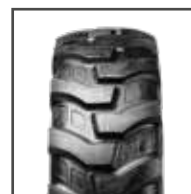

BKT TR 459

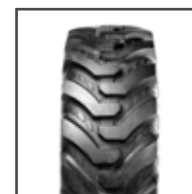

BKT TR 463







AS Reifen Radial

Preise und Bestände finden Sie unter www.bohnenkamp.de/shop

Artikel-Nr.	Größe	Last-/ Speed-Index	TL/ TT	Profil	Marke	Felge ¹	Breite in mm	Außen ø in mm
15227800	200/70 R 16	94 A8/94 B	TL	370	Alliance	6	197	686
15726540	200/70 R 16	94 A8/94 B	TL	Agrimax RT 765	BKT	6/7.0	197	686
15726543	220/70 R 16	99 A8/99 B	TL	Agrimax RT 765	BKT	7/8	221	715
10000148	240/70 R 16	104 D	TL	Agri Star II	Alliance	8/9	732	742
15726546	240/70 R 16	104 A8/104 B	TL	Agrimax RT 765	BKT	8/9	244	742
10927515	240/70 R 16	104 A8/104 B	TL	AC 70 T	Mitas	8/7/9	244	737
13626001	240/70 R 16	104 A8/104 B	TL	TM700	Trelleborg	8/9	244	742
10000280	240/70 R 16	104 D	TL	TRAXION 70	Vredestein	8/9	245	735
15726015	180/95 R 16	105 A8/105 B	TL	Agrimax RT 855	BKT	5.5/6.0	185	760
10000674	210/95 R 16	106 D	TL	Agri Star II	Alliance	7	214	806
10000188	210/95 R 16	116 A8	TL	Agrimax RT 855	BKT	7/5.50/6	214	806
15228003	260/70 R 16	109 D	TL	Agri Star II	Alliance	8/9	262	776
15726550	260/70 R 16	109 A8/109 B	TL	Agrimax RT 765	BKT	8/9	258	770
10000461	260/70 R 16	109 D/106 E	TL	VX-Tractor	Bridgestone	8/9	255	775
12426004	260/70 R 16	109 A8/106 B	TL	Fitker	Kleber	8/9	256	772
10927520	260/70 R 16	109 A8/109 B	TL	AC 70 T	Mitas	8/9	261	770
10001069	260/70 R 16	109 A8/109 B	TL	TM700	Trelleborg	8/9	258	770
10000278	260/70 R 16	109 D	TL	TRAXION 70	Vredestein	8/9	260	765
10927525	265/70 R 16	114 G	TL	AC 70 G MPT	Mitas	8/7/9	261	775
15228806	280/70 R 16	112 D	TL	Agri Star II	Alliance	8/9/10	285	804
15726560	280/70 R 16	112 A8/112 B	TL	Agrimax RT 765	BKT	9/8/10	282	798
10000462	280/70 R 16	112 D/109 E	TL	VX-Tractor	Bridgestone	9/8/10	276	813
10626010	7.50 R 16	102 A8/99 B	TL	R4000	Firestone	5.50/5.00/6.00	202	798
12426005	280/70 R 16	112 A8/109 B	TL	Fitker	Kleber	9/8/10	263	799
10927530	280/70 R 16	112 A8/112 B	TL	AC 70 T	Mitas	9/8/10	285	798
10001066	280/70 R 16	112 A8/112 B	TL	TM700	Trelleborg	9/8/10	282	798
10000277	280/70 R 16	112 D	TL	TRAXION 70	Vredestein	9/8/10	280	800
15225001	320/65 R 16	107 A8/107 B	TL	370	Alliance	10/9/11	325	835
15727030	320/65 R 16	120 A8/117 D	TL	Agrimax RT 657	BKT	10/9/11	319	822
10000475	320/65 R 16	117 D/114 E	TL	VX-Tractor	Bridgestone	9/8/10	305	830
13327510	320/65 R 16	107 D	TL	MultiBib	Michelin	8/9/10	300	827
10927540	320/65 R 16	120 A8/117 D	TL	AC 65	Mitas	10/9/11	316	844
13326810	11L R 16	122 A8	TL	XM 27	Michelin	8/10	291	850
14825700	320/65 R 16	117 D	TL	TRAXION 65	Vredestein	10/9/11	320	825
15235122	425/55 R 17	140 A8/140 B	TL	570	Alliance	13	425	890
15735210	425/55 R 17	134 G	TL	Multimax MP 513	BKT	13/13.00	421	900
10927500	425/55 R 17	134 G	TL	AC 70 G MPT	Mitas	13	428	884
14875000	440/50 R 17	135 D	TL	TRAXION VERSA	Vredestein	14/13	435	875
10000189	210/95 R 18	122 A8	TL	Agrimax RT 855	BKT	7/5.50/6	214	855
10001135	250/80 R 18	125 A8/125 B	TL	Agrimax RT 855	BKT	8/7/9	250	835

¹ = empfohlene Felge / weitere zulässige Felgenbreiten

Alles auf einen Blick:

 statischer Halbmesser in mm	 Abrollumfang in mm	 Tragfähigkeit in kg	 km/h	 Luftdruck in bar
315	2047	670	40/50	2,40
313	2037	670	40/50	2,40
324	2145	775	40/50	2,40
337	2298	900	65	2,40
335	2176	900	40/50	2,40
331	2192	900	40/50	2,40
340	2195	900	40/50	2,40
335	2190	900	65	2,40
340	2265	925	40/50	3,20
365	2381	950	65	2,40
350	2353	1250	40	2,40
358	2338	1030	65	2,40
346	2283	1030	40/50	2,40
353	2326	1030/950	65/70	2,40
346	2300	1030/950	40/50	2,40
345	2290	1030	40/50	2,40
340	2310	1030	40/50	2,40
345	2280	1030	65	2,40
354	2333	1180	90	3,50
371	2399	1120	65	2,40
356	2370	1120	40/50	2,40
366	2442	1120/1030	65/70	2,40
359	2421	850/775	40/50	3,20
358	2373	1120/1030	40/50	2,40
358	2390	1120	40/50	2,40
355	2385	1120	40/50	2,40
365	2390	1120	65	2,40
375	2456	975	40/50	1,60
366	2466	1400/1285	40/65	2,40
377	2493	1285/1180	65/70	2,40
368	2452	975	65	1,60
373	2497	1400/1285	40/65	2,40
375	2515	1500	40	2,40
370	2455	1285	65	2,40
400	2656	2500	40/50	3,50
399	2695	2120	90	3,50
399	2642	2120	90	3,50
405	2660	2180	65	3,60
378	2564	1500	40	2,80
375	2539	1650	40/50	4,00

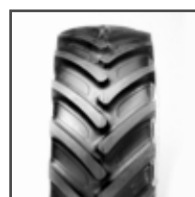

Alliance 370



Alliance 570

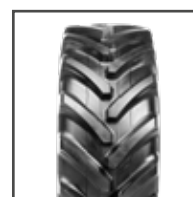

Alliance Agri Star II

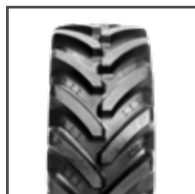

BKT Agrimax RT 657



BKT Agrimax RT 765

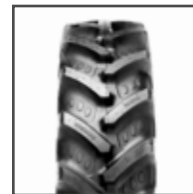

BKT Agrimax RT 855



BKT Multimax MP 513



Bridgestone VX-Tractor

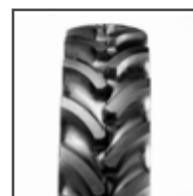

Firestone R4000



Kleber Fitker

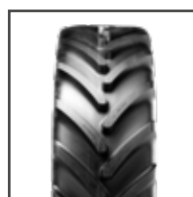

Michelin MultiBib



Michelin XM 27

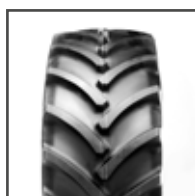

Mitas AC 65

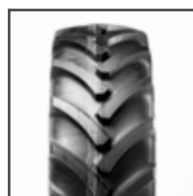

Mitas AC 70 G MPT

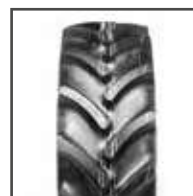

Mitas AC 70 T



Trelleborg TM700



Vredestein TRAXION 65



Vredestein TRAXION 70



Vredestein TRAXION VERSA







AS Reifen Radial

Preise und Bestände finden Sie unter www.bohnenkamp.de/shop

Artikel-Nr.	Größe	Last-/ Speed-Index	TL/ TT	Profil	Marke	Felge ¹	Breite in mm	Außen ø in mm
15228808	280/70 R 18	114 D	TL	Agri Star II	Alliance	9/8/10	285	855
15726566	280/70 R 18	114 A8/114 B	TL	Agrimax RT 765	BKT	9/8/10	282	849
12426006	280/70 R 18	114 A8/111 B	TL	Fitker	Kleber	9/10	276	857
10927545	280/70 R 18	114 A8/114 B	TL	AC 70 T	Mitas	9/8/10	280	852
10001033	280/70 R 18	114 A8/114 B	TL	TM700	Trelleborg	9/8/10	282	849
10000276	280/70 R 18	114 D	TL	TRAXION 70	Vredestein	9/8	275	850
15727035	320/65 R 18	109 A8/109 B	TL	Agrimax RT 657	BKT	10/9/11	319	873
13326823	320/65 R 18	109 A8/106 B	TL	XM 108	Michelin	9/10	309	875
14825720	320/65 R 18	119 D	TL	TRAXION 65	Vredestein	9/10/11	310	875
15727040	340/65 R 18	113 A8/113 B	TL	Agrimax RT 657	BKT	11/10/12	343	899
13327514	340/65 R 18	113 D	TL	MultiBib	Michelin	11/10	337	908
14825721	340/65 R 18	122 D	TL	TRAXION 65	Vredestein	9/10/11	320	905
10927550	325/70 R 18	125 G	TL	AC 70 G MPT	Mitas	10/9/11	321	918
10927555	365/70 R 18	132 G	TL	AC 70 G MPT	Mitas	11/10/12	365	978
12426024	7.50 R 20	104 A8	TL	Super Vigne	Kleber	5.50	200	904
10000149	260/70 R 20	113 D	TL	Agri Star II	Alliance	8/9	258	872
15726568	260/70 R 20	113 A8/113 B	TL	Agrimax RT 765	BKT	8/9	258	872
10000275	260/70 R 20	113 D	TL	TRAXION 70	Vredestein	8/9	265	880
15726040	210/90 R 20	110 A8/110 B	TL	Agrimax RT 855	BKT	7/6	211	890
15726042	210/95 R 20	110 A8/110 B	TL	Agrimax RT 855	BKT	7/6	214	908
15228812	280/70 R 20	116 D	TL	Agri Star II	Alliance	9/8/10	285	906
15726570	280/70 R 20	116 A8/116 B	TL	Agrimax RT 765	BKT	9/8/10	282	900
10927570	280/70 R 20	116 A8/116 B	TL	AC 70 T	Mitas	9/8/10	276	906
13626042	280/70 R 20	116 A8/116 B	TL	TM700	Trelleborg	9/10	279	910
10000273	280/70 R 20	116 D	TL	TRAXION 70	Vredestein	9/10	280	910
15726045	250/85 R 20	116 A8/116 B	TL	Agrimax RT 855	BKT	8/7/9	250	940
12426031	9.5 R 20	108 A8	TL	Super Vigne	Kleber	8/7	245	938
15228814	300/70 R 20	120 D	TL	Agri Star II	Alliance	9/10	300	956
15726580	300/70 R 20	120 A8/120 B	TL	Agrimax RT 765	BKT	9/10	295	952
12426065	300/70 R 20	120 A8/117 B	TL	Fitker	Kleber	9/8/10	292	947
10927585	300/70 R 20	110 A8/110 B	TL	AC 70 T	Mitas	9/10	290	942
10001064	300/70 R 20	110 A8/110 B	TL	TM700	Trelleborg	9/10	286	945
10000272	300/70 R 20	120 D	TL	TRAXION 70	Vredestein	9/10	295	945
10927565	275/80 R 20	131 G	TL	AC 70 G MPT	Mitas	9	274	966
15225020	340/65 R 20	124 A8/121 B	TL	370	Alliance	11/10/12	345	955
15727043	340/65 R 20	127 A8/124 D	TL	Agrimax RT 657	BKT	11/10/12	343	950
10000103	280/85 R 20	112 D	TL	Agri Star II	Alliance	10/9	292	984
15726050	280/85 R 20	112 A8/112 B	TL	Agrimax RT 855	BKT	10/9	292	984
10626085	280/85 R 20	112 D/109 E	TL	Performer 85	Firestone	10/9	297	978
10927560	280/85 R 20	112 A8/112 B	TL	AC 85	Mitas	10/9	299	981

¹ = empfohlene Felge / weitere zulässige Felgenbreiten

Alles auf einen Blick:

 statischer Halbmesser in mm	 Abrollumfang in mm	 Tragfähigkeit in kg	 km/h	 Luftdruck in bar
393	2581	1180	65	2,40
381	2547	1180	40/50	2,40
386	2556	1180/1090	40/50	2,40
383	2545	1180	40/50	2,40
380	2560	1180	40/50	2,40
385	2540	1180	65	2,40
392	2587	1030	40/50	1,60
389	2594	1030/950	40/50	1,60
390	2605	1360	65	2,40
400	2667	1150	40/50	1,60
399	2684	1150	65	1,60
415	2700	1500	65	2,40
421	2765	1650	90	3,50
449	2947	2000	90	3,50
409	2718	900	40	3,20
395	2588	1150	65	2,40
402	2639	1150	40/50	2,40
390	2620	1150	65	2,40
412	2681	1060	40/50	2,40
418	2749	1060	40/50	2,40
421	2731	1250	65	2,40
408	2705	1250	40/50	2,40
411	2725	1250	40/50	2,40
410	2745	1250	40/50	2,40
415	2715	1250	65	2,40
424	2812	1250	40/50	2,40
437	2811	1000	40	2,40
438	2868	1400	65	2,40
428	2854	1400	40/50	2,40
426	2814	1400/1285	40/50	2,40
428	2825	1060	40/50	1,60
429	2805	1060	40/50	1,60
439	2815	1400	65	2,40
446	2890	1950	90	4,50
431	2820	1600/1450	40/50	2,40
430	2892	1750/1600	40/65	2,40
449	2906	1120	65	1,60
441	2952	1120	40/50	1,60
442	2934	1120/1030	65/70	1,60
444	2934	1120	40/50	1,60

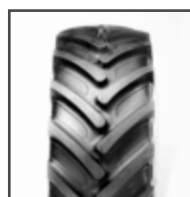

Alliance 370

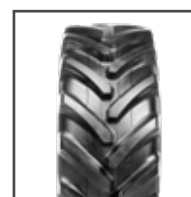

Alliance Agri Star II



BKT Agrimax RT 657

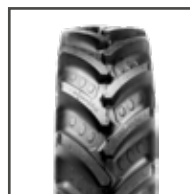

BKT Agrimax RT 765

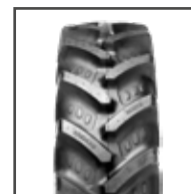

BKT Agrimax RT 855

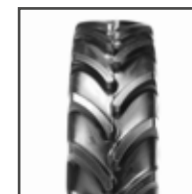

Firestone Performer 85



Kleber Fitker

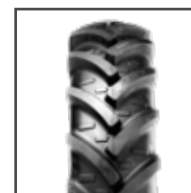

Kleber Super Vigne



Michelin MultiBib

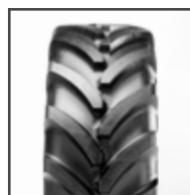

Michelin XM 108

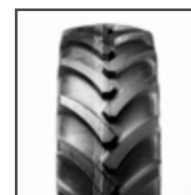

Mitas AC 70 G MPT



Mitas AC 70 T

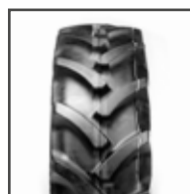

Mitas AC 85



Trelleborg TM700



Vredestein TRAXION 65

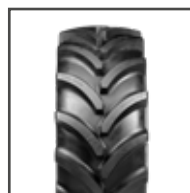

Vredestein TRAXION 70







AS Reifen Radial

Preise und Bestände finden Sie unter www.bohnenkamp.de/shop

Artikel-Nr.	Größe	Last-/ Speed-Index	TL/ TT	Profil	Marke	Felge ¹	Breite in mm	Außen ø in mm
13626045	280/85 R 20	112 A8/109 B	TL	TM600	Trelleborg	10/8/9	295	985
15726590	320/70 R 20	123 A8/123 B	TL	Agrimax RT 765	BKT	10/9/11	319	982
12426067	320/70 R 20	123 A8/120 B	TL	Fitker	Kleber	10/9/11	320	980
10927575	320/70 R 20	113 A8/113 B	TL	AC 70 T	Mitas	10/9/11	320	972
13626057	320/70 R 20	113 A8/113 B	TL	TM700	Trelleborg	10/9/11	318	975
10000286	320/70 R 20	123 D	TL	TRAXION 70	Vredestein	10/9	320	985
15228525	320/85 R 20	119 D	TL	Agri Star II	Alliance	11/9/10	333	1055
15726054	320/85 R 20	119 A8/119 B	TL	Agrimax RT 855	BKT	11/9/10	329	1052
12426077	320/85 R 20	119 A8/116 B	TL	Traker	Kleber	11/8/10	332	1047
10001065	320/85 R 20	119 A8/116 B	TL	TM600	Trelleborg	11/9/10	329	1052
15726600	360/70 R 20	129 A8/129 B	TL	Agrimax RT 765	BKT	11/10/12	357	1042
12426074	360/70 R 20	129 A8/126 B	TL	Fitker	Kleber	11/9/10/12	366	1052
10927595	360/70 R 20	120 A8/120 B	TL	AC 70 T	Mitas	11/10/12	360	1040
10001063	360/70 R 20	120 A8/120 B	TL	TM700	Trelleborg	11/10/12	352	1038
10000287	360/70 R 20	129 D	TL	TRAXION 70	Vredestein	11/10/12	360	1045
15226729	420/65 R 20	138 A8/135 D	TL	Agristar 365	Alliance	13/11/12	418	1054
15727044	420/65 R 20	138 A8/135 D	TL	Agrimax RT 657	BKT	13/11/12	418	1054
13326850	420/65 R 20	125 A8/125 B	TL	XM 108	Michelin	11/10/12	396	1064
10927610	420/65 R 20	128 A8/125 D	TL	AC 65	Mitas	13/11/12	415	1050
14825735	420/65 R 20	135 D	TL	TRAXION 65	Vredestein	13/11/12	415	1055
12426062	340/75 R 20	117 A8/114 B	TT	Super G	Kleber	11	333	1045
15227018	14.9 LR 20	119 A8/116 B	TL	387	Alliance	13	378	1075
15726060	14.9 LR 20	119 A8/119 B	TL	Agrimax RT 851	BKT	13/11/12/14	378	1100
12426058	14.9 LR 20	119 A8/116 B	TL	Super G	Kleber	13/11/12	390	1092
15228815	380/70 R 20	122 D	TL	Agri Star II	Alliance	12/11/13	382	1086
15726602	380/70 R 20	132 A8/132 B	TL	Agrimax RT 765	BKT	12/11/13	380	1082
10927600	380/70 R 20	122 A8/122 B	TL	AC 70 T	Mitas	12/11/13	383	1074
10001062	380/70 R 20	122 A8/122 B	TL	TM700	Trelleborg	12/11/13	370	1088
10000288	380/70 R 20	132 D	TL	TRAXION 70	Vredestein	12/11/13	390	1070
15727042	440/65 R 20	141 A8/138 D	TL	Agrimax RT 657	BKT	14/13/15	441	1080
13327520	440/65 R 20	128 D	TL	MultiBib	Michelin	14/13/15	441	1088
10927615	425/75 R 20	148 G	TL	AC 70 G MPT	Mitas	13/11	441	1148
10927620	445/65 R 22.5	160 G	TL	AC 70 +	Mitas	14/13	450	1172
15727410	210/90 R 24	107 A8/107 B	TL	Agrimax RT 955	BKT	7/6	214	1010
15226040	9.5 R 24	107 A8/104 B	TL	350	Alliance	8/7	241	1040
10000105	250/85 R 24	109 D	TL	Agri Star II	Alliance	8/7/9	248	1035
15726085	250/85 R 24	109 A8/109 B	TL	Agrimax RT 855	BKT	8/7/9	251	1036
10626106	250/85 R 24	109 D/106 E	TL	Performer 85	Firestone	8/7	245	1038
12426081	250/85 R 24	109 A8/106 B	TL	Traker	Kleber	8/7	248	1042

¹ = empfohlene Felge / weitere zulässige Felgenbreiten

Alles auf einen Blick:

 statischer Halbmesser in mm	 Abrollumfang in mm	 Tragfähigkeit in kg	 km/h	 Luftdruck in bar
450	2955	1120/1030	40/50	1,60
445	2938	1550	40/50	2,40
442	2917	1550/1400	40/50	2,40
441	2916	1150	40/50	1,60
439	2905	1150	40/50	1,60
450	2935	1550	65	2,40
480	3108	1360	65	1,60
467	3100	1360	40/50	1,60
466	3104	1360/1250	40/50	1,60
470	3160	1360/1250	40/50	1,60
469	3122	1850	40/50	2,40
466	3144	1850/1700	40/50	2,40
461	3083	1400	40/50	1,60
464	3100	1400	40/50	1,60
479	3115	1850	65	2,40
513	3110	2360/2180	40/65	2,50
468	3162	2360/2180	40/65	2,40
461	3135	1650	40/50	1,40
469	3146	1800/1650	40/65	1,60
480	3165	2180	65	2,40
470	3114	1285/1180	40/50	1,60
481	3156	1360/1250	40/50	1,60
498	3286	1360	40/50	1,60
491	3246	1360/1250	40/50	1,60
493	3252	1500	65	1,60
482	3213	2000	40/50	2,40
478	3195	1500	40/50	1,60
485	3240	1500	40/50	1,60
490	3190	2000	65	2,40
479	3240	2575/2360	40/65	2,40
474	3236	1800	65	1,60
521	3440	3150	90	4,00
536	3525	4500	90	6,00
462	3027	975	40/50	2,40
476	3096	975/900	40/50	1,60
500	3065	1030	65	1,60
475	3104	1030	40/50	1,60
465	3114	1030/950	65/70	1,60
472	3101	1030/950	40/50	1,60



Alliance 350

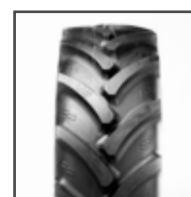

Alliance 387



Alliance Agri Star II

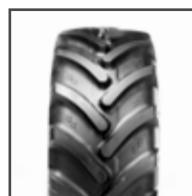

Alliance Agristar 365



BKT Agrimax RT 657

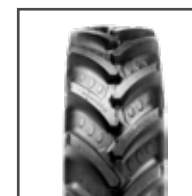

BKT Agrimax RT 765



BKT Agrimax RT 851

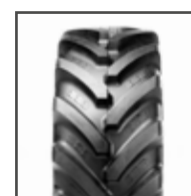

BKT Agrimax RT 955



Firestone Performer 85



Kleber Fitker



Kleber Super G



Kleber Traker

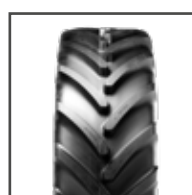

Michelin MultiBib



Michelin XM 108



Mitas AC 65

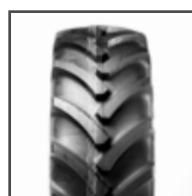

Mitas AC 70 G MPT



Mitas AC 70 T



Trelleborg TM600



Trelleborg TM700

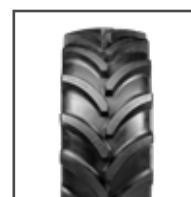

Vredestein TRAXION 70



Vredestein TRAXION 65







AS Reifen Radial

Preise und Bestände finden Sie unter www.bohnenkamp.de/shop

Artikel-Nr.	Größe	Last-/ Speed-Index	TL/ TT	Profil	Marke	Felge ¹	Breite in mm	Außen ø in mm
13626070	9.5 R 24	107 A8	TT	TM190	Trelleborg	8/7/9	245	1039
15228551	280/85 R 24	115 D	TL	Agri Star II	Alliance	10/9	302	1090
15726090	280/85 R 24	115 A8/115 B	TL	Agrimax RT 855	BKT	10/9	292	1086
10626114	280/85 R 24	115 D/112 E	TL	Performer 85	Firestone	10/9	292	1082
12426094	280/85 R 24	115 A8/112 B	TL	Traker	Kleber	10/9	288	1100
10927625	280/85 R 24	115 A8/115 B	TL	AC 85	Mitas	10/9	296	1090
10001061	280/85 R 24	115 A8/112 B	TL	TM600	Trelleborg	10/8/9	292	1086
14826332	280/85 R 24	115 A8/115 B	TL	TRAXION 85	Vredestein	10/9	295	1090
15228820	320/70 R 24	116 D	TL	Agri Star II	Alliance	10/9/11	322	1098
15726609	320/70 R 24	116 D	TL	Agrimax RT 765	BKT	10/9/11	319	1094
10626605	320/70 R 24	116 D/113 E	TL	Performer 70	Firestone	10/9	323	1102
12426098	320/70 R 24	116 A8/116 B	TL	Fitker	Kleber	10/9/11	332	1103
13327900	320/70 R 24	116 D	TL	OmniBib	Michelin	10/9/11	323	1101
10927640	320/70 R 24	116 A8/116 B	TL	AC 70 T	Mitas	10/9/11	320	1095
10927635	320/70 R 24	119 A8/116 D	TL	HC 70	Mitas	10/9/11	325	1115
10001060	320/70 R 24	116 A8/116 B	TL	TM700	Trelleborg	10/9/11	316	1099
10000294	320/70 R 24	116 D	TL	TRAXION 70	Vredestein	10/9/11	320	1100
15228561	320/85 R 24	122 D	TL	Agri Star II	Alliance	11/9/10	333	1156
15228562	320/85 R 24	142 D	TL	Agri Star II	Alliance	11/9/10	333	1156
15726100	320/85 R 24	122 A8/122 B	TL	Agrimax RT 855	BKT	11/9/10	329	1154
10000476	320/85 R 24	127 D/124 E	TL	VX-Tractor	Bridgestone	11/10	326	1148
10626126	320/85 R 24	122 D/119 E	TL	Performer 85	Firestone	11/9/10	324	1151
12426110	320/85 R 24	122 A8/119 B	TL	Traker	Kleber	11/10	324	1149
13326103	12.4 R 24	119 A8/116 B	TL	AgriBib	Michelin	11/10	324	1149
10927630	320/85 R 24	122 A8/122 B	TL	AC 85	Mitas	11/9/10	343	1158
10001059	320/85 R 24	122 A8/119 B	TL	TM600	Trelleborg	11/9/10	329	1154
14826334	320/85 R 24	122 A8/122 B	TL	TRAXION 85	Vredestein	11/9/10	335	1145
15228825	360/70 R 24	122 D	TL	Agri Star II	Alliance	11/10/12	360	1156
15726611	360/70 R 24	122 D	TL	Agrimax RT 765	BKT	11/10/12	357	1152
10000478	360/70 R 24	127 D/124 E	TL	VX-Tractor	Bridgestone	11/10/12	353	1154
10626615	360/70 R 24	122 D/119 E	TL	Performer 70	Firestone	11/10/12	360	1157
12426115	360/70 R 24	122 A8/122 B	TL	Fitker	Kleber	11/10/12	371	1153
13327905	360/70 R 24	122 D	TL	OmniBib	Michelin	11/10/12	373	1153
10927650	360/70 R 24	122 A8/122 B	TL	AC 70 T	Mitas	11/10/12	360	1150
10927660	360/70 R 24	125 A8/122 D	TL	HC 70	Mitas	11/10/12	365	1142
10001058	360/70 R 24	122 A8/122 B	TL	TM700	Trelleborg	11/10/12	352	1147
10000297	360/70 R 24	122 D	TL	TRAXION 70	Vredestein	11/10/12	360	1150
15226728	420/65 R 24	126 A8/126 B	TL	Agristar 365	Alliance	13	418	1156
15727046	420/65 R 24	141 A8/138 D	TL	Agrimax RT 657	BKT	13/11/12	418	1156
13327525	420/65 R 24	126 D	TL	MultiBib	Michelin	12/11	392	1156

¹ = empfohlene Felge / weitere zulässige Felgenbreiten

Alles auf einen Blick:

 statischer Halbmesser in mm	 Abrollumfang in mm	 Tragfähigkeit in kg	 km/h	 Luftdruck in bar
485	3140	975	40	1,60
502	3252	1215	65	1,60
492	3224	1215	40/50	1,60
487	3246	1215/1120	65/70	1,60
493	3267	1215/1120	40/50	1,60
497	3267	1215	40/50	1,60
494	3276	1215/1120	40/50	1,60
520	3275	1215	40/50	1,60
508	3236	1250	65	1,60
502	3245	1250	65	1,60
497	3306	1250/1150	65/70	1,60
496	3278	1250	40/50	1,60
497	3274	1250	65	1,60
505	3276	1250	40/50	1,60
491	3295	1360/1250	40/65	1,60
508	3300	1250	40/50	1,60
505	3245	1250	65	1,60
527	3462	1500	65	1,60
527	3462	2650	65	4,60
519	3424	1500	40/50	1,60
531	3438	1750/1600	65/70	2,40
512	3453	1500/1360	65/70	1,60
516	3413	1500/1360	40/50	1,60
520	3420	1360/1250	40/50	1,60
530	3484	1500	40/50	1,60
515	3465	1500/1360	40/50	1,60
540	3430	1500	40/50	1,60
525	3400	1500	65	1,60
519	3395	1500	65	1,60
530	3462	1750/1600	65/70	2,40
519	3471	1500/1360	65/70	1,60
517	3423	1500	40/50	1,60
513	3418	1500	65	1,60
516	3426	1500	40/50	1,60
508	3398	1650/1500	40/65	1,60
518	3425	1500	40/50	1,60
525	3395	1500	65	2,80
580	3415	1700	40/50	1,60
519	3468	2575/2360	40/65	2,40
508	3420	1700	65	1,60

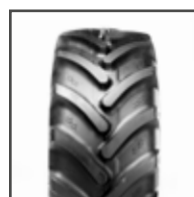

Alliance Agristar 365

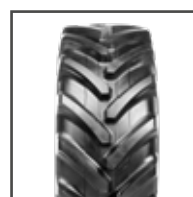

Alliance Agri Star II

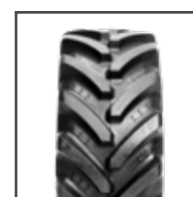

BKT Agrimax RT 657

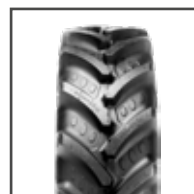

BKT Agrimax RT 765

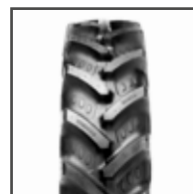

BKT Agrimax RT 855



Bridgestone VX-Tractor



Firestone Performer 70

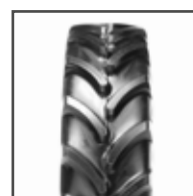

Firestone Performer 85



Kleber Fitker



Kleber Traker



Michelin AgriBib

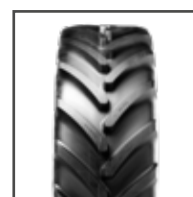

Michelin MultiBib



Michelin OmniBib

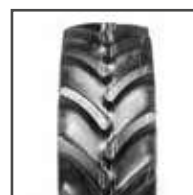

Mitas AC 70 T

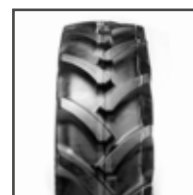

Mitas AC 85



Mitas HC 70

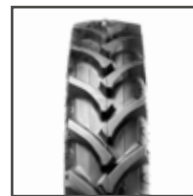

Trelleborg TM190



Trelleborg TM600



Trelleborg TM700



Vredestein TRAXION 70



Vredestein TRAXION 85



AS Reifen Radial

Preise und Bestände finden Sie unter www.bohnenkamp.de/shop



Artikel-Nr.	Größe	Last-/ Speed-Index	TL/TT	Profil	Marke	Felge ¹	Breite in mm	Außen ø in mm
15228571	340/85 R 24	125 D	TL	Agri Star II	Alliance	12/11	355	1192
15726110	340/85 R 24	125 A8/125 B	TL	Agrimax RT 855	BKT	12/11	353	1188
10000477	340/85 R 24	130 D/127 E	TL	VX-Tractor	Bridgestone	12/11	351	1187
10626134	340/85 R 24	125 D/122 E	TL	Performer 85	Firestone	12/11	355	1192
12426122	340/85 R 24	130 A8/127 B	TL	Traker	Kleber	12/11	359	1188
13326127	13.6 R 24	124 A8/121 B	TL	AgriBib	Michelin	12/11	370	1200
10927645	340/85 R 24	125 A8/125 B	TL	AC 85	Mitas	12/11	372	1189
10001057	340/85 R 24	125 A8/122 B	TL	TM600	Trelleborg	12/11	353	1188
14826340	340/85 R 24	125 A8/125 B	TL	TRAXION 85	Vredestein	12/11	360	1190
15228826	380/70 R 24	125 D	TL	Agri Star II	Alliance	12/11/13	385	1194
15726622	380/70 R 24	125 D	TL	Agrimax RT 765	BKT	12/11/13	380	1190
10001235	380/70 R 24	128 A8/125 D	TL	Agrimax Factor	BKT	12/11/13	380	1190
10000479	380/70 R 24	130 D/127 E	TL	VX-Tractor	Bridgestone	12/11/13	381	1191
10626625	380/70 R 24	125 D/122 E	TL	Performer 70	Firestone	12/11/13	395	1192
12426134	380/70 R 24	125 A8/125 B	TL	Fitker	Kleber	12/11/13	390	1204
13327910	380/70 R 24	125 D	TL	OmniBib	Michelin	12/11/13	399	1188
10927670	380/70 R 24	125 A8/125 B	TL	AC 70 G	Mitas	12/11/13	385	1190
10927655	380/70 R 24	125 A8/125 B	TL	AC 70 T	Mitas	12/11/13	387	1187
10927665	380/70 R 24	128 A8/125 D	TL	HC 70	Mitas	12/11/13	395	1191
10001056	380/70 R 24	125 A8/125 B	TL	TM700	Trelleborg	12/11/13	370	1193
10000291	380/70 R 24	125 D	TL	TRAXION 70	Vredestein	12/11/13	385	1185
10927675	405/70 R 24	149 G	TL	AC 70 G MPT	Mitas	13	419	1166
15226734	440/65 R 24	138 A8/135 D	TL	Agristar 365	Alliance	14/13	446	1187
15727045	440/65 R 24	138 A8/135 D	TL	Agrimax RT 657	BKT	14/13/15	441	1182
10000482	440/65 R 24	135 D/132 E	TL	VX-Tractor	Bridgestone	14/13/15	429	1181
10627102	440/65 R 24	128 D/125 E	TL	Maxi Traction 65	Firestone	14/13/15	439	1171
12427010	440/65 R 24	128 D	TL	Gripker	Kleber	14/13/15	440	1184
13327535	440/65 R 24	128 D	TL	MultiBib	Michelin	14/13/15	439	1187
10927680	440/65 R 24	131 A8/128 D	TL	AC 65	Mitas	14/12/13	445	1196
13626172	440/65 R 24	128 D	TL	TM800	Trelleborg	14/13/15	441	1182
14825745	440/65 R 24	128 D	TL	TRAXION 65	Vredestein	14/13/15	440	1185
13335201	445/70 R 24	151 G	TL	XM 47	Michelin	15/14	460	1242
10927705	445/70 R 24	151 G	TL	AC 70 G MPT	Mitas	13/12/14	425	1248
15228581	380/85 R 24	131 D	TL	Agri Star II	Alliance	12/11/13	385	1260
15726120	380/85 R 24	131 A8/131 B	TL	Agrimax RT 855	BKT	12/11/13	380	1256
10000480	380/85 R 24	137 D/134 E	TL	VX-Tractor	Bridgestone	13/11/12	399	1261
10626146	380/85 R 24	131 D/128 E	TL	Performer 85	Firestone	13/11/12	403	1257
12426140	380/85 R 24	131 A8/128 B	TL	Traker	Kleber	13/11/12	390	1252
10927685	380/85 R 24	131 A8/131 B	TL	AC 85	Mitas	12/11/13	402	1258
10001055	380/85 R 24	131 A8/128 B	TL	TM600	Trelleborg	13/11/12	390	1256

¹ = empfohlene Felge / weitere zulässige Felgenbreiten

Alles auf einen Blick:

statischer Halbmesser in mm	Abrollumfang in mm	Tragfähigkeit in kg	km/h	Luftdruck in bar
550	3481	1650	65	1,60
531	3540	1650	40/50	1,60
549	3555	1900/1750	65/70	2,40
537	3576	1650/1500	65/70	1,60
529	3529	1900/1750	40/50	1,60
551	3583	1600/1450	40/50	2,10
536	3552	1650	40/50	1,60
540	3547	1650/1500	40/50	1,60
550	3535	1650	40/50	1,60
548	3481	1650	65	1,60
538	3560	1650	65	1,60
538	3524	1800/1650	40/65	1,60
545	3575	1900/1750	65/70	2,40
535	3576	1650/1500	65/70	1,60
536	3569	1650	40/50	1,60
528	3520	1650	65	1,60
540	3524	1650	40/50	1,60
538	3508	1650	40/50	1,60
533	3545	1800/1650	40/65	1,60
538	3560	1650	40/50	1,60
540	3495	1650	65	1,60
541	3530	3250	90	4,50
547	3526	2360/2180	40/65	2,40
538	3546	2360/2180	40/65	2,40
524	3538	2180/2000	65/70	2,40
528	3513	1800/1650	65/70	1,60
525	3508	1800	65	1,60
529	3519	1800	65	1,60
543	3585	1950/1800	40/65	1,60
537	3545	1800	65	1,60
570	3600	1800	65	1,60
564	3705	3450	90	4,10
561	3708	3450	90	3,50
576	3668	1950	65	1,60
554	3720	1950	40/50	1,60
583	3776	2300/2120	65/70	2,40
564	3771	1950/1800	65/70	1,60
551	3703	1950/1800	40/50	1,60
563	3745	1950	40/50	1,60
560	3750	1950/1800	40/50	1,60

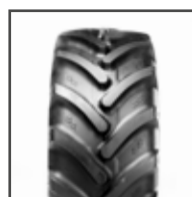

Alliance Agristar 365

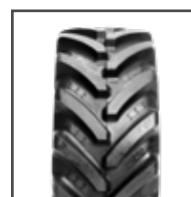

BKT Agrimax RT 657



BKT Agrimax RT 855



BKT Agrimax Factor



Bridgestone VX-Tractor



Firestone
Maxi Traction 65



Firestone
Performer 70



Kleber Fitker



Kleber Gripper

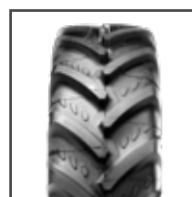

Kleber Traker

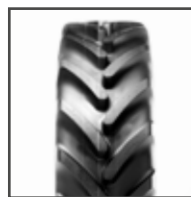

Michelin OmniBib

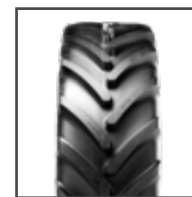

Michelin MultiBib

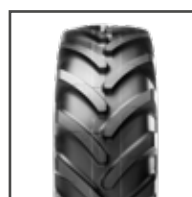

Michelin XM 47

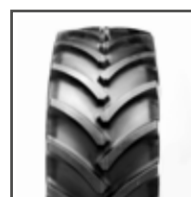

Mitas AC 65

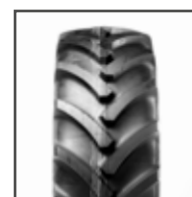

Mitas AC 70 G /
AC 70 G MPT

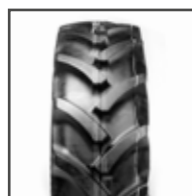

Mitas AC 85



Trelleborg TM600



Trelleborg TM700

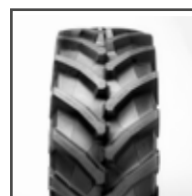

Trelleborg TM800



Vredestein
TRAXION 65



Vredestein
TRAXION 85



AS Reifen Radial





Preise und Bestände finden Sie unter www.bohnenkamp.de/shop

Artikel-Nr.	Größe	Last-/ Speed-Index	TL/ TT	Profil	Marke	Felge ¹	Breite in mm	Außen ø in mm
14826345	380/85 R 24	131 A8/131 B	TL	TRAXION 85	Vredestein	13/11/12	400	1240
15228828	420/70 R 24	130 D	TL	Agri Star II	Alliance	13/12/14	425	1250
15726628	420/70 R 24	134 D	TL	Agrimax RT 765	BKT	13/12/14	418	1248
10001234	420/70 R 24	137 A8/134 D	TL	Agrimax Factor	BKT	13/12/14	418	1248
10000481	420/70 R 24	136 D/133 E	TL	VX-Tractor	Bridgestone	13/12/14	417	1265
10626635	420/70 R 24	130 D/127 E	TL	Performer 70	Firestone	13/12/14	421	1246
12426152	420/70 R 24	136 A8/136 B	TL	Fitker	Kleber	13/12/14	437	1255
13327915	420/70 R 24	130 D	TL	OmniBib	Michelin	13/12/14	436	1251
10927690	420/70 R 24	130 A8/130 B	TL	AC 70 G	Mitas	13/12/14	435	1248
10927700	420/70 R 24	133 A8/130 D	TL	HC 70	Mitas	13/12/14	443	1245
10001054	420/70 R 24	130 A8/130 B	TL	TM700	Trelleborg	13/12/14	415	1253
10000298	420/70 R 24	130 D	TL	TRAXION 70	Vredestein	13/12/14	430	1240
15226732	480/65 R 24	140 D	TL	Agristar 365	Alliance	15	483	1238
15727050	480/65 R 24	143 A8/140 D	TL	Agrimax RT 657	BKT	15/14	479	1234
10000483	480/65 R 24	140 D/137 E	TL	VX-Tractor	Bridgestone	15/14	476	1246
10627112	480/65 R 24	133 D/130 E	TL	Maxi Traction 65	Firestone	15/14	473	1237
12427020	480/65 R 24	133 D	TL	Gripker	Kleber	15/14	483	1239
13327540	480/65 R 24	133 D	TL	MultiBib	Michelin	15/14	483	1240
10927730	480/65 R 24	136 A8/133 D	TL	AC 65	Mitas	15/14/13	473	1256
13626174	480/65 R 24	133 D	TL	TM800	Trelleborg	15/14/16	479	1234
15226012	460/70 R 24	159 A8/159 B	TL	570	Alliance	15/14	445	1245
15726641	460/70 R 24	159 A8/156 B	TL	Agro Industrial RT 747	BKT	15/14/16	465	1254
10927715	460/70 R 24	151 A8/163 A8*	TL	AC 70 G	Mitas	15/14/16	455	1236
15235235	495/70 R 24	155 G	TL	570	Alliance	16	499	1304
13335211	495/70 R 24	155 G	TL	XM 47	Michelin	16	506	1313
10927735	495/70 R 24	155 G	TL	AC 70 G MPT	Mitas	15/16/14	483	1313
15228594	420/85 R 24	137 D	TL	Agri Star II	Alliance	15/14/13	443	1328
15726130	420/85 R 24	137 A8/137 B	TL	Agrimax RT 855	BKT	15/14/13	450	1324
10626154	420/85 R 24	137 D/134 E	TL	Performer 85	Firestone	15/14	446	1323
12426167	420/85 R 24	142 A8/139 B	TL	Traker	Kleber	15/14	460	1329
13326168	16.9 R 24	134 A8/131 B	TL	AgriBib	Michelin	15/14	460	1330
10927710	420/85 R 24	137 A8/137 B	TL	AC 85	Mitas	15/14/13	475	1320
10001052	420/85 R 24	137 A8/134 B	TL	TM600	Trelleborg	15/14	438	1324
14826350	420/85 R 24	137 A8/137 B	TL	TRAXION 85	Vredestein	15/13/14	450	1320
15726651	480/70 R 24	138 D	TL	Agrimax RT 765	BKT	15/14/16	479	1316
10000484	480/70 R 24	143 D/140 E	TL	VX-Tractor	Bridgestone	15/14/16	482	1308
10626645	480/70 R 24	138 D/135 E	TL	Performer 70	Firestone	15/14/16	482	1323
12426157	480/70 R 24	138 A8/138 B	TL	Fitker	Kleber	15/14/16	494	1338
13327920	480/70 R 24	138 D	TL	OmniBib	Michelin	15/14/16	494	1327
10927720	480/70 R 24	138 A8/138 B	TL	AC 70 G	Mitas	15/16/14	483	1313
10927725	480/70 R 24	141 A8/138 D	TL	HC 70	Mitas	15/14/16	502	1320

* = höhere Tragfähigkeit für Einsatz auf gezogenen Fahrzeugen, niedrigere Tragfähigkeit für Einsatz auf angetriebenen Fahrzeugen

¹ = **empfohlene Felge** / weitere zulässige Felgenbreiten

Alles auf einen Blick:

 statischer Halbmesser in mm	 Abrollumfang in mm	 Tragfähigkeit in kg	 km/h	 Luftdruck in bar
580	3710	1950	40/50	1,60
560	3690	1900	65	1,60
554	3680	2120	65	2,00
		2300/2120	40/65	2,00
570	3820	2240/2060	65/70	2,40
560	3738	1900/1750	65/70	1,60
563	3727	2240	40/50	2,40
553	3702	1900	65	1,60
561	3708	1900	40/50	1,60
552	3695	2060/1900	40/65	1,60
562	3705	1900	40/50	1,60
560	3675	1900	65	1,60
555	3670	2500	65	2,00
562	3730	2725/2500	40/65	2,40
573	3736	2500/2300	65/70	2,40
557	3702	2060/1900	65/70	1,60
540	3655	2060	65	1,60
546	3667	2060	65	1,60
570	3764	2240/2060	40/65	1,60
536	3670	2060	65	1,60
564	3682	4375	40/50	4,00
556	3840	4375/4000	40/50	4,00
528	3620	3450/4875	40	3,20
588	3845	3875	90	4,00
587	3916	3875	90	4,10
582	3908	3875	90	3,50
605	3889	2300	65	1,60
582	3900	2300	40/50	1,60
595	3969	2300/2120	65/70	1,60
598	3949	2650/2430	40/50	2,40
586	3935	2120/1950	40/50	1,60
591	3930	2300	40/50	1,60
590	3970	2300/2120	40/50	1,60
620	3925	2300	40/50	1,60
580	3894	2360	65	1,60
600	3927	2725/2500	65/70	2,40
595	3969	2360/2180	65/70	1,60
589	3955	2360	40/50	1,60
578	3916	2360	65	1,60
582	3908	2360	40/50	1,60
574	3896	2575/2360	40/65	1,60



Alliance Agri Star II

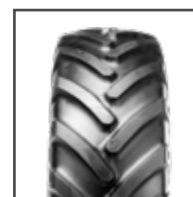

Alliance 570



BKT Agrimax RT 657

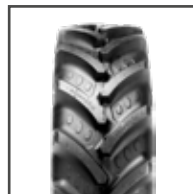

BKT Agrimax RT 765



BKT Agrimax RT 855



BKT Agrimax Factor



BKT Agro Industrial RT 747



Bridgestone VX-Tractor



Firestone Maxi Traction 65

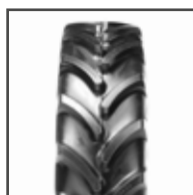

Firestone Performer 85



Kleber Gripker

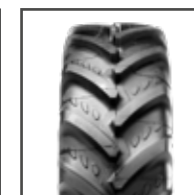

Kleber Traker

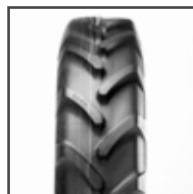

Michelin AgriBib



Michelin OmniBib

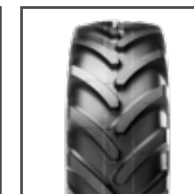

Michelin XM 47

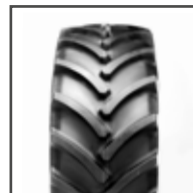

Mitas AC 65

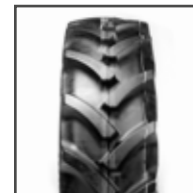

Mitas AC 85



Mitas HC 70



Trelleborg TM600



Trelleborg TM800

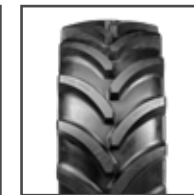

Vredestein TRAXION 70



AS Reifen Radial





Preise und Bestände finden Sie unter www.bohnenkamp.de/shop

Artikel-Nr.	Größe	Last-/ Speed-Index	TL/ TT	Profil	Marke	Felge ¹	Breite in mm	Außen ø in mm
10001053	480/70 R 24	138 A8/138 B	TL	TM700	Trelleborg	15/16/14	468	1300
10000281	480/70 R 24	138 D	TL	TRAXION 70	Vredestein	15/14	490	1305
15226733	540/65 R 24	146 D	TL	Agristar 365	Alliance	16	540	1312
15727060	540/65 R 24	149 A8/146 D	TL	Agrimax RT 657	BKT	16/18	530	1312
10000485	540/65 R 24	146 D/143 E	TL	VX-Tractor	Bridgestone	16/18	525	1308
10627123	540/65 R 24	140 D/137 E	TL	Maxi Traction 65	Firestone	16/18	525	1310
12427030	540/65 R 24	140 D	TL	Gripker	Kleber	16/18	532	1300
13327550	540/65 R 24	140 D	TL	MultiBib	Michelin	16/18	532	1312
10927750	540/65 R 24	143 A8/140 D	TL	AC 65	Mitas	16/18/15	523	1317
13626179	540/65 R 24	146 A8	TL	TM800	Trelleborg	16/15/18	535	1312
13626176	540/65 R 24	140 D	TL	TM800	Trelleborg	16/15/18	530	1312
14825755	540/65 R 24	140 D	TL	TRAXION 65	Vredestein	16/15/18	540	1315
15226020	19.5LR24	156 A8/153 B	TL	570	Alliance	16/15	495	1320
15726644	19.5LR24	157 A8/154 B	TL	Agro Industrial RT 747	BKT	16/15	485	1320
15727820	500/70 R 24	155 A8/167 A8	TL	RM 500	BKT	16/15	502	1310
10927746	500/70 R 24	155 A8/167 A8*	TL	AC 70 G	Mitas	16/15	496	1313
15727835	500/85 R 24	170 A8/182 A8*	TL	RM 500	BKT	16/15	520	1460
10000553	VF 500/85 R 24 CFO	163 A8	TL	VT Combine	Bridgestone	16	488	1446
10927740	500/85 R 24	158 A8/171 A8*	TL	SFT	Mitas	16/15	528	1458
15226774	1000/50 R 25	172 A8/166 D	TL	Agristar 375	Alliance	36.0	1065	1660
15227596	380/85 R 26	127 A8/127 B	TL	FarmPRO II	Alliance	12/11	380	1290
15227070	14.9 R 26	127 A8/124 B	TL	Power Drive 356	Alliance	13/12	378	1300
15227080	16.9 R 26	135 A8/132 B	TL	Power Drive 356	Alliance	15/14	429	1370
15227598	420/85 R 26	135 A8/135 B	TL	FarmPRO II	Alliance	15/14	429	1370
15726147	420/85 R 26	138 A8/138 B	TL	Agrimax RT 857	BKT	15/14/16	438	1374
10626190	420/85 R 26	138 A8/138 B	TL	RATFWD	Firestone	15/14	439	1384
13626192	480/70 R 26	139 A8/139 B	TL	TM700	Trelleborg	15/14/16	468	1358
13626211	540/65 R 26	141 D	TL	TM800	Trelleborg	16/15/18	540	1365
15227090	18.4 R 26	140 A8/137 B	TL	Power Drive 356	Alliance	16/15	476	1426
15227595	460/85 R 26	140 A8/140 B	TL	FarmPRO II	Alliance	15/16	465	1424
15726149	460/85 R 26	143 A8/143 B	TL	Agrimax RT 857	BKT	15/16	465	1442
10626195	18.4 R 26	140 A8/140 B	TL	RATFWD	Firestone	16/15	478	1450
15225089	VF 520/80 R 26 CFO	168 A8	TL	AgriFlex 372+	Alliance	16/18	505	1465
13327080	VF 520/80 R 26 CFO +	168 A8	TL	CerexBib 2	Michelin	16/18	503	1491
15225083	620/70 R 26	177 A8	TL	370	Alliance	20/18	625	1500
15225084	VF 620/70 R 26	170 D	TL	AgriFlex 372+	Alliance	21/20	626	1485
10000554	VF 620/70 R 26 CFO	172 A8	TL	VT Combine	Bridgestone	20		1575
13327082	VF 620/70 R 26 CFO+	173 A8	TL	CerexBib 2	Michelin	20	606	1513

* = höhere Tragfähigkeit für Einsatz auf gezogenen Fahrzeugen, niedrigere Tragfähigkeit für Einsatz auf angetriebenen Fahrzeugen

¹ = **empfohlene Felge** / weitere zulässige Felgenbreiten

Alles auf einen Blick:

 statischer Halbmesser in mm	 Abrollumfang in mm	 Tragfähigkeit in kg	 km/h	 Luftdruck in bar
580	3875	2360	40/50	1,60
585	3850	2360	65	1,60
592	3871	3000	65	2,40
590	3930	3250/3000	40/65	2,40
579	3920	3000/2725	65/70	2,40
592	3936	2500/2300	65/70	1,60
566	3835	2500	65	1,60
573	3873	2500	65	1,60
590	3922	2725/2500	40/65	1,60
595	3940	3000	40	2,60
595	3940	2500	65	1,60
620	3960	2500	65	1,60
600	3912	4000	40	3,00
585	3949	4125	40	3,00
572	3907	3875/5450	40	2,80
573	3908	3875/5450	40	2,80
622	4382	6000/8500	40	4,00
635	4311	4875	40	2,40
621	4237	4250/6150	40	2,80
753	5079	6300/5300	40/65	2,40
594	3800	1750	40/50	1,60
592	3857	1750/1600	40/50	1,60
624	4066	2180/2000	40/50	1,60
626	4072	2180	40/50	1,60
616	4115	2360	40/50	1,60
625	4089	2360	40/50	1,60
608	4060	2430	40/50	1,60
615	4060	2575	65	1,60
643	4205	2500/2300	40/50	1,60
638	4224	2500	40/50	1,60
642	4297	2725	40/50	1,60
650	4270	2500	40/50	1,60
627	4335	5600	40	2,80
649	4400	5600	40	2,80
662	4388	7300	40	4,00
644	4387	6000	65	2,40
683	4709	6300	40	2,40
655	4461	6500	40	2,80

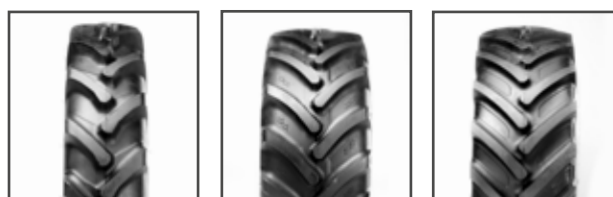

Alliance Power Drive 356 **Alliance Agristar 365** **Alliance 370**



Alliance Agriflex 372+ **Alliance Agristar 375** **Alliance 570**



Alliance FarmPRO II **BKT Agrimax RT 857** **BKT Agro Industrial RT 747**

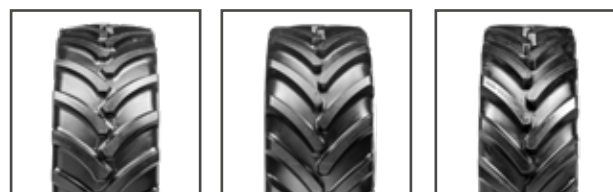

BKT RM 500 **Bridgestone VT Combine** **Bridgestone VX-Tractor**



Firestone RATFWD **Michelin CerexBib 2** **Michelin MultiBib**



Mitas AC 70 G **Mitas SFT** **Trelleborg TM700**



Trelleborg TM800 **Vredestein TRAXION 65** **Vredestein TRAXION 70**



AS Reifen Radial

Preise und Bestände finden Sie unter www.bohnenkamp.de/shop



Artikel-Nr.	Größe	Last-/ Speed-Index	TL/TT	Profil	Marke	Felge ¹	Breite in mm	Außen ø in mm
15226745	620/75 R 26	166 A8/166 B	TL	Agristar 375	Alliance	20/18	625	1595
15226744	620/75 R 26	167 A8/164 B	TL	360	Alliance	20	625	1590
15726660	620/75 R 26 CHO	166 A8/166 B	TL	Agrimax Teris	BKT	20	625	1590
15726658	620/75 R 26	167 A8/167 B	TL	Agrimax RT 600	BKT	20	625	1590
13326912	620/75 R 26	166 A8/166 B	TL	MegaXBib	Michelin	20/18	588	1602
13626214	620/75 R 26	166 A8	TL	TM2000	Trelleborg	20	633	1590
15226737	750/50 R 26	157 A8/151 D	TL	Multistar 376	Alliance	25/23	751	1420
15226739	750/65 R 26	173 A8/170 B	TL	360	Alliance	25/23/24	751	1623
15225088	VF 750/65 R 26	177 B	TL	Agriflex 372+	Alliance	25/27	754	1636
15727071	750/65 R 26 CHO	171 A8/171 B	TL	Agrimax Teris	BKT	25/23	764	1636
10000555	VF 750/65 R 26	177 A8	TL	VT Combine	Bridgestone	25	708	1628
13326922	750/65 R 26	171 A8/171 B	TL	MegaXBib	Michelin	25	732	1621
13327085	VF 750/65 R 26 CFO +	180 A8	TL	CerexBib 2	Michelin	25	748	1623
10926210	750/65 R 26	169 A8/166 D	TL	SFT	Mitas	25/23	738	1620
10001204	750/70 R 26	158 A8/158 B	TL	370	Alliance	24/25	750	1750
10001261	750/70 R 26	172 A8/172 B	TL	Agrimax RT 600	BKT	25/24	780	1750
15727420	210/95 R 28	116 A8/116 B	TL	Agrimax RT 955	BKT	7/6	214	1111
15226050	9.5 R 28	109 A8/106 B	TL	350	Alliance	8/7	241	1140
15726150	250/85 R 28	112 A8/112 B	TL	Agrimax RT 855	BKT	8/7/9	251	1137
10626226	250/85 R 28	112 D/109 E	TL	Performer 85	Firestone	8/7	247	1136
12426245	250/85 R 28	112 A8/109 B	TL	Traker	Kleber	8/7	247	1142
15227120	11.2 R 28	116 A8/113 B	TL	Power Drive 356	Alliance	10/9	284	1220
15228597	280/85 R 28	118 D	TL	Agri Star II	Alliance	10/9	302	1191
15726160	280/85 R 28	118 A8/118 B	TL	Agrimax RT 855	BKT	10/9	292	1187
10626236	280/85 R 28	118 D/115 E	TL	Performer 85	Firestone	10/9	293	1188
12426250	280/85 R 28	118 A8/115 B	TL	Traker	Kleber	10/9	297	1200
13328202	280/85 R 28	123 A8/120 D	TL	AgriBib 2	Michelin	10/9	299	1192
10927760	280/85 R 28	118 A8/118 B	TL	AC 85	Mitas	10/9	298	1190
10001032	280/85 R 28	118 A8/115 B	TL	TM600	Trelleborg	10/9	292	1187
14826365	280/85 R 28	118 A8/118 B	TL	TRAXION 85	Vredestein	10/9	285	1195
15227832	320/70 R 28	119 A8/119 B	TL	FarmPRO Radial 70	Alliance	10/11	319	1192
13626247	320/70 R 28	119 A8/119 B	TL	TM700	Trelleborg	10/9/11	316	1198
15228601	320/85 R 28	124 D	TL	Agri Star II	Alliance	11/9/10	333	1257
15726170	320/85 R 28	124 A8/124 B	TL	Agrimax RT 855	BKT	11/9/10	329	1255
10000491	320/85 R 28	129 D/126 E	TL	VX-Tractor	Bridgestone	11/10	323	1255
10626246	320/85 R 28	124 D/121 E	TL	Performer 85	Firestone	11/9/10	330	1257
12426265	320/85 R 28	124 A8/121 B	TL	Traker	Kleber	11/10	322	1253
10927765	320/85 R 28	124 A8/124 B	TL	AC 85	Mitas	11/9/10	329	1259
10001031	320/85 R 28	124 A8/121 B	TL	TM600	Trelleborg	11/9/10	329	1255

¹ = empfohlene Felge / weitere zulässige Felgenbreiten

Alles auf einen Blick:

statischer Halbmesser in mm	Abrollumfang in mm	Tragfähigkeit in kg	km/h	Luftdruck in bar
727	4816	5300	40/50	3,00
716	4685	5450/5000	40/50	3,20
730	4851	5300	40/50	3,20
730	4851	5450	40/50	3,20
712	4748	5300	40/50	3,20
716	4850	5300	40	3,20
642	4319	4125/3450	40/65	2,40
723	4817	6500/6000	40/50	3,00
698	4755	7300	50	3,00
713	4908	6150	40/50	3,20
701	4867	7300	40	2,40
730	4818	6150	40/50	3,20
701	4786	8000	40	2,80
720	4800	5800/5300	40/65	2,40
774	5177	4250	40/50	1,60
785	5269	6300	40/50	2,80
513	3333	1250	40/50	2,40
530	3418	1030/950	40/50	1,60
519	3421	1120	40/50	1,60
514	3408	1120/1030	65/70	1,60
520	3403	1120/1030	40/50	1,60
556	3599	1250/1150	40/50	1,60
553	3581	1320	65	1,60
545	3558	1320	40/50	1,60
535	3564	1320/1215	65/70	1,60
543	3571	1320/1215	40/50	1,60
545	3563	1550/1400	40/65	2,40
551	3582	1320	40/50	1,60
542	3580	1320/1215	40/50	1,60
545	3570	1320	40/50	1,60
547	3516	1360	40/50	1,60
552	3605	1360	40/50	1,60
502	3737	1600	65	1,60
569	3743	1600	40/50	1,60
579	3761	1850/1700	65/70	2,40
566	3771	1600/1450	65/70	1,60
562	3721	1600/1450	40/50	1,60
578	3793	1600	40/50	1,60
566	3796	1600/1450	40/50	1,60



Alliance 350

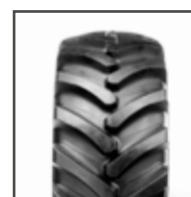

Alliance 360



Alliance 370



Alliance Agriflex 372+



Alliance Agristar 375



Alliance Multistar 376



Alliance FarmPRO Radial 70

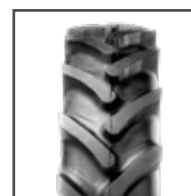

Alliance Power Drive 356

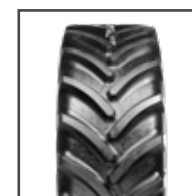

BKT Agrimax RT 600



BKT Agrimax RT 955

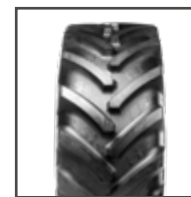

BKT Agrimax Teris

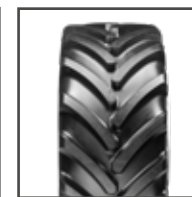

Bridgestone VT Combine



Firestone Performer 85



Kleber Traker

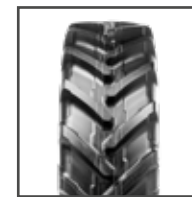

Michelin AgriBib 2



Michelin CerexBib 2



Michelin MegaXBib



Mitas SFT



Trelleborg TM600



Trelleborg TM2000



Vredestein TRAXION 85



AS Reifen Radial

Preise und Bestände finden Sie unter www.bohnenkamp.de/shop



Artikel-Nr.	Größe	Last-/ Speed-Index	TL/TT	Profil	Marke	Felge ¹	Breite in mm	Außen ø in mm
14826367	320/85 R 28	124 A8/124 B	TL	TRAXION 85	Vredestein	11/9/10	335	1250
10000104	360/70 R 28	125 D	TL	Agri Star II	Alliance	11/10/12	357	1251
15726699	360/70 R 28	125 D	TL	Agrimax RT 765	BKT	11/10/12	357	1251
10626665	360/70 R 28	125 D/122 E	TL	Performer 70	Firestone	11/10/12	360	1256
12426282	360/70 R 28	125 A8/125 B	TL	Fitker	Kleber	11/10/12	368	1263
13626267	360/70 R 28	125 A8/125 B	TL	TM700	Trelleborg	11/10/12	352	1246
15228611	340/85 R 28	127 D	TL	Agri Star II	Alliance	12/11	355	1293
15726180	340/85 R 28	127 A8/127 B	TL	Agrimax RT 855	BKT	12/11	353	1289
10000492	340/85 R 28	133 D/130 E	TL	VX-Tractor	Bridgestone	12/11	350	1298
10626256	340/85 R 28	127 D/124 E	TL	Performer 85	Firestone	12/11	354	1302
12426275	340/85 R 28	127 A8/124 B	TL	Traker	Kleber	12/11	363	1307
13326270	13.6 R 28	123 A8/120 B	TL	AgriBib	Michelin	12/11	345	1308
10927785	340/85 R 28	127 A8/127 B	TL	AC 85	Mitas	12/11	367	1299
10001051	340/85 R 28	127 A8/124 B	TL	TM600	Trelleborg	12/11	353	1289
14826368	340/85 R 28	127 A8/127 B	TL	TRAXION 85	Vredestein	12/11	360	1290
15228838	380/70 R 28	127 D	TL	Agri Star II	Alliance	12/11/13	385	1295
15726711	380/70 R 28	127 D	TL	Agrimax RT 765	BKT	12/11/13	380	1293
10000920	380/70 R 28	130 A8/127 D	TL	Agrimax Factor	BKT	12/11/13	380	1293
10000493	380/70 R 28	133 D/130 E	TL	VX-Tractor	Bridgestone	12/11/13	383	1294
10626675	380/70 R 28	127 D/124 E	TL	Performer 70	Firestone	12/11/13	387	1294
12426285	380/70 R 28	127 A8/127 B	TL	Fitker	Kleber	12/11/13	392	1308
13327930	380/70 R 28	127 D	TL	OmniBib	Michelin	12/11/13	390	1294
10927795	380/70 R 28	130 A8/127 D	TL	HC 70	Mitas	12/11/13	395	1292
10001050	380/70 R 28	127 A8/127 B	TL	TM700	Trelleborg	12/11/13	370	1292
10000292	380/70 R 28	127 D	TL	TRAXION 70	Vredestein	12/11/13	390	1290
10000689	420/65 R 28	135 D	TL	Agri Star II	Alliance	13/11/12	418	1257
15727083	420/65 R 28	138 A8/135 D	TL	Agrimax RT 657	BKT	13/11/12	418	1257
15226757	440/65 R 28	138 D	TL	Agristar 365	Alliance	14	441	1283
15727085	440/65 R 28	141 A8/138 D	TL	Agrimax RT 657	BKT	14/13/15	441	1283
10000497	440/65 R 28	138 D/135 E	TL	VX-Tractor	Bridgestone	14/13/15	425	1288
10627132	440/65 R 28	131 D/128 E	TL	Maxi Traction 65	Firestone	14/13/15	436	1277
12427040	440/65 R 28	131 D	TL	Gripker	Kleber	14/13/15	431	1297
13327600	440/65 R 28	131 D	TL	MultiBib	Michelin	14/13/15	437	1291
10927815	440/65 R 28	134 A8/131 D	TL	AC 65	Mitas	14/12/13	447	1292
13626273	440/65 R 28	131 D	TL	TM800	Trelleborg	14/13	441	1283
14825770	440/65 R 28	131 D	TL	TRAXION 65	Vredestein	14/13/15	440	1285
15727112	VF 480/60 R 28 NRO	145 D	TL	Agrimax V-Flecto	BKT	16	470	1290
13327800	VF 480/60 R 28	134 D	TL	XeoBib	Michelin	16	488	1298
15228621	380/85 R 28	133 D	TL	Agri Star II	Alliance	12/11/13	385	1360
15726190	380/85 R 28	133 A8/133 B	TL	Agrimax RT 855	BKT	12/11/13	380	1357

¹ = empfohlene Felge / weitere zulässige Felgenbreiten

Alles auf einen Blick:

statischer Halbmesser in mm	Abrollumfang in mm	Tragfähigkeit in kg	km/h	Luftdruck in bar
585	3725	1600	40/50	1,60
569	3716	1650	65	1,60
579	3767	1650	65	1,60
562	3768	1650/1500	65/70	1,60
565	3747	1650	40/50	1,60
568	3745	1650	40/50	1,60
594	3861	1750	65	1,60
588	3890	1750	40/50	1,60
598	3889	2060/1900	65/70	2,40
585	3906	1750/1600	65/70	1,60
586	3882	1750/1600	40/50	1,60
592	3893	1550/1400	40/50	1,60
587	3885	1750	40/50	1,60
595	3885	1750/1600	40/50	1,60
610	3870	1750	40/50	1,60
595	3796	1750	65	1,60
586	3883	1750	65	1,60
		1900/1750	40/65	1,60
592	3884	2060/1900	65/70	2,40
583	3882	1750/1600	65/70	1,60
594	3881	1750	40/50	1,60
580	3842	1750	65	1,60
576	3850	1900/1750	40/65	1,60
590	3895	1750	40/50	1,60
590	3825	1750	65	1,60
578	3770	2180	65	2,40
584	3824	2360/2180	40/65	2,40
590	3869	2360	65	2,40
590	3927	2575/2360	40/65	2,40
590	3890	2360/2180	65/70	2,40
583	3834	1950/1800	65/70	1,60
578	3847	1950	65	1,60
579	3833	1950	65	1,60
594	3896	2120/1950	40/65	1,60
583	3905	1950	65	1,60
615	3890	1950	65	1,60
571	3807	2900	65	1,60
567	3831	2120	65	1,00
622	4024	2060	65	1,60
606	4015	2060	40/50	1,60

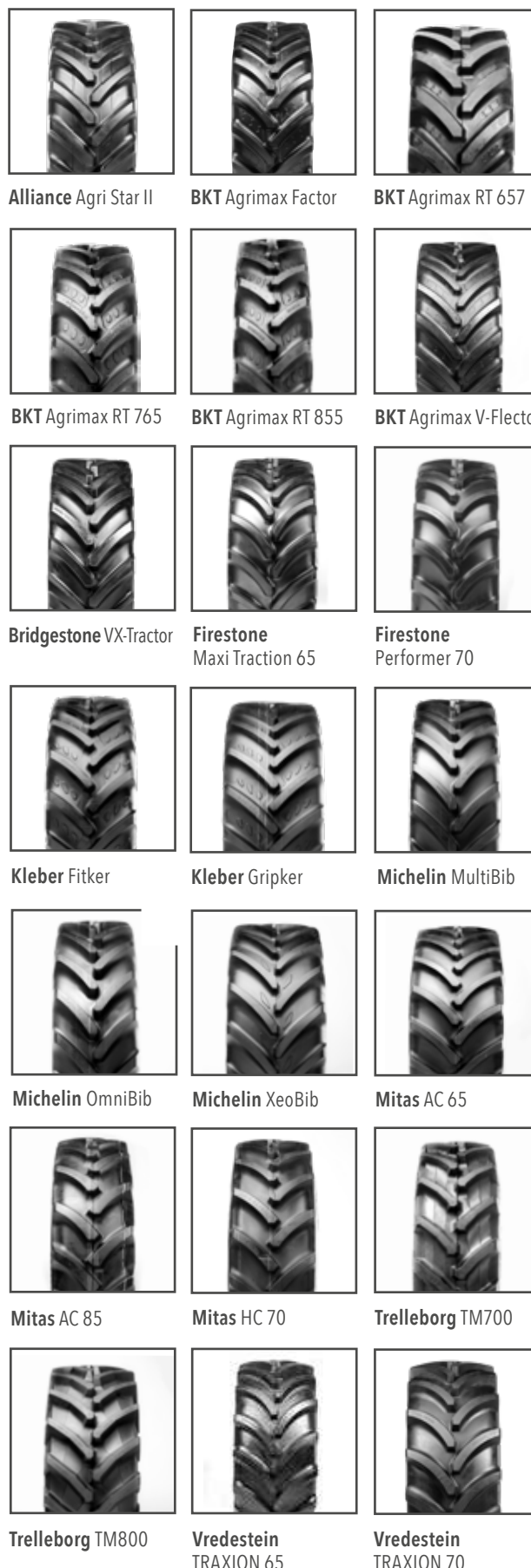



AS Reifen Radial

Preise und Bestände finden Sie unter www.bohnenkamp.de/shop



TL/
TT



Artikel-Nr.	Größe	Last-/ Speed-Index	TL/TT	Profil	Marke	Felge ¹	Breite in mm	Außen ø in mm
10000494	380/85 R 28	139 D/136 E	TL	VX-Tractor	Bridgestone	13/11/12	401	1361
10626266	380/85 R 28	133 D/130 E	TL	Performer 85	Firestone	13/11/12	403	1361
12426296	380/85 R 28	133 A8/130 B	TL	Traker	Kleber	13/11/12	391	1360
13326293	14.9 R 28	134 A8/131 B	TL	AgriBib	Michelin	13/12	393	1365
10927800	380/85 R 28	133 A8/133 B	TL	AC 85	Mitas	12/11/13	401	1362
10001049	380/85 R 28	133 A8/130 B	TL	TM600	Trelleborg	13/11/12	390	1357
14826370	380/85 R 28	133 A8/133 B	TL	TRAXION 85	Vredestein	13/11/12	400	1345
15228842	420/70 R 28	133 D	TL	Agri Star II	Alliance	13/12/14	425	1354
10000980	420/70 R 28	136 A8/133 D	TL	Agrimax Factor	BKT	13/12/14	418	1349
15726719	420/70 R 28	133 D	TL	Agrimax RT 765	BKT	13/12/14	418	1349
10000495	420/70 R 28	139 D/136 E	TL	VX-Tractor	Bridgestone	13/12/14	430	1356
10626685	420/70 R 28	133 D/130 E	TL	Performer 70	Firestone	13/12/14	423	1344
12426300	420/70 R 28	133 A8/133 B	TL	Fitker	Kleber	13/12/14	439	1366
13327935	420/70 R 28	133 D	TL	OmniBib	Michelin	13/12/14	436	1354
10927775	420/70 R 28	133 A8/133 B	TL	AC 70 G	Mitas	13/12/14	425	1348
10927780	420/70 R 28	136 A8/133 D	TL	HC 70	Mitas	13/12/14	438	1350
17427400	420/70 R 28	144 D/141 E	TL	Ground King	Nokian	13/12/14	420	1349
10001030	420/70 R 28	133 D	TL	TM700	Trelleborg	13/12/14	415	1354
10000300	420/70 R 28	133 D	TL	TRAXION 70	Vredestein	13/12	430	1345
10927805	440/70 R 28	152 A8/152 B	TL	AC 70 G	Mitas	13/14/15	435	1348
15225106	480/65 R 28	145 A8/142 D	TL	Agristar 365	Alliance	15/14	477	1335
15727090	480/65 R 28	145 A8/142 D	TL	Agrimax RT 657	BKT	15/14	479	1335
10000501	480/65 R 28	142 D/139 E	TL	VX-Tractor	Bridgestone	15/14	475	1344
10629020	VF 480/65 R 28	148 D/145 E	TL	VT Tractor	Bridgestone	16/15	470	1334
10627142	480/65 R 28	136 D/133 E	TL	Maxi Traction 65	Firestone	15/14	466	1333
12427050	480/65 R 28	136 D	TL	Gripker	Kleber	15/14	480	1339
13327605	480/65 R 28	136 D	TL	MultiBib	Michelin	15/14	476	1339
10927840	480/65 R 28	139 A8/136 D	TL	AC 65	Mitas	15/14/13	475	1355
17427402	480/65 R 28	148 D/145 E	TL	Ground King	Nokian	15/14	480	1348
13626305	480/65 R 28	136 D	TL	TM800	Trelleborg	15/14/16	479	1335
14825775	480/65 R 28	136 D	TL	TRAXION 65	Vredestein	15/14	485	1350
15727113	VF 520/60 R 28 NRO	149 D	TL	Agrimax V-Flecto	BKT	18	516	1335
13327810	VF 520/60 R 28	138 D	TL	XeoBib	Michelin	18	534	1338
13627410	VF 520/60 R 28	149 D	TL	TM1060	Trelleborg	18/16	520	1340
15228631	420/85 R 28	139 D	TL	Agri Star II	Alliance	15/13/14	443	1430
15726200	420/85 R 28	139 A8/139 B	TL	Agrimax RT 855	BKT	15/13/14	438	1425
10000496	420/85 R 28	144 D/141 E	TL	VX-Tractor	Bridgestone	15/14	459	1430
10626274	420/85 R 28	139 D/136 E	TL	Performer 85	Firestone	15/14	453	1430
12426321	420/85 R 28	144 A8/141 B	TL	Traker	Kleber	15/14	458	1435
13326312	16.9 R 28	141 A8/138 B	TL	AgriBib	Michelin	15/14	454	1435

¹ = empfohlene Felge / weitere zulässige Felgenbreiten

Alles auf einen Blick:

statischer Halbmesser in mm	Abrollumfang in mm	Tragfähigkeit in kg	km/h	Luftdruck in bar
627	4077	2430/2240	65/70	2,40
612	4083	2060/1900	65/70	1,60
607	4034	2060/1900	40/50	1,60
624	4072	2120/1950	40/50	2,40
608	4050	2060	40/50	1,60
615	4085	2060/1900	40/50	1,60
630	3985	2060	40/50	1,60
619	3974	2060	65	1,60
606	4000	2240/2060	40/65	1,60
604	4020	2060	65	1,60
621	4068	2430/2240	65/70	2,40
604	4032	2060/1900	65/70	1,60
608	4050	2060	40/50	1,60
602	4012	2060	65	1,60
604	4027	2060	40/50	1,60
610	4038	2240/2060	40/65	1,60
620	4102	2800/2575	65/70	3,20
608	4025	2060	65	1,60
615	3975	2060	65	1,60
604	4027	3550	40/50	3,20
607	3959	2900/2650	40/65	2,40
610	4091	2900/2650	40/65	2,40
616	4032	2650/2430	65/70	2,40
572	3947	3150/2900	65/70	1,60
601	3999	2240/2060	65/70	1,60
588	3958	2240	65	1,60
596	3970	2240	65	1,60
616	4064	2430/2240	40/65	1,60
617	4091	3150/2900	65/70	3,20
605	4025	2240	65	1,60
625	4020	2240	65	1,60
587	3910	3250	65	1,60
579	3942	2360	65	1,00
575	3985	3250	65	1,60
649	4230	2430	65	1,60
638	4241	2430	40/50	1,60
644	4319	2800/2575	65/70	2,40
640	4309	2430/2240	65/70	1,60
647	4267	2800/2575	40/50	2,40
655	4278	2575/2360	40/50	2,40



Alliance Agri Star II

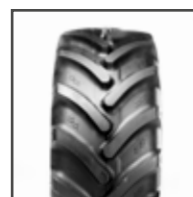

Alliance Agristar 365

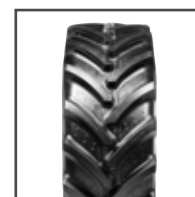

BKT Agrimax Factor



BKT Agrimax RT 765



BKT Agrimax V-Flecto



Bridgestone VT Tractor



Bridgestone VX-Tractor



Firestone Performer 85



Kleber Traker



Michelin AgriBib



Michelin OmniBib



Michelin XeoBib

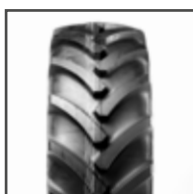

Mitas AC 70 G

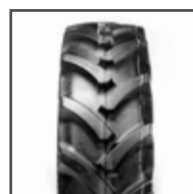

Mitas AC 85



Mitas HC 70



Nokian Ground King



Trelleborg TM600

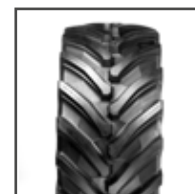

Trelleborg TM1060



Vredestein TRAXION 65



Vredestein TRAXION 70



Vredestein TRAXION 85



AS Reifen Radial

Preise und Bestände finden Sie unter www.bohnenkamp.de/shop



Artikel-Nr.	Größe	Last-/ Speed-Index	TL/TT	Profil	Marke	Felge ¹	Breite in mm	Außen ø in mm
10927810	420/85 R 28	139 A8/139 B	TL	AC 85	Mitas	15 /14/13	459	1431
10001048	420/85 R 28	139 A8/136 B	TL	TM600	Trelleborg	15 /14	438	1425
14826375	420/85 R 28	139 A8/139 B	TL	TRAXION 85	Vredestein	15 /13/14	455	1415
15225112	480/70 R 28	151 A8/145 E	TL	370	Alliance	15 /14/16	479	1423
15228846	480/70 R 28	140 D	TL	Agri Star II	Alliance	15 /14/16	482	1425
15228847	480/70 R 28	151 D	TL	Agri Star II	Alliance	15 /14/16	482	1425
15726741	480/70 R 28	140 D	TL	Agrimax RT 765	BKT	15 /14/16	479	1421
10000502	480/70 R 28	145 D/142 E	TL	VX-Tractor	Bridgestone	15 /14/16	487	1418
10626695	480/70 R 28	140 D/137 E	TL	Performer 70	Firestone	15 /14/16	481	1436
12426323	480/70 R 28	145 A8/145 B	TL	Fitker	Kleber	15 /14/16	486	1440
13327940	480/70 R 28	140 D	TL	OmniBib	Michelin	15 /14/16	500	1423
10927820	480/70 R 28	140 A8/140 B	TL	AC 70 T	Mitas	15 /14/16	480	1415
10927825	480/70 R 28	143 A8/140 D	TL	HC 70	Mitas	15 /14/16	498	1422
17427404	480/70 R 28	151 D/148 E	TL	Ground King	Nokian	15 /14/16	480	1421
10001047	480/70 R 28	140 D	TL	TM700	Trelleborg	15 /14/16	468	1415
10001029	480/70 R 28	148 A8/145 D	TL	TM700	Trelleborg	15 /14/16	468	1415
10000301	480/70 R 28	140 D	TL	TRAXION 70	Vredestein	15 /14	495	1405
15226748	540/65 R 28	152 A8/149 D	TL	Agristar 365	Alliance	16 /15/18	530	1420
15727105	540/65 R 28	145 A8/142 D	TL	Agrimax RT 600	BKT	16 /18	530	1413
15727100	540/65 R 28	152 A8/149 D	TL	Agrimax RT 657	BKT	16 /18	530	1413
15727106	VF 540/65 R 28	154 D	TL	Agrimax V-Flecto	BKT	20 /16/18	539	1413
10000503	540/65 R 28	149 D/146 E	TL	VX-Tractor	Bridgestone	16 /18	532	1419
10629030	VF 540/65 R 28 NRO	154 D/151 E	TL	VT Tractor	Bridgestone	18 /16	528	1404
10627152	540/65 R 28	142 D/139 E	TL	Maxi Traction 65	Firestone	16 /18	524	1410
12427060	540/65 R 28	142 D	TL	Gripker	Kleber	16 /18	535	1416
13327620	540/65 R 28	142 D	TL	MultiBib	Michelin	16 /18	529	1427
10927830	540/65 R 28	145 A8/142 D	TL	AC 65	Mitas	16 /15/18	530	1410
10927835	540/65 R 28	145 A8/142 D	TL	SFT	Mitas	16 /15/18	540	1414
17427408	540/65 R 28	154 D/151 E	TL	Ground King	Nokian	18 /16	540	1413
13626322	540/65 R 28	142 D	TL	TM800	Trelleborg	16 /15/18	530	1413
13626318	540/65 R 28	149 D/146 E	TL	TM800HS	Trelleborg	16 /15/18	530	1413
14825780	540/65 R 28	142 D	TL	TRAXION 65	Vredestein	16 /15/18	540	1410
10001391	VF 540/65 R 28 NRO	154 D	TL	TRAXION OPTIMALL	Vredestein	18 /16	545	1410
14826021	540/75 R 28	154 D	TL	TRAXION XXL	Vredestein	18 /16	565	1495
15225124	VF 600/60 R 28	146 D	TL	Agriflex 372+	Alliance	20	590	1430
15727114	VF 600/60 R 28 NRO	157 D	TL	Agrimax V-Flecto	BKT	20 /18	587	1440
13327820	VF 600/60 R 28	146 D	TL	XeoBib	Michelin	20	597	1429
13627420	VF 600/60 R 28	157 D	TL	TM1060	Trelleborg	20 /18/21	600	1420
10001392	VF 600/60 R 28 NRO	160 D	TL	TRAXION OPTIMALL	Vredestein	20 /18	605	1420
15727850	500/80 R 28	164 A8/176 A8*	TL	RM 500	BKT	16 /15	503	1495

* = höhere Tragfähigkeit für Einsatz auf gezogenen Fahrzeugen, niedrigere Tragfähigkeit für Einsatz auf angetriebenen Fahrzeugen

¹ = **empfohlene Felge** / weitere zulässige Felgenbreiten

Alles auf einen Blick:

statischer Halbmesser in mm	Abrollumfang in mm	Tragfähigkeit in kg	km/h	Luftdruck in bar
641	4262	2430	40/50	1,60
635	4290	2430/2240	40/50	1,60
660	4215	2430	40/50	1,60
640	4313	3450/2900	40/70	2,50
643	4211	2500	65	1,60
643	4211	3450	65	3,20
634	4185	2500	65	1,60
650	4254	2900/2650	65/70	2,40
647	4308	2500/2300	65/70	1,60
640	4267	2900	40/50	2,40
632	4217	2500	65	1,60
630	4206	2500	40/50	1,60
630	4220	2725/2500	40/65	1,60
642	4270	3450/3150	65/70	3,20
636	4190	2500	65	1,60
636	4240	3150/2900	40/65	2,40
635	4155	2500	65	1,60
640	4200	3550/3250	40/65	2,40
642	4202	2900/2650	40/65	1,60
643	4253	3550/3250	40/65	2,40
622	4160	3750	65	1,60
645	4259	3250/3000	65/70	2,40
606	4164	3750/3450	65/70	1,60
635	4224	2650/2430	65/70	1,60
617	4178	2650	65	1,60
630	4223	2650	65	1,60
624	4145	2900/2650	40/65	1,60
627	4210	2900/2650	40/65	1,60
637	4244	3750/3450	65/70	3,20
637	4240	2650	65	1,60
637	4220	3250/3000	65/70	2,40
660	4240	2650	65	1,60
620	4120	3750	65	2,00
685	4440	3750	65	2,40
620	4159	3000	65	1,00
632	4228	4125	65	1,60
610	4198	3000	65	1,00
605	4205	4125	65	1,60
605	4205	4500	65	2,00
635	4355	5000/7100	40	3,20

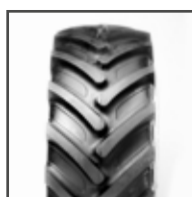

Alliance 370



Alliance Agriflex 372+

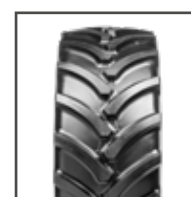

BKT RM 500

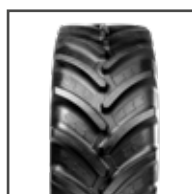

BKT Agrimax RT 600

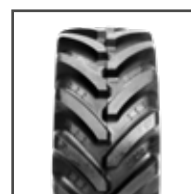

BKT Agrimax RT 657



Bridgestone VT Tractor

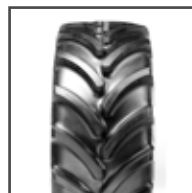

Firestone Maxi Traction 65

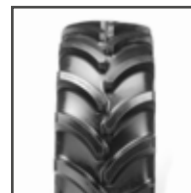

Firestone Performer 70



Kleber Fitker

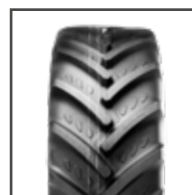

Kleber Gripker



Michelin XeoBib



Mitas AC 65

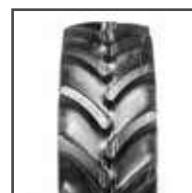

Mitas AC 70 T



Mitas SFT



Nokian Ground King



Trelleborg TM700

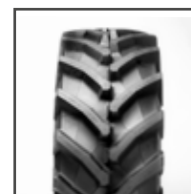

Trelleborg TM800 / TM800HS



Trelleborg TM1060



Vredestein TRAXION 85



Vredestein TRAXION OPTIMAL



Vredestein TRAXION XXL



AS Reifen Radial

Preise und Bestände finden Sie unter www.bohnenkamp.de/shop



Artikel-Nr.	Größe	Last-/ Speed-Index	TL/TT	Profil	Marke	Felge ¹	Breite in mm	Außen ø in mm
10927826	500/80 R 28	164 A8/176 A8*	TL	SFT	Mitas	16 /15	517	1495
15226753	600/65 R 28	157 A8/154 D	TL	Agristar 365	Alliance	20 /18	594	1484
15226758	VF 600/65 R 28 NRO	163 D	TL	Agristar VF 365	Alliance	20 /21	615	1491
15727840	600/65 R 28	156 A8/168 A8*	TL	RM 500	BKT	18 /16	590	1486
15727115	600/65 R 28	157 A8/154 D	TL	Agrimax RT 657	BKT	20 /18	611	1491
10000925	VF 650/65 R 28	163 D	TL	Agrimax V-Flecto	BKT	21 /20	597	1491
10000504	600/65 R 28	154 D/151 E	TL	VX-Tractor	Bridgestone	20 /18	617	1498
10629040	VF 600/65 R 28	159 D/156 E	TL	VT Tractor	Bridgestone	21 /20	602	1492
10627165	600/65 R 28	154 D/151 E	TL	Maxi Traction	Firestone	20 /18	617	1498
12426848	IF 600/65 R 28	160 D/156 E	TL	Topker	Kleber	21 /20	626	1486
13326867	600/65 R 28	154 D/150 E	TL	MachXBib	Michelin	20 /18/21	623	1502
10927845	600/65 R 28	150 A8/147 D	TL	AC 65	Mitas	18 /16	590	1485
10927850	600/65 R 28	157 A8/154 D	TL	SFT	Mitas	18 /20	606	1494
17427410	600/65 R 28	160 D/156 E	TL	Ground King	Nokian	20 /18	600	1507
13626326	600/65 R 28	147 D	TL	TM800	Trelleborg	18 /20	590	1491
13626328	600/65 R 28	154 D/151 E	TL	TM800HS	Trelleborg	18 /20	590	1491
14826030	600/65 R 28	147 D	TL	TRAXION XXL	Vredestein	18 /20	610	1480
14826040	600/65 R 28	154 D	TL	TRAXION XXL	Vredestein	18 /20	610	1480
10001390	VF 600/65 R 28 NRO	163 D	TL	TRAXION OPTIMALL	Vredestein	21 /20	615	1490
15727110	IF 710/55 R 28 CFO	165 D	TL	Agrimax Force	BKT	25	716	1493
15225126	VF 600/70 R 28 CFO	173 D	TL	Agriflex 372+	Alliance	21 /20	625	1560
15228850	600/70 R 28	161 D	TL	Agri Star II	Alliance	20 /18	614	1555
15727116	600/70 R 28	157 D	TL	Agrimax RT 765	BKT	18 /20	591	1551
10001233	600/70 R 28	160 A8/157 D	TL	Agrimax Factor	BKT	20 /18	611	1551
15727117	IF 600/70 R 28	164 D	TL	Agrimax Force	BKT	21 /20	603	1551
10000505	600/70 R 28	157 D/154 E	TL	VX-Tractor	Bridgestone	20 /18	630	1557
10626698	600/70 R 28	157 D/154 E	TL	Maxi Traction	Firestone	20 /18	630	1557
13326869	600/70 R 28	157 D/154 E	TL	MachXBib	Michelin	20 /18/21	629	1571
10927855	600/70 R 28	160 A8/157 D	TL	SFT	Mitas	18 /20	627	1574
17427411	600/70 R 28	164 D/160 E	TL	Ground King	Nokian	20 /18	610	1562
13626333	600/70 R 28	157 D/154 E	TL	TM900HP	Trelleborg	18 /20	604	1551
14826045	600/70 R 28	157 D	TL	TRAXION XXL	Vredestein	20 /18	610	1540
15727118	420/65 R 30	139 A8/136 D	TL	Agrimax RT 657	BKT	13 /11/12	418	1308
15228640	380/85 R 30	135 D	TL	Agri Star II	Alliance	12 /11/13	385	1410
15226060	VF 380/85 R 30	146 D	TL	Agriflex 354 +	Alliance	13 /12	394	1412
15726235	380/85 R 30	135 A8/135 B	TL	Agrimax RT 855	BKT	12 /11/13	380	1408
10000506	380/85 R 30	140 D/137 E	TL	VX-Tractor	Bridgestone	13 /11/12	399	1413
10626285	380/85 R 30	135 D/132 E	TL	Performer 85	Firestone	13 /11/12	406	1405
12426336	380/85 R 30	135 A8/132 B	TL	Traker	Kleber	13 /12	396	1413
13328205	380/85 R 30	140 A8/140 B	TL	AgriBib 2	Michelin	12 /13	380	1408

* = höhere Tragfähigkeit für Einsatz auf gezogenen Fahrzeugen, niedrigere Tragfähigkeit für Einsatz auf angetriebenen Fahrzeugen

¹ = **empfohlene Felge** / weitere zulässige Felgenbreiten

Alles auf einen Blick:

statischer Halbmesser in mm	Abrollumfang in mm	Tragfähigkeit in kg	km/h	Luftdruck in bar
635	4355	5000/7100	40	3,20
669	4450	4125/3750	40/65	2,40
642	4436	4875	65	2,00
640	4340	4000/5600	40	2,00
670	4470	4125/3750	40/65	2,40
		4875	65	2,00
670	4518	3750/3450	65/70	2,40
638	4406	4375/4000	65/70	1,60
670	4518	3750/3450	65/70	2,40
661	4417	4500/4000	65/70	2,40
666	4465	3750/3350	65/70	2,40
661	4411	3350/3075	40/65	1,60
664	4444	4125/3750	40/65	2,40
682	4564	4500/4000	65/70	3,20
660	4447	3075	65	1,60
660	4490	3750/3450	65/70	2,40
670	4405	3075	65	1,60
670	4400	3750	65	2,40
645	4410	4875	65	2,00
663	4442	5150	65	2,40
681	4602	6500	65	2,80
708	4652	4625	65	2,80
696	4692	4125	65	2,40
714	4667	4500/4125	40/65	2,40
694	4654	5000	65	2,40
704	4672	4125/3750	65/70	2,40
704	4672	4125/3750	65/70	2,40
703	4666	4125/3750	65/70	2,40
696	4660	4500/4125	40/65	2,40
708	4756	5000/4500	65/70	3,20
699	4720	4125/3750	65/70	2,40
700	4590	4125	65	2,40
606	3952	2430/2240	40/65	2,40
642	4208	2180	65	1,60
625	4163	3000	65	1,60
633	4190	2180	40/50	1,60
653	4229	2500/2300	65/70	2,40
634	4215	2180/2000	65/70	1,60
628	4188	2180/2000	40/50	1,60
636	4188	2500	40/50	2,40



Alliance Agriflex 354+



Alliance Agriflex 372+

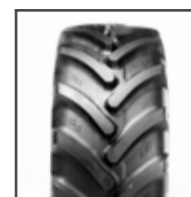

Alliance Agristar 365 / Agristar VF 365



BKT Agrimax Factor



BKT Agrimax Force

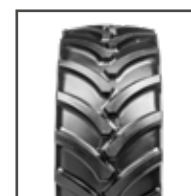

BKT RM 500

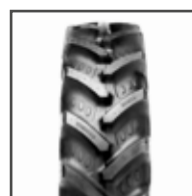

BKT Agrimax RT 855



Bridgestone VT Tractor

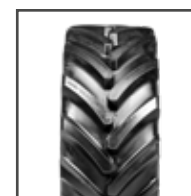

Bridgestone VX-Tractor

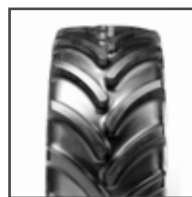

Firestone Maxi Traction



Firestone Performer 85



Kleber Topker



Kleber Traker



Michelin AgriBib 2



Michelin MachXBib



Mitas SFT



Nokian Ground King

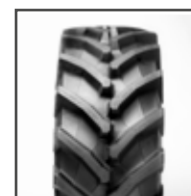

Trelleborg TM800 / TM800HS

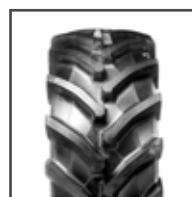

Trelleborg TM900HP



Vredestein TRAXION OPTIMALL



Vredestein TRAXION XXL



AS Reifen Radial

Preise und Bestände finden Sie unter www.bohnenkamp.de/shop



TL/
TT



Artikel-Nr.	Größe	Last-/ Speed-Index	TL/TT	Profil	Marke	Felge ¹	Breite in mm	Außen ø in mm
10927860	380/85 R 30	135 A8/135 B	TL	AC 85	Mitas	12/11/13	398	1427
13626335	380/85 R 30	135 A8/135 B	TL	TM600	Trelleborg	13/11/12	390	1408
14826380	380/85 R 30	135 A8/135 B	TL	Traxion 85 II	Vredestein	12/11/13	390	1410
15228860	420/70 R 30	134 D	TL	Agri Star II	Alliance	13/12/14	425	1402
15726777	420/70 R 30	134 D	TL	Agrimax RT 765	BKT	13/12/14	418	1398
12426356	420/70 R 30	134 A8/131 B	TL	Fitker	Kleber	13/12/14	410	1399
10927865	420/70 R 30	137 A8/134 D	TL	HC 70	Mitas	13/12/14	433	1392
13626346	420/70 R 30	134 A8/134 B	TL	TM700	Trelleborg	13/12/14	415	1400
15227185	16.9 R 30	137 A8/134 B	TL	387	Alliance	15	429	1475
15228651	420/85 R 30	140 D	TL	Agri Star II	Alliance	15/13/14	443	1476
15726240	420/85 R 30	140 A8/140 B	TL	Agrimax RT 855	BKT	15/13/14	438	1475
10000507	420/85 R 30	145 D/142 E	TL	VX-Tractor	Bridgestone	15/14	447	1469
10626296	420/85 R 30	140 D/137 E	TL	Performer 85	Firestone	15/14	446	1475
12426353	16.9 R 30	137 A8/134 B	TL	Super G	Kleber	15/14	439	1470
12426340	420/85 R 30	140 A8/137 B	TL	Traker	Kleber	15/14	447	1474
13326331	16.9 R 30	137 A8/134 B	TL	AgriBib	Michelin	15/14	447	1480
10927875	420/85 R 30	140 A8/140 B	TL	AC 85	Mitas	15/13/14	472	1478
13626350	420/85 R 30	140 A8/137 B	TL	TM600	Trelleborg	15/14	438	1475
14826385	420/85 R 30	140 A8/140 B	TL	TRAXION 85	Vredestein	15/13/14	455	1470
10000152	420/90 R 30	147 D	TL	Agri Star II	Alliance	13/14	418	1518
15727425	420/90 R 30	147 A8/147 B	TL	Agrimax RT 945	BKT	13/14	418	1518
13328208	420/90 R 30	147 A8/147 B	TL	AgriBib 2	Michelin	13/14	418	1518
15228864	480/70 R 30	141 D	TL	Agri Star II	Alliance	15/14/16	482	1480
15225140	480/70 R 30	150 A8/144 E	TL	370	Alliance	15/14/16	479	1474
15228865	480/70 R 30	156 D	TL	Agri Star II	Alliance	15/14/16	482	1480
15726781	480/70 R 30	141 D	TL	Agrimax RT 765	BKT	15/14/16	479	1478
10000509	480/70 R 30	147 D/144 E	TL	VX-Tractor	Bridgestone	15/14/16	490	1481
10626705	480/70 R 30	141 D/138 E	TL	Performer 70	Firestone	15/14/16	486	1489
12426355	480/70 R 30	141 A8/141 B	TL	Fitker	Kleber	15/14/16	495	1483
13327945	480/70 R 30	141 D	TL	OmniBib	Michelin	15/14/16	498	1482
10927885	480/70 R 30	141 A8/141 B	TL	AC 70 G	Mitas	15/14/16	485	1462
10927890	480/70 R 30	141 A8/141 B	TL	AC 70 T	Mitas	15/14/16	496	1477
10927880	480/70 R 30	144 A8/141 D	TL	HC 70	Mitas	15/14/16	499	1474
13626357	480/70 R 30	141 D	TL	TM700	Trelleborg	15/14/16	468	1474
13626358	480/70 R 30	147 D/144 E	TL	TM700HS	Trelleborg	15/16/14	468	1474
10000290	480/70 R 30	141 D	TL	TRAXION 70	Vredestein	15/14/16	490	1470
15226771	540/65 R 30	153 A8/150 D	TL	Agristar 365	Alliance	16/18	560	1486
15226763	540/65 R 30	168 A8	TL	360	Alliance	16/18	560	1486
10001570	VF 540/65 R 30	161 D	TL	Agriflex 372+	Alliance	20/18	549	1464
15727120	540/65 R 30	153 A8/150 D	TL	Agrimax RT 657	BKT	16/18/15	530	1464
15727119	540/65 R 30	150 D/147 E	TL	Agrimax Sirio	BKT	16/18	530	1464

¹ = empfohlene Felge / weitere zulässige Felgenbreiten

Alles auf einen Blick:

statischer Halbmesser in mm	Abrollumfang in mm	Tragfähigkeit in kg	km/h	Luftdruck in bar
641	4255	2180	40/50	1,60
635	4238	2180	40/50	1,60
645	4150	2180	40/50	1,60
638	4163	2120	65	1,60
631	4172	2120	65	1,60
628	4217	2120/1950	40/50	1,60
622	4150	2300/2120	40/65	1,60
636	4204	2120	40/50	1,60
667	4357	2300/2120	40/50	1,60
675	4431	2500	65	1,60
661	4421	2500	40/50	1,60
679	4400	2900/2650	65/70	2,40
666	4425	2500/2300	65/70	1,60
657	4362	2300/2120	40/50	1,60
657	4371	2500/2300	40/50	1,60
664	4395	2300/2120	40/50	1,60
666	4414	2500	40/50	1,60
660	4455	2500/2300	40/50	1,60
685	4425	2500	40/50	1,60
686	4468	3075	65	2,40
684	4571	3075	40/50	2,40
684	4513	3075	40/50	2,40
663	4412	2575	65	1,60
674	4491	3350/2800	40/70	2,40
663	4412	4000	65	3,80
659	4372	2575	65	1,60
678	4442	3075/2800	65/70	2,40
670	4467	2575/2360	65/70	1,60
662	4400	2575	40/50	1,60
656	4388	2575	65	1,60
653	4345	2575	40/50	1,60
667	4435	2575	40/50	1,60
655	4380	2800/2575	40/65	1,60
667	4425	2575	65	1,60
667	4430	3075/2800	65/70	2,40
665	4370	2575	65	1,60
668	4483	3650/3350	40/65	2,40
670	4421	5600	40	2,40
659	4346	4625	65	2,40
670	4403	3650/3350	40/65	2,40
669	4400	3350/3075	65/70	2,40

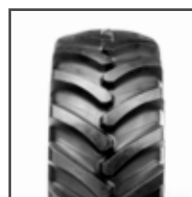

Alliance 360

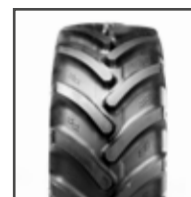

Alliance Agristar 365

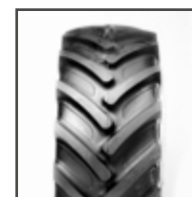

Alliance 370

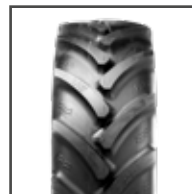

Alliance 387

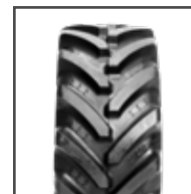

BKT Agrimax RT 657



BKT Agrimax RT 765

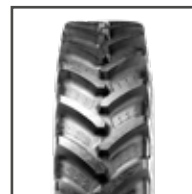

BKT Agrimax RT 945



BKT Agrimax Sirio

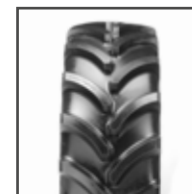

Firestone Performer 70



Kleber Fitker



Kleber Super G



Michelin AgriBib



Michelin AxioBib 2



Michelin OmniBib

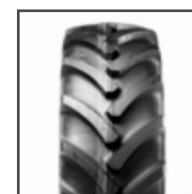

Mitas AC 70 G



Mitas AC 70 T

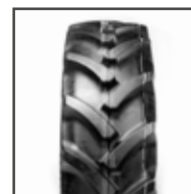

Mitas AC 85



Trelleborg TM600



Trelleborg TM700 / TM700HS



Vredestein TRAXION 70



Vredestein TRAXION 85 / Traxion 85 II



AS Reifen Radial

Preise und Bestände finden Sie unter www.bohnenkamp.de/shop

Artikel-Nr.	Größe	Last-/ Speed-Index	TL/ TT	Profil	Marke	Felge ¹	Breite in mm	Außen ø in mm
15727745	VF 540/65 R 30	158 D	TL	Agrimax V-Flecto	BKT	20/18	539	1464
10000556	VF 540/65 R 30	161 A8	TL	VT Combine	Bridgestone	18	510	1455
10000510	540/65 R 30	150 D/147 E	TL	VX-Tractor	Bridgestone	16/18	530	1474
10629058	VF 540/65 R 30 NRO	155 D/152 E	TL	VT Tractor	Bridgestone	18/16	528	1464
10627175	540/65 R 30	143 D/140 E	TL	Maxi Traction 65	Firestone	16/18	521	1462
12427070	540/65 R 30	143 D	TL	Gripker	Kleber	16/18	527	1460
13327630	540/65 R 30	143 D	TL	MultiBib	Michelin	16/18	527	1472
13326930	VF 540/65 R 30	158 D/155 E	TL	AxioBib 2	Michelin	18/16	545	1468
10927900	540/65 R 30	153 A8/150 D	TL	AC 65	Mitas	16/15/18	526	1485
10928220	540/65 R 30	153 A8/150 D	TL	SFT	Mitas	16/15/18	548	1487
10927902	VF 540/65 R 30	155 D	TL	HC 2000	Mitas	20/18	570	1455
17427412	540/65 R 30	155 D/152 E	TL	Ground King	Nokian	18/16	540	1464
13626353	540/65 R 30	143 D	TL	TM800	Trelleborg	16/15/18	530	1464
13626354	540/65 R 30	150 D/147 E	TL	TM800	Trelleborg	16/15/18	530	1464
10000986	VF 540/65 R 30	158 D/155 E	TL	TM1000PT	Trelleborg	18/16	540	1480
14825790	540/65 R 30	143 D	TL	TRAXION 65	Vredestein	16/15/18	540	1460
14825791	540/65 R 30	150 D	TL	TRAXION 65	Vredestein	16/15/18	540	1460
10001389	VF 540/65 R 30 NRO	158 D	TL	TRAXION OPTIMALL	Vredestein	18/16	45	1480
15225144	VF 600/60 R 30	147 D	TL	Agriflex 372+	Alliance	20	590	1490
15727126	VF 600/60 R 30 NRO	158 D	TL	Agrimax V-Flecto	BKT	20/18/21	595	1485
13327830	VF 600/60 R 30	147 D	TL	XeoBib	Michelin	20	603	1493
13328070	VF 600/60 R 30	162 D/159 E	TL	AxioBib 2	Michelin	20/18	597	1468
13627430	VF 600/60 R 30	158 D	TL	TM1060	Trelleborg	20/18	595	1490
10001388	VF 600/60 R 30 NRO	162 D	TL	TRAXION OPTIMALL	Vredestein	20/18	600	1480
15228661	460/85 R 30	145 D	TL	Agri Star II	Alliance	16/14/15	480	1544
15726245	460/85 R 30	145 A8/145 B	TL	Agrimax RT 855	BKT	16/14/15	475	1544
10000508	460/85 R 30	150 D/147 E	TL	VX-Tractor	Bridgestone	16/15	482	1542
10626306	460/85 R 30	145 D/142 E	TL	Performer 85	Firestone	16/15	484	1535
12426359	460/85 R 30	145 A8/142 B	TL	Traker	Kleber	16/15	478	1547
13326344	18.4 R 30	142 A8/139 B	TL	AgriBib	Michelin	16/15	504	1550
10927905	460/85 R 30	145 A8/145 B	TL	AC 85	Mitas	16/14/15	516	1546
13626371	460/85 R 30	145 A8/142 B	TL	TM600	Trelleborg	16/15	475	1544
14826387	460/85 R 30	145 A8/145 B	TL	TRAXION 85	Vredestein	15/13/14	490	1545
15228870	520/70 R 30	145 D	TL	Agri Star II	Alliance	16/15/18	516	1536
13626376	520/70 R 30	145 A8/145 B	TL	TM700	Trelleborg	16/15/18	520	1535
13626378	520/70 R 30	151 D/148 E	TL	TM700HS	Trelleborg	16/15/18	520	1535
15727123	600/65 R 30	158 A8/155 D	TL	Agrimax RT 657	BKT	20/18	611	1542
10627176	600/65 R 30	155 D/152 E	TL	Maxi Traction	Firestone	20/18	614	1549
10927915	600/65 R 30	152 A8/149 D	TL	AC 65	Mitas	18/16	590	1549

¹ = empfohlene Felge / weitere zulässige Felgenbreiten

Alles auf einen Blick:

statischer Halbmesser in mm	Abrollumfang in mm	Tragfähigkeit in kg	km/h	Luftdruck in bar
650	4351	4250	65	1,60
640	4333	4625	40	2,40
668	4422	3350/3075	65/70	2,40
630	4337	3875/3550	65/70	1,60
659	4386	2725/2500	65/70	1,60
642	4317	2725	65	1,60
648	4353	2725	65	1,60
645	4339	4250/3875	65/70	2,00
664	4419	3650/3350	40/65	2,40
668	4435	3650/3350	40/65	2,40
650	4340	3875	65	1,60
672	4481	3875/3550	65/70	3,20
665	4400	2725	65	1,60
665	4445	3350/3075	65/70	2,40
635	4450	4250/3875	65/70	2,00
670	4400	2725	65	1,60
670	4400	3350	65	2,40
650	4360	4250	65	2,00
651	4335	3075	65	1,00
649	4404	4250	65	1,60
633	4379	3075	65	1,00
643	4336	4750/4375	65/70	2,00
625	4420	4250	65	1,60
655	4390	4750	65	2,00
697	4575	2900	65	1,60
680	4562	2900	40/50	1,60
711		3350/3075	65/70	2,40
690	4605	2900/2650	65/70	1,60
681	4574	2900/2650	40/50	1,60
695	4602	2650/2430	40/50	1,60
697	4618	2900	40/50	1,60
691	4678	2900/2650	40/50	1,60
725	4605	2900	40/50	1,60
688	4496	2900	65	1,60
680	4590	2900	40/50	1,60
680	4615	3450/3150	65/70	2,40
697	4609	4250/3875	40/65	2,40
700	4647	3875/3550	65/70	2,40
687	4591	3550/3250	40/65	1,60

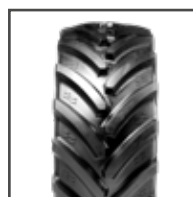

Alliance
Agriflex 372+



Alliance Agri Star II



BKT Agrimax RT 855

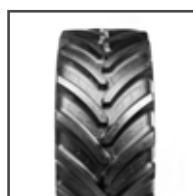

BKT Agrimax V-Flecto

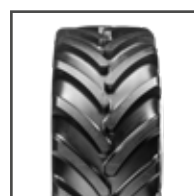

Bridgestone
VT Combine



Bridgestone
VX-Tractor

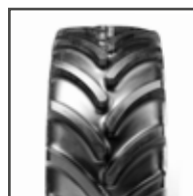

Firestone
Maxi Traction



Firestone
Maxi Traction 65



Kleber Gripker



Michelin AxioBib 2

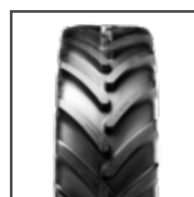

Michelin MultiBib



Michelin XeoBib

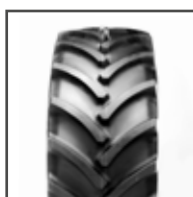

Mitas AC 65

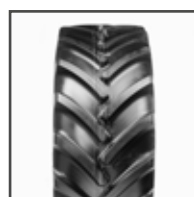

Mitas HC 2000



Mitas SFT



Nokian Ground King

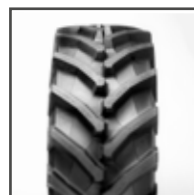

Trelleborg TM800



Trelleborg TM1000PT



Trelleborg TM1060



Vredestein
TRAXION 65



Vredestein
TRAXION OPTIMALL



AS Reifen Radial

Preise und Bestände finden Sie unter www.bohnenkamp.de/shop



Artikel-Nr.	Größe	Last-/ Speed-Index	TL/TT	Profil	Marke	Felge ¹	Breite in mm	Außen ø in mm
15225159	710/55 R 30	153 D	TL	Agristar 378 XL	Alliance	23	677	1516
15727133	IF 710/55 R 30 CFO	166 D	TL	Agrimax Force	BKT	25	716	1544
10000546	VF 710/55 R 30 NRO	165 D/161 E	TL	VT Tractor	Bridgestone	25/23	718	1544
13326865	710/55 R 30	153 D	TL	MachXBib	Michelin	23	678	1518
10927925	710/55 R 30	162 A8/159 D	TL	SFT	Mitas	23	690	1500
10001395	VF 710/55 R 30 NRO	165 D	TL	TRAXION OPTIMALL	Vredestein	25/23	715	1530
15727860	500/85 R 30	164 A8/176 A8*	TL	RM 500	BKT	16/15	535	1610
10927895	500/85 R 30	164 A8/176 A8*	TL	SFT	Mitas	16/15	517	1605
15228875	600/70 R 30	152 D	TL	Agri Star II	Alliance	20/18	614	1605
15225147	VF 600/70 R 30	170 D	TL	Agriflex 372+	Alliance	21/20	625	1600
10000687	600/70 R 30	155 A8/152 D	TL	Agrimax Factor	BKT	20/18	611	1602
15726784	600/70 R 30	152 D	TL	Agrimax RT 765	BKT	20/18	591	1602
15726790	600/70 R 30	161 A8/158 D	TL	Agrimax Fortis	BKT	20/18	611	1602
15726787	IF 600/70 R 30 CFO	165 D	TL	Agrimax Force	BKT	21/20	603	1602
15726786	IF 600/70 R 30	165 D/162 E	TL	Agrimax Sirio	BKT	21/20	603	1602
15726788	VF 600/70 R 30 NRO	168 D	TL	Agrimax V-Flecto	BKT	21/20	603	1602
10000511	600/70 R 30	158 D/155 E	TL	VX-Tractor	Bridgestone	20/18	618	1622
10629061	VF 600/70 R 30 NRO	165 D/161 E	TL	VT Tractor	Bridgestone	21/20/18	613	1607
10626725	600/70 R 30	158 D/155 E	TL	Maxi Traction	Firestone	20/18	618	1622
13326057	600/70 R 30	158 D	TL	MachXBib	Michelin	20/18/21	638	1604
13328073	VF 600/70 R 30	168 D/165 E	TL	AxioBib 2	Michelin	21/20	632	1579
10927920	600/70 R 30	155 A8/152 D	TL	SFT	Mitas	18/20	625	1595
17427416	600/70 R 30	165 D/161 E	TL	Ground King	Nokian	20/18	600	1588
13626388	600/70 R 30	158 D/155 E	TL	TM900HP	Trelleborg	18/20	605	1608
10000028	VF 600/70 R 30	170 D/167 E	TL	TM1000PT	Trelleborg	21/20	615	1600
14826055	600/70 R 30	158 D	TL	TRAXION XXL	Vredestein	20/18	630	1590
14827115	VF 600/70 R 30 NRO	168 D	TL	TRAXION OPTIMALL	Vredestein	21/20	605	1590
10927922	620/70 R 30	178 A8	TL	SFT	Mitas	18/20/21	625	1595
10927930	750/55 R 30	165 A8/162 D	TL	SFT	Mitas	23	720	1584
15225162	VF 710/60 R 30	171 D	TL	Agriflex 372+	Alliance	25	710	1615
15727124	IF 710/60 R 30 CFO	168 D	TL	Agrimax Force	BKT	25	708	1614
10629062	VF 710/60 R 30 NRO	167 D/164 E	TL	VT Tractor	Bridgestone	25/23	708	1614
10927935	710/60 R 30	165 A8/162 D	TL	SFT	Mitas	23	708	1646
13626380	710/60 R 30	162 D/159 E	TL	TM900HP	Trelleborg	23	710	1590
14826060	710/60 R 30	162 D	TL	TRAXION XXL	Vredestein	23/21/25	705	1610
10927938	710/65 R 30	182 A8	TL	SFT	Mitas	23/25	708	1698
15225157	IF 620/75 R 30 CFO	164 D	TL	Agriflex 372	Alliance	23/20/21	650	1675
15225158	620/75 R 30	169 A8/166 D	TL	Agristar 378 XL	Alliance	20	590	1692
15726795	620/75 R 30 CHO	168 A8/168 B	TL	Agrimax Teris	BKT	20	625	1692
15726260	IF 620/75 R 30 CFO	169 D	TL	Agrimax Force	BKT	23/21	650	1703

* = höhere Tragfähigkeit für Einsatz auf gezogenen Fahrzeugen, niedrigere Tragfähigkeit für Einsatz auf angetriebenen Fahrzeugen

¹ = **empfohlene Felge** / weitere zulässige Felgenbreiten

Alles auf einen Blick:

statischer Halbmesser in mm	Abrollumfang in mm	Tragfähigkeit in kg	km/h	Luftdruck in bar
667	4459	4125/3650	40/65	1,60
686	4616	5300	65	2,40
660	4571	5150/4625	65/70	1,60
668	4489	3650	65	1,60
674	4475	4750/4375	40/65	2,40
675	4510	5150	65	2,00
674	4745	5000/7100	40	2,80
680	4669	5000/7100	40	2,80
717	4710	3550	65	1,60
715	4724	6000	65	2,40
722	4765	3875/3550	40/65	1,60
711	4774	3550	65	1,60
724	4810	4625/4250	40/65	2,40
708	4800	5150	65	2,40
713	4759	5150/4750	65/70	2,40
702	4711	5600	65	2,00
722	4867	4250/3875	65/70	2,40
695	4783	5150/4625	65/70	1,60
722	4867	4250/3875	65/70	2,40
737	4760	4250	65	2,40
689	4659	5600/5150	65/70	2,00
700	4700	3875/3550	40/65	1,60
714	4820	5150/4625	65/70	3,20
722	4820	4250/3875	65/70	2,40
695	4785	6000/5450	65/70	2,40
725	4750	4250	65	2,40
695	4710	5600	65	2,00
680	4770	7500/5300	40	2,40
712	4725	5150/4750	40/65	2,40
696	4707	6150	65	2,00
714	4814	5600	65	2,40
692	4730	5450/5000	65/70	1,60
730	4870	5150/4750	40/65	2,40
720	4800	4750/4375	65/70	2,40
730	4800	4750	65	2,40
730	4950	8500	40	2,40
734	4879	5000	65	1,60
761	5025	5800/5300	40/65	3,20
779	5169	5600	40/50	3,20
759	5100	5800	65	2,40



Alliance Agriflex 372



Alliance Agriflex 372+

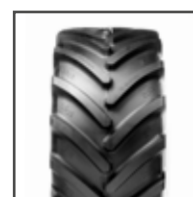

Alliance Agristar 378 XL



Alliance Agri Star II



BKT Agrimax Factor



BKT Agrimax Force

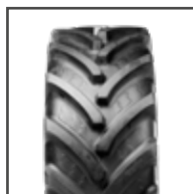

BKT Agrimax Fortis



BKT Agrimax RT 765

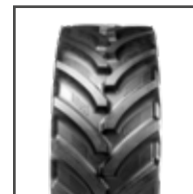

BKT Agrimax Sirio

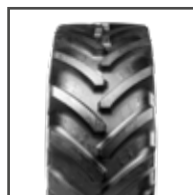

BKT Agrimax Teris

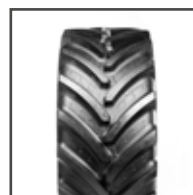

BKT Agrimax V-Flecto

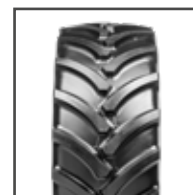

BKT RM 500



Bridgestone VT Tractor



Bridgestone VX-Tractor

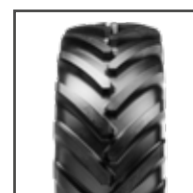

Michelin AxioBib 2



Michelin MachXBib

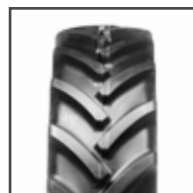

Mitas SFT

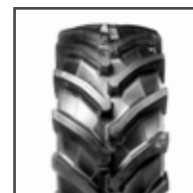

Trelleborg TM900HP

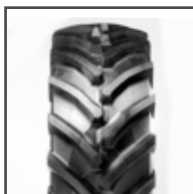

Trelleborg TM1000PT



Vredestein TRAXION OPTIMALL



Vredestein TRAXION XXL



AS Reifen Radial

Preise und Bestände finden Sie unter www.bohnenkamp.de/shop



Artikel-Nr.	Größe	Last-/ Speed-Index	TL/TT	Profil	Marke	Felge ¹	Breite in mm	Außen ø in mm
10000545	VF 620/75 R 30	169 D/166 E	TL	VTTractor	Bridgestone	23/20/21	654	1684
10626515	620/75 R 30	169 A8/169 B	TL	Maxi Traction Harvest	Firestone	18.00/20	595	1660
10626513	620/75 R 30	163 D/160 E	TL	Maxi Traction	Firestone	20	643	1690
13326932	VF 620/75 R 30	172 D/169 E	TL	AxioBib 2	Michelin	23/20/21	653	1676
10927923	620/75 R 30	169 A8/166 D	TL	SFT	Mitas	20/18/21	635	1700
14827140	VF 620/75 R 30	172 D	TL	TRAXION OPTIMALL	Vredestein	23/20/21	650	1665
15225161	IF 650/75 R 30 CFO	166 D	TL	Agriflex 372	Alliance	23/21	660	1720
13326948	IF 650/75 R 30	166 D	TL	AxioBib	Michelin	23	679	1721
15226070	8.3 R 32	119 A8/116 D	TL	350	Alliance	7/6	211	1190
10926480	270/80 R 32	131 A8/128 B	TL	AC 90	Mitas	10/8/9	280	1225
15727435	210/95 R 32	120 A8/120 B	TL	Agrimax RT 955	BKT	7/6	214	1213
15226100	9.5 R 32	131 A8/128 D	TL	350	Alliance	8/7	241	1245
15727445	230/95 R 32	128 A8/128 B	TL	Agrimax RT 955	BKT	8/7	238	1251
10627301	230/95 R 32	143 A2/128 D	TL	Performer 95	Firestone	8/7	220	1254
12426770	230/95 R 32	131 A8/128 D	TL	Cropker	Kleber	7/8	225	1256
10001046	230/95 R 32	128 A8/128 B	TL	TM100	Trelleborg	7/6	235	1265
15226125	11.2 R 32	135 A8/132 D	TL	350	Alliance	10/8/9	284	1300
15226126	VF 270/95 R 32	138 D	TL	Agriflex 363 +	Alliance	9/10	284	1330
15727450	270/95 R 32	136 A8/136 B	TL	Agrimax RT 955	BKT	9/8/10	275	1327
10627304	270/95 R 32	150 A2/136 D	TL	Performer 95	Firestone	9/8/10	267	1329
12426772	270/95 R 32	139 A8/136 D	TL	Cropker	Kleber	9/8/10	276	1320
10926481	270/95 R 32	136 A8/136 B	TL	AC 85	Mitas	9/8/10	275	1327
10001045	270/95 R 32	136 A8/136 B	TL	TM100	Trelleborg	9/8/10	280	1345
15227205	12.4 R 32	142 A8/139 B	TL	Power Drive 356	Alliance	11/9/10	315	1350
15228670	320/85 R 32	126 D	TL	Agri Star II	Alliance	11/9/10	333	1359
15726280	320/85 R 32	126 A8/126 B	TL	Agrimax RT 855	BKT	11/9/10	329	1357
12426402	320/85 R 32	126 A8/123 B	TL	Traker	Kleber	11/10	330	1356
10926482	320/85 R 32	142 A8/142 B	TL	AC 85	Mitas	9/10/11	309	1365
10627307	320/90 R 32	148 A2/134 D	TL	Performer 90	Firestone	10/9/11	310	1390
10926483	320/90 R 32	134 A8/134 B	TL	AC 85	Mitas	10/9/11	331	1391
15225280	650/75 R 32	172 A8/172 B	TL	Agristar 375	Alliance	21	670	1830
15726800	650/75 R 32 CHO	172 A8/172 B	TL	Agrimax Teris	BKT	21/20/23	670	1795
15727132	650/75 R 32	172 A8/172 B	TL	Agrimax RT 600	BKT	21/20/23	655	1789
10000557	IF 650/75 R 32 CFO	173 A8	TL	VT Combine	Bridgestone	21/23	646	1770
10626523	650/75 R 32	172 A8/172 B	TL	Maxi Traction Harvest	Firestone	20/21/23	630	1760
10927940	650/75 R 32	167 A8/164 B	TL	AC 75 G	Mitas	20/21	635	1798
10927960	650/75 R 32	167 A8/164 B	TL	AC 70 H	Mitas	20/21	650	1795
10927950	650/75 R 32	172 A8/169 B	TL	AC 70 G	Mitas	20/21	650	1795
13626390	650/75 R 32	172 A8	TL	TM2000	Trelleborg	20	662	1817
15224248	30.5LR32	178 A8/175 B	TL	360	Alliance	27	775	1820

¹ = empfohlene Felge / weitere zulässige Felgenbreiten

Alles auf einen Blick:

statischer Halbmesser in mm	Abrollumfang in mm	Tragfähigkeit in kg	km/h	Luftdruck in bar
730	4999	5800/5300	65/70	1,60
748	4966	5800	40/50	3,20
765	5092	4875/4500	65/70	2,40
720	4930	6300/5800	65/70	2,00
740	4980	5800/5300	40/65	2,80
725	4930	6300	65	2,00
754	5007	5300	65	1,60
745	5071	5300	65	1,60
553	3668	1360/1250	40/65	3,60
563	3690	1950/1800	40/50	4,00
571	3703	1400	40/50	3,20
582	3796	1950/1800	40/65	3,60
585	3810	1800	40/50	4,00
592	3861	2725/1800	10/65	4,00
587	3768	1950/1800	40/65	4,00
595	3900	1800	40/50	4,00
601	3996	2180/2000	40/65	3,60
609	3968	2360	65	2,40
614	4076	2240	40/50	4,00
629	4092	3350/2240	10/65	4,00
617	3957	2430/2240	40/65	4,00
602	3976	2240	40/50	4,00
635	4075	2240	40/50	4,00
627	4055	2650/2430	40/50	4,20
629	4090	1700	65	1,60
621	4081	1700	40/50	1,60
615	4037	1700/1550	40/50	1,60
625	4035	2650	40/50	4,00
657	4279	3150/2120	10/65	2,80
638	4190	2120	40/50	2,40
836	5442	6300	40/50	3,20
816	5378	6300	40/50	3,20
807	5416	6300	40/50	3,20
775	5292	6500	40	2,40
794	5271	6300	40/50	3,20
782	5245	5450/5000	40/50	2,40
790	5255	5450/5000	40/50	2,40
790	5255	6300/5800	40/50	3,20
805	5495	6300	40	3,20
809	5319	7500/6900	40/50	3,10



Alliance 350

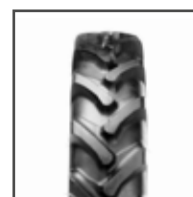

Alliance Power Drive 356

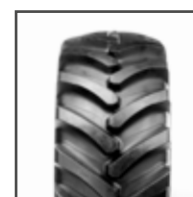

Alliance 360



Alliance Agriflex 372

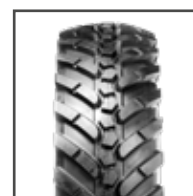

Alliance Agriflex 363+

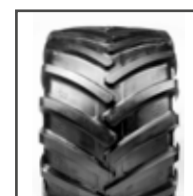

Alliance Agristar 375

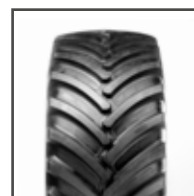

BKT Agrimax RT 600



BKT Agrimax RT 855



BKT Agrimax RT 955

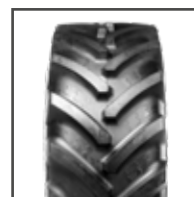

BKT Agrimax Teris

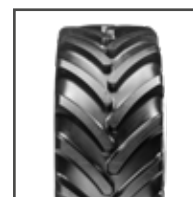

Bridgestone VT Combine

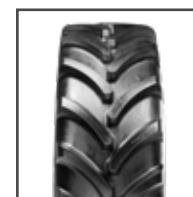

Firestone Maxi Traction Harvest



Firestone Performer 95



Kleber Cropker

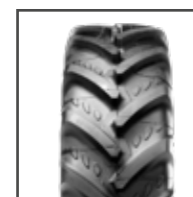

Kleber Traker



Michelin AxioBib / AxioBib 2



Mitas AC 70 H



Mitas AC 75 G

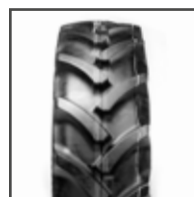

Mitas AC 85



Trelleborg TM100

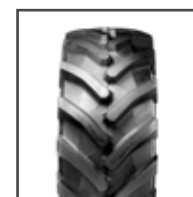

Trelleborg TM2000



AS Reifen Radial





Preise und Bestände finden Sie unter www.bohnenkamp.de/shop



Artikel-Nr.	Größe	Last-/ Speed-Index	TL/TT	Profil	Marke	Felge ¹	Breite in mm	Außen ø in mm
15226783	800/65 R 32	172 A8/172 B	TL	Agristar 375	Alliance	27	812	1856
15226767	800/65 R 32	181 A8/178 B	TL	360	Alliance	27	800	1850
15226764	VF 800/65 R 32	181 D	TL	Agristar 375	Alliance	27	805	1850
15225164	VF 800/65 R 32 CFO	184 D	TL	Agriflex 372+	Alliance	27	775	1845
15727125	800/65 R 32 CHO	178 A8/175 B	TL	Agrimax Teris	BKT	27/25	818	1853
15727127	800/65 R 32	181 A8/178 B	TL	Agrimax RT 600	BKT	27/25	775	1820
10000559	IF 800/65 R 32 CFO	178 A8	TL	VT Combine	Bridgestone	27	776	1836
13327090	IF 800/65 R 32 CFO+	181 A8	TL	CerexBib 2	Michelin	27	772	1855
10927970	800/65 R 32	172 A8/169 B	TL	AC 70 H	Mitas	25/27	795	1820
13626394	800/65 R 32	178 A8	TL	TM2000	Trelleborg	27/25/28	800	1846
13626400	IF 800/65 R 32 CFO	178 A8	TL	TM3000	Trelleborg	27	755	1850
15726805	IF 710/75 R 32 CFO	183 A8/183 B	TL	Agrimax Teris	BKT	25/23	716	1879
15226779	900/60 R 32	185 A8/182 D	TL	Agristar 375	Alliance	27/28/30	910	1905
15225169	IF 900/60 R 32 CFO	192 D	TL	Agriflex 372	Alliance	30/27	885	1890
15226761	900/60 R 32	194 A8/191 D	TL	Multistar 376	Alliance	27	869	1894
15727755	900/60 R 32	181 A8/178 B	TL	Agrimax RT 600	BKT	27/28/30	896	1893
15727128	900/60 R 32 CHO	185 A8/182 B	TL	Agrimax Teris	BKT	27/28/30	886	1910
10000562	IF 900/60 R 32 CFO	182 A8	TL	VT Combine	Bridgestone	30	850	1894
10927980	900/60 R 32	176 A8/173 B	TL	SFT	Mitas	27/30	857	1905
10928000	900/60 R 32 CHO	176 A8/173 B	TL	SFT	Mitas	27/30	835	1927
10001028	900/60 R 32	181 A8	TL	TM2000	Trelleborg	30/27/28	890	1900
15226766	1050/50 R 32	185 A8/182 D	TL	Multistar 376	Alliance	36	1050	1870
15226760	IF 1050/50 R 32 CFO	195 A8	TL	Multistar 376	Alliance	36	1050	1860
15727300	1050/50 R 32 CHO	184 A8/181 B	TL	Agrimax Teris	BKT	36.0	1059	1893
15727305	1050/50 R 32	184 A8/181 B	TL	Agrimax RT 600	BKT	36.0	1059	1863
13326966	1050/50 R 32	178 A8	TL	MegaXBib M28	Michelin	36	1038	1902
10927982	1050/50 R 32	178 A8/178 B	TL	SFT	Mitas	36	1015	1890
15226762	680/85 R 32	178 A8	TL	Multistar 376	Alliance	21	660	1960
15727134	IF 680/85 R 32	179 D	TL	Agrimax RT 600	BKT	23/21	682	1960
10000558	IF 680/85 R 32 CFO	179 A8	TL	VT Combine	Bridgestone	21/23	658	1946
13327018	IF 680/85 R 32 CFO	179 A8	TL	CerexBib	Michelin	23/21	682	1969
10927965	680/85 R 32	178 A8/175 B	TL	AC 70 G	Mitas	20/21/23	662	1950
10927967	680/85 R 32 CHO	178 A8/175 B	TL	AC 70 G	Mitas	20/21/23	663	1960
15225283	800/70 R 32 CHO	175 A8/175 B	TL	Agristar 375	Alliance	27/25	780	1935
15225167	IF 800/70 R 32 CFO	182 A8	TL	Agriflex 372	Alliance	27/25	784	1933
10000560	IF 800/70 R 32 CFO	182 A8	TL	VT Combine	Bridgestone	27	774	1933
13326986	800/70 R 32	181 A8/181 B	TL	MegaXBib	Michelin	25/27	793	1936
13327092	IF 800/70 R 32 CFO+	185 A8	TL	CerexBib 2	Michelin	27	796	1950
10927975	800/70 R 32	175 A8/172 B	TL	SFT	Mitas	25/27	762	1932

¹ = empfohlene Felge / weitere zulässige Felgenbreiten

Alles auf einen Blick:

				
statischer Halbmesser in mm	Abrollumfang in mm	Tragfähigkeit in kg	km/h	Luftdruck in bar
845	5529	6300	40/50	2,40
825	5533	8250/7500	40/50	3,60
808	5435	8250	65	2,00
804	5416	9000	65	2,40
838	5587	7500/6900	40/50	3,20
823	5558	8250/7500	40/50	3,60
804	5489	7500	40	2,40
826	5501	8250	40	2,80
830	5430	6300/5800	40/50	2,40
829	5595	7500	40	3,20
810	5575	7500	40	2,40
851	5653	8750	40/50	3,20
844	5700	9250/8500	40/65	3,20
847	5612	11200	65	4,00
850	5663	11800/10900	40/65	4,40
841	5697	8250/7500	40/50	3,20
875	5775	9250/8500	40/50	4,00
829	5659	8500	40	2,40
850	5700	7100/6500	40/50	2,40
851	5700	7100/6500	40/50	2,40
855	5765	8250	40	3,20
833	5656	9250/8500	40/65	3,20
833	5627	12150	40	4,00
840	5685	9000/8250	40/50	3,20
826	5700	9000/8250	40/50	3,20
854	5649	7500	40	2,40
845	5640	7500	40/50	2,40
882	5823	7500	40	3,20
846	5860	7750	65	2,40
852	5814	7750	40	2,40
861	5819	7750	40	2,40
852	5865	7500/6900	40/50	3,20
858	5865	7500/6900	40/50	3,20
877	5706	6900	40/50	2,40
857	5704	8500	40	2,40
846	5780	8500	40	2,40
871	5725	8250	40/50	3,20
864	5800	9250	40	2,80
845	5630	6900/6300	40/50	2,40

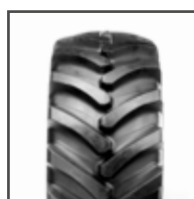

Alliance 360



Alliance Agriflex 372

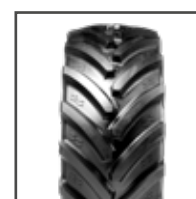

Alliance Agriflex 372+



Alliance Agristar 375



Alliance Multistar 376

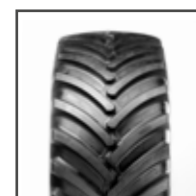

BKT Agrimax RT 600

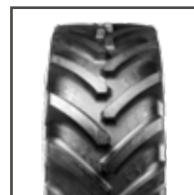

BKT Agrimax Teris

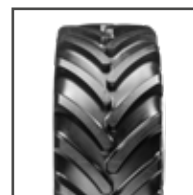

Bridgestone VT Combine



Michelin CerexBib / CerexBib 2



Michelin MegaXBib / MegaXBib M28

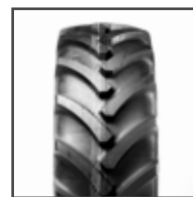

Mitas AC 70 G

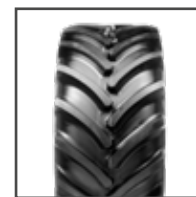

Mitas AC 70 H



Mitas SFT



Trelleborg TM2000

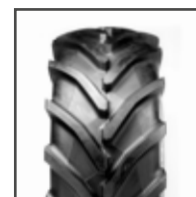

Trelleborg TM3000



AS Reifen Radial





Preise und Bestände finden Sie unter www.bohnenkamp.de/shop



Artikel-Nr.	Größe	Last-/ Speed-Index	TL/TT	Profil	Marke	Felge ¹	Breite in mm	Außen ø in mm
10927977	800/70 R 32 CHO	175 A8/172 B	TL	SFT	Mitas	25/27	748	1932
13626403	IF 800/70 R 32 CFO	182 A8	TL	TM3000	Trelleborg	27	775	1950
10928065	900/70 R 32 CHO	182 A8/179 B	TL	SFT	Mitas	27/30	881	2061
10928060	900/70 R 32	188 A8/185 B	TL	SFT	Mitas	27/30	895	2050
15225171	IF 1250/50 R 32 CFO	201 B	TL	Agriflex 372	Alliance	44	1250	2080
10000133	320/85 R 34	133 D	TL	Agri Star II	Alliance	11/9/10	319	1408
15226130	320/85 R 34	141 A8	TL	350	Alliance	11/10	329	1408
15726290	320/85 R 34	141 A8/141 B	TL	Agrimax RT 855	BKT	11/9/10	329	1408
13328211	320/85 R 34	133 A8/133 B	TL	AgriBib 2	Michelin	10	312	1421
10927983	320/85 R 34	133 A8/133 B	TL	AC 85	Mitas	10/9/11	326	1430
15228680	380/85 R 34	137 D	TL	Agri Star II	Alliance	12/11/13	385	1510
15226133	VF 380/85 R 34	149 D	TL	Agriflex 354 +	Alliance	13/12	395	1524
15726295	380/85 R 34	137 A8/137 B	TL	Agrimax RT 855	BKT	12/11/13	380	1509
13328214	380/85 R 34	142 A8/142 B	TL	AgriBib 2	Michelin	12/13	378	1516
13327980	VF 380/85 R 34	149 B	TL	YieldBib	Michelin	13/12	386	1510
10927985	380/85 R 34	146 A8/146 B	TL	AC 85	Mitas	12/11/13	401	1538
14826388	380/85 R 34	137 A8/137 B	TL	Traxion 85 II	Vredestein	12/11/13	390	1505
15228691	420/85 R 34	142 D	TL	Agri Star II	Alliance	15/14/13	443	1578
15228692	420/85 R 34	147 D	TL	Agri Star II	Alliance	15/14/13	443	1578
15726300	420/85 R 34	142 A8/142 B	TL	Agrimax RT 855	BKT	15/13/14	438	1578
15726302	420/85 R 34	147 A8/147 B	TL	Agrimax RT 855	BKT	15/13/14	438	1578
10000512	420/85 R 34	147 D/144 E	TL	VX-Tractor	Bridgestone	15/14	442	1580
10626366	420/85 R 34	142 D/139 E	TL	Performer 85	Firestone	15/14	453	1572
12426425	420/85 R 34	142 A8/139 B	TL	Traker	Kleber	15/14	442	1581
13326430	420/85 R 34	147 A8/147 B	TL	AgriBib 2	Michelin	15/13/14	438	1578
13327981	VF 420/85 R 34	154 A8/154 B	TL	YieldBib	Michelin	15/14	432	1582
10927990	420/85 R 34	142 A8/142 B	TL	AC 85	Mitas	15/13/14	471	1598
10927995	420/85 R 34	147 A8/147 B	TL	AC 85	Mitas	15/13/14	469	1593
13626420	420/85 R 34	142 A8/139 B	TL	TM600	Trelleborg	15/14	438	1578
14826390	420/85 R 34	142 A8/142 B	TL	TRAXION 85	Vredestein	15/13/14	455	1570
10000958	VF 420/95 R 34	157 D	TL	Agriflex 354 +	Alliance	14/13	419	1662
15228879	480/70 R 34	143 D	TL	Agri Star II	Alliance	15/14/16	482	1580
15228152	480/70 R 34	155 D	TL	Agri Star II	Alliance	15/14/16	482	1580
15226136	VF 480/70 R 34	160 D	TL	Agriflex 354 +	Alliance	16	495	1580
15726809	480/70 R 34	149 D	TL	Agrimax RT 765	BKT	15/14/16	479	1580
10000921	480/70 R 34	152 A8/149 D	TL	Agrimax Factor	BKT	15/14/16	479	1580
15726807	480/70 R 34	155 D	TL	Agrimax RT 765	BKT	15/14/16	479	1580
10000922	480/70 R 34	158 A8/155 D	TL	Agrimax Factor	BKT	15/14/16	479	1580
10000514	480/70 R 34	149 D/146 E	TL	VX-Tractor	Bridgestone	15/14/16	484	1575
10626735	480/70 R 34	143 D/140 E	TL	Performer 70	Firestone	15/14/16	487	1592
12426436	480/70 R 34	143 A8/143 B	TL	Fitker	Kleber	15/14/16	497	1592

¹ = empfohlene Felge / weitere zulässige Felgenbreiten

Alles auf einen Blick:

				
statischer Halbmesser in mm	Abrollumfang in mm	Tragfähigkeit in kg	km/h	Luftdruck in bar
845	5630	6900/6300	40/50	2,40
850	5845	8500	40	2,40
904	6075	8500/7750	40/50	2,40
896	6050	10000/9250	40/50	3,20
905	6211	14500	50	3,20
654	4186	2060	65	2,40
652	4239	2575	40	3,60
645	4280	2575	40/50	3,60
653	4243	2060	40/50	2,40
650	4285	2060	40/50	2,40
699	4513	2300	65	1,60
679	4503	3250	65	1,60
682	4504	2300	40/50	1,60
687	4519	2650	40/50	2,40
668	4471	3250	40/50	1,60
699	4577	3000	40/50	2,40
680	4470	2300	40/50	1,60
730	4780	2650	65	1,60
728	4780	3075	65	2,40
709	4702	2650	40/50	1,60
709	4702	3075	40/50	2,40
728	4733	3075/2800	65/70	2,40
706	4716	2650/2430	65/70	1,60
708	4693	2650/2430	40/50	1,60
707	4685	3075	40/50	2,40
699	4682	3750	40/50	1,60
724	4761	2650	40/50	1,60
722	4755	3075	40/50	2,40
715	4745	2650/2430	40/50	1,60
735	4700	2650	40/50	1,60
731	4927	4125	65	1,60
700	4664	2725	65	1,60
700	4664	3875	65	3,20
714	4719	4500	65	2,40
711	4759	3250	65	2,40
723	4748	3550/3250	40/65	2,40
711	4759	3875	65	3,20
729	4761	4250/3875	40/65	3,20
721	4700	3250/3000	65/70	2,40
718	4776	2725/2500	65/70	1,60
707	4745	2725	40/50	1,60



Alliance 350

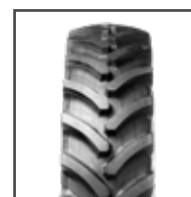

Alliance Agriflex 354 +



Alliance Agriflex 372



Alliance Agri Star II

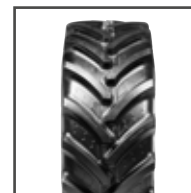

BKT Agrimax Factor



BKT Agrimax RT 765



BKT Agrimax RT 855



Bridgestone VX-Tractor

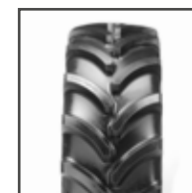

Firestone Performer 70

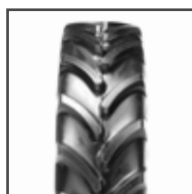

Firestone Performer 85



Kleber Fitker



Kleber Traker



Michelin AgriBib 2



Michelin YieldBib

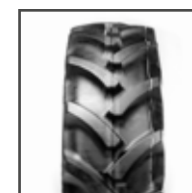

Mitas AC 85



Mitas SFT



Trelleborg TM600



Trelleborg TM3000



Vredestein TRAXION 85 / Traxion 85 II



AS Reifen Radial

Preise und Bestände finden Sie unter www.bohnenkamp.de/shop



Artikel-Nr.	Größe	Last-/ Speed-Index	TL/TT	Profil	Marke	Felge ¹	Breite in mm	Außen ø in mm
13327950	480/70 R 34	143 D	TL	OmniBib	Michelin	15/14/16	497	1593
10928005	480/70 R 34	143 A8/143 B	TL	AC 70 G	Mitas	15/14/16	486	1580
10928015	480/70 R 34	143 A8/143 B	TL	AC 70 T	Mitas	15/14/16	490	1575
10928010	480/70 R 34	146 A8/143 D	TL	HC 70	Mitas	15/14/16	494	1590
13626432	480/70 R 34	143 A8/143 B	TL	TM700	Trelleborg	15/14/16	468	1580
10000302	480/70 R 34	143 D	TL	TRAXION 70	Vredestein	15/14/16	485	1575
15226786	540/65 R 34	155 A8/152 D	TL	Agristar 365	Alliance	16/15/18	533	1570
15727130	540/65 R 34	155 A8/152 D	TL	Agrimax RT 657	BKT	16/15/18	530	1566
15727129	540/65 R 34	152 D/149 E	TL	Agrimax Sirio	BKT	16/18	530	1566
10000522	540/65 R 34	152 D/149 E	TL	VX-Tractor	Bridgestone	16/18	521	1571
10629064	VF 540/65 R 34 NRO	157 D/154 E	TL	VTTractor	Bridgestone	18/16	528	1566
12427080	540/65 R 34	145 D	TL	Gripker	Kleber	16/18	527	1588
13327640	540/65 R 34	145 D	TL	MultiBib	Michelin	16/18	530	1574
10928020	540/65 R 34	148 A8/145 D	TL	AC 65	Mitas	16/15/18	526	1580
13626455	540/65 R 34	145 D	TL	TM800	Trelleborg	16/15/18	530	1566
13626456	540/65 R 34	152 D/149 E	TL	TM800	Trelleborg	16/15/18	530	1566
14825800	540/65 R 34	145 D	TL	TRAXION 65	Vredestein	16/15/18	540	1580
14825801	540/65 R 34	152 D	TL	TRAXION 65	Vredestein	16/15/18	540	1580
10001572	VF 600/60 R 34	149 D	TL	Agriflex 372+	Alliance	20/21/18	587	1584
13327835	VF 600/60 R 34	149 D	TL	XeoBib	Michelin	20	595	1595
15228701	460/85 R 34	147 D	TL	Agri Star II	Alliance	16/14/15	480	1646
15228702	460/85 R 34	157 D	TL	Agri Star II	Alliance	16/14/15	480	1646
15726310	460/85 R 34	147 A8/147 B	TL	Agrimax RT 855	BKT	16/14/15	475	1646
15726309	460/85 R 34	158 A8/158 B	TL	Agrimax RT 855	BKT	16/14/15	475	1646
10000513	460/85 R 34	152 D/149 E	TL	VX-Tractor	Bridgestone	16/15	479	1637
10626376	460/85 R 34	147 D/144 E	TL	Performer 85	Firestone	16/15	487	1652
12426440	460/85 R 34	147 A8/144 B	TL	Traker	Kleber	16/15	488	1659
10928025	460/85 R 34	147 A8/147 B	TL	AC 85	Mitas	16/15/14	518	1676
13626445	460/85 R 34	147 A8/144 B	TL	TM600	Trelleborg	16/15	475	1646
14826395	460/85 R 34	147 A8/147 B	TL	TRAXION 85	Vredestein	16/14/15	490	1640
15225173	520/70 R 34	168 A8/165 B	TL	370	Alliance	16/18	516	1632
15228881	520/70 R 34	148 D	TL	Agri Star II	Alliance	16/15/18	520	1640
15726821	520/70 R 34	148 D	TL	Agrimax RT 765	BKT	16/15/18	516	1640
10626745	520/70 R 34	148 D/145 E	TL	Performer 70	Firestone	16/15/18	524	1643
12426457	520/70 R 34	148 A8/148 B	TL	Fitker	Kleber	16/15/18	535	1654
13327955	520/70 R 34	148 D	TL	OmniBib	Michelin	16/15/18	535	1651
10928030	520/70 R 34	148 A8/148 B	TL	AC 70 G	Mitas	16/15/18	539	1649
10928040	520/70 R 34	151 A8/148 D	TL	HC 70	Mitas	16/15/18	539	1651
13626452	520/70 R 34	148 A8/148 B	TL	TM700	Trelleborg	16/15/18	520	1638
10000293	520/70 R 34	148 D	TL	TRAXION 70	Vredestein	16/15/18	525	1640
15226811	600/65 R 34	160 A8/157 D	TL	Agristar 365	Alliance	18/20	590	1644
15727140	600/65 R 34	160 A8/157 D	TL	Agrimax RT 657	BKT	20/18	611	1644

¹ = empfohlene Felge / weitere zulässige Felgenbreiten

Alles auf einen Blick:

statischer Halbmesser in mm	Abrollumfang in mm	Tragfähigkeit in kg	km/h	Luftdruck in bar
713	4728	2725	65	1,60
716	4711	2725	40/50	1,60
710	4686	2725	40/50	1,60
704	4710	3000/2725	40/65	1,60
716	4720	2725	40/50	1,60
715	4645	2725	65	1,60
718	4670	3875/3550	40/65	2,40
712	4742	3875/3550	40/65	2,40
721	4735	3550/3250	65/70	2,40
698	4709	3550/3250	65/70	2,40
671	4625	4125/3750	65/70	1,60
698	4695	2900	65	1,60
693	4655	2900	65	1,60
709	4709	3150/2900	40/65	1,60
710	4710	2900	65	1,60
710	4710	3550/3250	65/70	2,40
740	4755	2900	65	1,60
740	4755	3550	65	2,40
696	4647	3250	65	1,00
690	4699	3250	65	1,00
753	4909	3075	65	1,60
753	4909	4125	65	3,00
721	4865	3075	40/50	1,60
721	4865	4250	40/50	3,20
754	4904	3550/3250	65/70	2,40
745	4956	3075/2800	65/70	1,60
737	4916	3075/2800	40/50	1,60
756	4982	3075	40/50	1,60
745	4945	3075/2800	40/50	1,60
765	4915	3075	40/50	1,60
739	4826	5600/5150	40/50	4,40
745	4891	3150	65	1,60
739	4927	3150	65	1,60
737	4929	3150/2900	65/70	1,60
734	4901	3150	40/50	1,60
730	4887	3150	65	1,60
740	4930	3150	40/50	1,60
735	4905	3450/3150	40/65	1,60
728	4875	3150	40/50	1,60
740	4840	3150	65	1,60
740	4904	4500/4125	40/65	2,40
742	4960	4500/4125	40/65	2,40

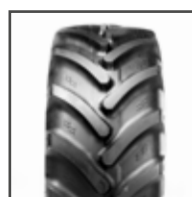

Alliance Agristar 365



Alliance 370



BKT Agrimax RT 657

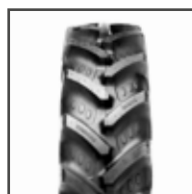

BKT Agrimax RT 855



BKT Agrimax Sirio



Bridgestone
VT Tractor

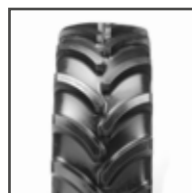

Firestone
Performer 70



Kleber Gripker



Kleber Traker

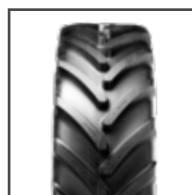

Michelin MultiBib

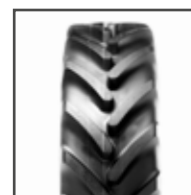

Michelin OmniBib



Michelin XeoBib

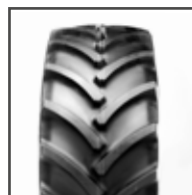

Mitas AC 65

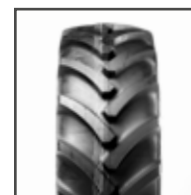

Mitas AC 70 G



Mitas AC 70 T



Mitas HC 70



Trelleborg TM700

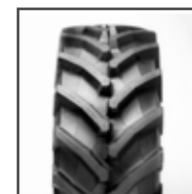

Trelleborg TM800



Vredestein
TRAXION 65



Vredestein
TRAXION 70

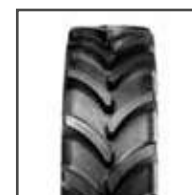

Vredestein
TRAXION 85



AS Reifen Radial

Preise und Bestände finden Sie unter www.bohnenkamp.de/shop



Artikel-Nr.	Größe	Last-/ Speed-Index	TL/TT	Profil	Marke	Felge ¹	Breite in mm	Außen ø in mm
10000900	VF 600/65 R 34 NRO	169 D	TL	Agrimax V-Flecto	BKT	21/20	597	1644
10000523	600/65 R 34	157 D/154 E	TL	VX-Tractor	Bridgestone	20/18	584	1644
10629066	VF 600/65 R 34	163 D/159 E	TL	VT Tractor	Bridgestone	21/20	597	1644
10627202	600/65 R 34	151 D/148 E	TL	Maxi Traction 65	Firestone	18/20	590	1639
12427090	600/65 R 34	151 D	TL	Gripker	Kleber	20/18	603	1639
13327645	600/65 R 34	151 D	TL	MultiBib	Michelin	20/18	594	1654
10928050	600/65 R 34	154 A8/151 D	TL	AC 65	Mitas	18/16/20	592	1648
10928048	600/65 R 34	160 A8/157 D	TL	AC 65	Mitas	18/16/20	592	1664
17427420	600/65 R 34	163 D/159 E	TL	Ground King	Nokian	20/18	600	1649
13626457	600/65 R 34	151 D	TL	TM800	Trelleborg	20	600	1644
13626461	600/65 R 34	157 D/154 E	TL	TM800HS	Trelleborg	20	600	1660
14825805	600/65 R 34	151 D	TL	TRAXION 65	Vredestein	18/20	595	1635
15727144	VF 650/60 R 34	168 D	TL	Agrimax V-Flecto	BKT	23/21	660	1676
10000549	VF 650/60 R 34	165 D/162 E	TL	VT Tractor	Bridgestone	23/20/21	650	1644
10926460	650/60 R 34	162 A8/159 D	TL	SFT	Mitas	20/21/23	650	1638
13626475	650/60 R 34	159 D/156 E	TL	TM900HP	Trelleborg	20/18	645	1650
14827110	VF 650/60 R 34 NRO	168 D	TL	TRAXION OPTIMALL	Vredestein	23/20/21	650	1660
10000969	VF 650/60 R 34 NRO	168 D/165 E	TL	TM1000PT	Trelleborg	23	650	1670
13626463	710/55 R 34	164 D/161 E	TL	TM900HP	Trelleborg	23	712	1633
10927027	500/85 R 34	178 A8/166 A8*	TL	SFT	Mitas	16/15	503	1705
15225177	600/70 R 34	163 A8/160 D	TL	Agristar 378 XL	Alliance	20/18	610	1705
15726850	600/70 R 34	163 A8/160 D	TL	Agrimax Fortis	BKT	18/20	591	1704
15726851	IF 600/70 R 34	167 D	TL	Agrimax Force	BKT	21/20	603	1704
10000524	600/70 R 34	160 D/157 E	TL	VX-Tractor	Bridgestone	20/18	590	1704
10629070	VF 600/70 R 34	167 D/164 E	TL	VT Tractor	Bridgestone	21/20	603	1708
17427422	600/70 R 34	167 D/163 E	TL	Ground King	Nokian	20/18	600	1704
13626470	600/70 R 34	160 D/157 E	TL	TM900HP	Trelleborg	18/20	600	1685
14826070	600/70 R 34	160 D	TL	TRAXION XXL	Vredestein	18/20	610	1700
13328050	VF 650/60 R 34	168 D/165 E	TL	AxioBib 2	Michelin	23/21/24	677	1653
15225179	VF 650/65 R 34 NRO	167 D	TL	Agriflex 372+	Alliance	23/20	650	1720
15727145	IF 650/65 R 34 CFO	161 D	TL	Agrimax Force	BKT	23	650	1710
10000900	VF 650/65 R 34 NRO	169 D	TL	Agrimax V-Flecto	BKT	21/20	597	1644
10000551	VF 650/65 R 34 NRO	167 D/164 E	TL	VT Tractor	Bridgestone	23/20/21	658	1702
13328076	VF 650/65 R 34	170 D/167 E	TL	AxioBib 2	Michelin	23	674	1722
10928055	650/65 R 34	164 A8/161 D	TL	SFT	Mitas	18/20	654	1719
17427424	650/65 R 34	167 D/164 E	TL	Ground King	Nokian	20	650	1700
10000971	VF 650/65 R 34 NRO	170 D/167 E	TL	TM1000PT	Trelleborg	23	660	1720
14827113	VF 650/65 R 34 NRO	170 D	TL	TRAXION OPTIMALL	Vredestein	23/20/21	655	1715
15726320	IF 680/60 R 34	165 D	TL	Agrimax Force	BKT	23	650	1644

* = höhere Tragfähigkeit für Einsatz auf gezogenen Fahrzeugen, niedrigere Tragfähigkeit für Einsatz auf angetriebenen Fahrzeugen

¹ = **empfohlene Felge** / weitere zulässige Felgenbreiten

Alles auf einen Blick:

statischer Halbmesser in mm	Abrollumfang in mm	Tragfähigkeit in kg	km/h	Luftdruck in bar
731	4952	5800	65	2,40
730	4923	4125/3750	65/70	2,40
706	4866	4875/4375	65/70	1,60
737	4923	3450/3150	65/70	1,60
721	4845	3450	65	1,60
732	4897	3450	65	1,60
737	4904	3750/3450	40/65	1,60
740	4915	4500/4125	40/65	2,40
751	5016	4875/4375	65/70	3,20
740	4920	3450	65	1,60
745	4965	4125/3750	65/70	2,40
770	4930	3450	65	1,60
750	4996	5600	65	2,00
721	4885	5150/4750	65/70	1,60
740	4935	4750/4375	40/65	2,40
750	4965	4375/4000	65/70	2,40
750	4935	5600	65	2,00
740	4960	5600/5150	65/70	2,00
752	4970	5000/4625	65/70	2,80
745	5000	7500/5300	40	2,80
770	5118	4875/4500	40/65	2,40
761	5109	4875/4500	40/65	2,40
757	5070	5450	65	2,40
771	5110	4500/4125	65/70	2,40
740	5071	5450/5000	65/70	1,60
771	5170	5450/4875	65/70	3,20
755	5105	4500/4125	65/70	2,40
775	5060	4500	65	2,40
732	4895	5600/5150	65/70	2,00
753	4960	5450	65	1,60
764	5078	4625	65	1,60
731	4952	5800	65	2,40
725	5131	5450/5000	65/70	1,60
761	5091	6000/5450	65/70	2,00
769	5116	5000/4625	40/65	2,40
769	5173	5450/5000	65/70	3,20
755	5085	6000/5450	65/70	2,00
775	5100	6000	65	2,00
746	4954	5150	65	2,40



Alliance Agriflex 372+

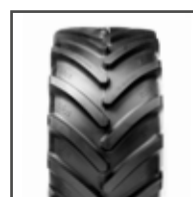

Alliance Agristar 378 XL



BKT Agrimax Force

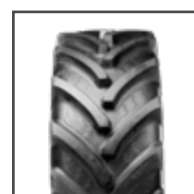

BKT Agrimax Fortis

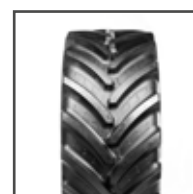

BKT Agrimax V-Flecto



Bridgestone VT Tractor

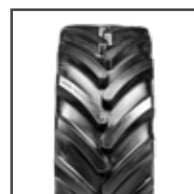

Bridgestone VX-Tractor



Firestone Maxi Traction 65



Kleber Gripker



Michelin AxioBib 2



Michelin MultiBib

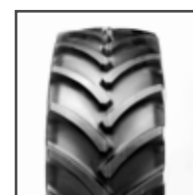

Mitas AC 65



Mitas SFT



Nokian Ground King

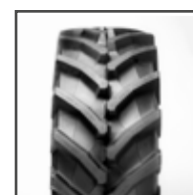

Trelleborg TM800 / TM800HS

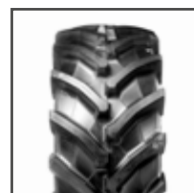

Trelleborg TM900HP

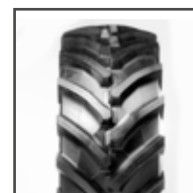

Trelleborg TM1000PT

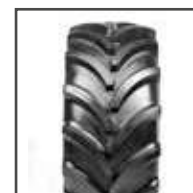

Vredestein TRAXION 65



Vredestein TRAXION OPTIMALL



Vredestein TRAXION XXL



AS Reifen Radial

Preise und Bestände finden Sie unter www.bohnenkamp.de/shop



Artikel-Nr.	Größe	Last-/ Speed-Index	TL/TT	Profil	Marke	Felge ¹	Breite in mm	Außen ø in mm
15225180	710/60 R 34	167 A8/164 D	TL	Agristar 378 XL	Alliance	23	710	1712
15727153	IF 710/60 R 34 CFO	170 D	TL	Agrimax Force	BKT	25	708	1716
15727154	VF 710/60 R 34 NRO	173 D	TL	Agrimax V-Flecto	BKT	25/24/27/23	708	1716
15225181	VF 710/60 R 34	173 D	TL	Agriflex 372+	Alliance	25/24/27	710	1715
10629072	VF 710/60 R 34 NRO	169 D/166 E	TL	VT Tractor	Bridgestone	25/23	708	1716
13328053	VF 710/60 R 34	173 D/169 E	TL	AxioBib 2	Michelin	25/23	731	1757
10926462	710/60 R 34	167 A8/164 D	TL	SFT	Mitas	23	700	1700
13626465	710/60 R 34	164 D/161 E	TL	TM900HP	Trelleborg	23	715	1700
10000970	VF 710/60 R 34 NRO	173 D/170 E	TL	TM1000PT	Trelleborg	25/23	710	1715
14827112	VF 710/60 R 34 NRO	173 D	TL	TRAXION OPTIMALL	Vredestein	25/23	705	1705
15726312	IF 580/80 R 34 CFO	177 D	TL	Agrimax Teris	BKT	20/21	586	1792
15225286	620/75 R 34	170 A8/170 B	TL	Agristar 375	Alliance	20/18	610	1820
13327000	620/75 R 34	170 A8/170 B	TL	MegaXBib	Michelin	20/18	590	1814
15225290	710/75 R 34	178 A8/178 B	TL	Agristar 375	Alliance	23/21	720	1945
15726855	IF 710/75 R 34 CFO	178 D	TL	Agrimax Force	BKT	25	716	1929
15726856	IF 710/75 R 34 CFO	184 A8/184 B	TL	Agrimax Teris	BKT	25/23	716	1930
15226140	8.3 R 36	121 A8/118 D	TL	350	Alliance	7/6	211	1290
15727464	270/80 R 36	134 A8/134 B	TL	Agrimax RT 955	BKT	9/8/10	275	1346
10926484	270/80 R 36	134 A8/131 B	TL	AC 90	Mitas	10/8/9	280	1345
15226150	9.5 R 36	133 A8/130 D	TL	350	Alliance	8/7	241	1345
15727460	230/95 R 36	130 A8/130 B	TL	Agrimax RT 955	BKT	8/7	238	1352
10627317	230/95 R 36	145 A2/130 D	TL	Performer 95	Firestone	8/7	239	1351
12426775	230/95 R 36	133 A8/130 D	TL	Cropker	Kleber	7/8	225	1352
10001027	230/95 R 36	130 A8/130 B	TL	TM100	Trelleborg	7/6	235	1365
15226165	11.2 R 36	139 A8/136 D	TL	350	Alliance	10/8/9	284	1410
15227295	VF 270/95 R 36	140 D	TL	Agriflex 363 +	Alliance	9/10	276	1424
15727465	270/95 R 36	139 A8/139 B	TL	Agrimax RT 955	BKT	9/8/10	275	1428
10627318	270/95 R 36	153 A2/139 D	TL	Performer 95	Firestone	9/8/10	270	1431
12426777	270/95 R 36	142 A8/139 D	TL	Cropker	Kleber	9/8/10	275	1415
15224282	12.4 R 36	146 A8/143 B	TL	Power Drive 356	Alliance	11/9/10	315	1450
15228710	320/85 R 36	128 D	TL	Agri Star II	Alliance	11/9/10	333	1460
15726340	320/85 R 36	128 A8/128 B	TL	Agrimax RT 855	BKT	11/9/10	329	1458
10626381	320/85 R 36	128 D/125 E	TL	Performer 85	Firestone	11/9/10	321	1459
12426543	320/85 R 36	128 A8/125 B	TL	Traker	Kleber	11/10	323	1461
13326535	12.4/ R 36	124 A8/121 B	TL	AgriBib	Michelin	11/10	318	1460
13626480	12.4 R 36	124 A8/121 B	TT	TM190	Trelleborg	11/9/10	307	1446
15228715	340/85 R 36	132 D	TL	Agri Star II	Alliance	12/11	355	1496
15726350	340/85 R 36	132 A8/132 B	TL	Agrimax RT 855	BKT	12/11	353	1492
10626386	340/85 R 36	132 D/129 E	TL	Performer 85	Firestone	12/11	348	1492
12426544	340/85 R 36	132 A8/129 B	TL	Traker	Kleber	12/11	354	1503
10928080	13.6 R 36	127 A8/124 B	TL	AC 90	Mitas	12/11	360	1499

¹ = empfohlene Felge / weitere zulässige Felgenbreiten

Alles auf einen Blick:

statischer Halbmesser in mm	Abrollumfang in mm	Tragfähigkeit in kg	km/h	Luftdruck in bar
771	5128	5450/5000	40/65	2,40
763	5126	6000	65	2,40
752	5097	6500	65	2,00
753	5105	6500	65	2,00
736	5044	5800/5300	65/70	1,60
754	5093	6500/5800	65/70	2,00
770	5060	5450/5000	40/65	2,40
775	5125	5000/4625	65/70	2,40
750	5125	6500/6000	65/70	2,00
750	5060	6500	65	2,00
810	5422	7300	65	3,60
828	5435	6000	40/50	3,20
821	5398	6000	40/50	3,20
880	5789	7500	40/50	3,20
864	5750	7500	65	2,40
870	5852	9000	40/50	3,20
607	4023	1450/1320	40/65	3,60
629	4090	2120	40/50	4,00
623	4015	2120/1950	40/50	4,00
625	3981	2060/1900	40/65	3,60
639	4112	1900	40/50	4,00
639	4159	2900/1900	10/65	4,00
632	4035	2060/1900	40/65	4,00
645	4210	1900	40/50	4,00
654	4327	2430/2240	40/65	3,60
660	4287	2500	65	2,40
665	4368	2430	40/50	4,00
676	4406	3650/2430	10/65	4,00
664	4245	2650/2430	40/65	4,00
677	4369	3000/2725	40/50	3,80
680	4369	1800	65	1,60
672	4404	1800	40/50	1,60
654	4377	1800/1650	65/70	1,60
667	4357	1800/1650	40/50	1,60
673	4363	1600/1450	40/50	1,60
671	4390	1600/1450	40/50	1,60
696	4462	2000	65	1,60
689	4507	2000	40/50	1,60
672	4476	2000/1850	65/70	1,60
684	4478	2000/1850	40/50	1,60
692	4492	1750/1600	40/50	1,60

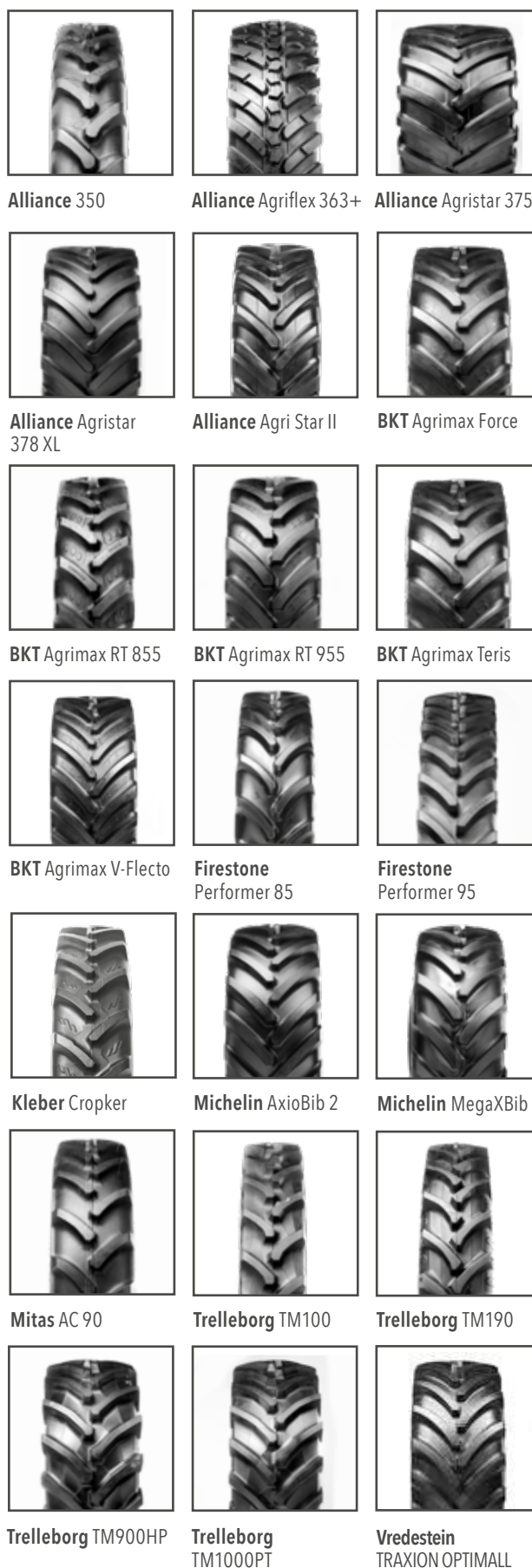



AS Reifen Radial

Preise und Bestände finden Sie unter www.bohnenkamp.de/shop



Artikel-Nr.	Größe	Last-/ Speed-Index	TL/TT	Profil	Marke	Felge ¹	Breite in mm	Außen ø in mm
15226185	11.2 R 38	140 A8/137 D	TL	350	Alliance	10/8/9	284	1456
15226186	VF 270/95 R 38	141 D	TL	Agriflex 363 +	Alliance	9/10	278	1476
15727475	270/95 R 38	140 A8/140 B	TL	Agrimax RT 955	BKT	9/8/10	275	1479
10627319	270/95 R 38	154 A2/140 D	TL	Performer 95	Firestone	9/8/10	275	1478
12426780	270/95 R 38	143 A8/140 D	TL	Cropker	Kleber	9/8/10	274	1469
15228717	320/85 R 38	143 D	TL	Agri Star II	Alliance	11/9/10	333	1511
15726360	320/85 R 38	143 A8/143 B	TL	Agrimax RT 855	BKT	10/9/11	319	1509
13326552	IF 320/85 R 38	151 A8/151 B	TL	AgriBib RC	Michelin	11/10	330	1506
10926522	320/85 R 38	143 A8/143 B	TL	AC 85	Mitas	10/9/11	322	1518
13626551	320/85 R 38	129 A8/126 B	TL	TM600	Trelleborg	11/9/10	325	1520
15228720	340/85 R 38	133 D	TL	Agri Star II	Alliance	12/11	355	1546
15726370	340/85 R 38	133 A8/133 B	TL	Agrimax RT 855	BKT	12/11	353	1543
10626416	340/85 R 38	133 D/130 E	TL	Performer 85	Firestone	12/11	351	1553
12426575	340/85 R 38	133 A8/130 B	TL	Traker	Kleber	12/11	361	1563
13326555	13.6 R 38	128 A8/125 B	TL	AgriBib	Michelin	12/11	358	1565
10928110	340/85 R 38	133 A8/133 B	TL	AC 85	Mitas	12/11	365	1562
10926524	340/85 R 38	148 A8/148 B	TL	AC 85	Mitas	11/12	355	1562
13626560	340/85 R 38	133 A8/130 B	TL	TM600	Trelleborg	12/11	353	1543
14826400	340/85 R 38	133 A8/133 B	TL	TRAXION 85	Vredestein	12/11	360	1550
15228725	380/80 R 38	142 D	TL	Agri Star II	Alliance	12/11/13	385	1575
15228727	380/80 R 38	152 D	TL	Agri Star II	Alliance	12/11/13	385	1575
15227329	VF 380/80 R 38	154 D	TL	Agriflex 354 +	Alliance	13/12	382	1591
10000974	VF 380/80 R 38	154 D	TL	Agriflex 363 +	Alliance	12	380	1590
15727170	IF 380/80 R 38	149 D	TL	Agrimax Force	BKT	12/11/13	380	1573
13326566	380/80 R 38	142 A8/139 D	TL	AgriBib 2	Michelin	12/13	380	1595
13327987	VF 380/80 R 38	149 A8/149 B	TL	YieldBib	Michelin	12/13	366	1592
10928115	380/80 R 38	142 A8/142 B	TL	AC 85	Mitas	12/11/13	380	1590
13626575	380/80 R 38	142 A8/142 B	TL	TM600	Trelleborg	12/11/13	400	1575
14826520	380/80 R 38	142 A8/142 B	TL	TRAXION 85	Vredestein	12/11/13	390	1580
15726380	380/85 R 38	139 A8/139 B	TL	Agrimax RT 855	BKT	12/11/13	380	1611
15726382	VF 380/85 R 38	161 D	TL	Agrimax Spargo	BKT	13/12	380	1602
13626580	380/85 R 38	144 A8/144 B	TL	TM600	Trelleborg	13/11/12	400	1610
15227328	IF 380/95 R 38	154 D	TL	Agriflex 354	Alliance	13/12	390	1687
13327989	VF 380/95 R 38	154 A8/154 B	TL	YieldBib	Michelin	12	377	1703
15227330	15.5 R 38	134 A8/131 B	TL	Power Drive 356	Alliance	14	394	1570
15227827	400/75 R 38	134 A8/134 B	TL	FarmPRO II	Alliance	13/14	400	1570
15228731	420/85 R 38	144 D	TL	Agri Star II	Alliance	15/13/14	443	1679
15726390	420/85 R 38	144 A8/144 B	TL	Agrimax RT 855	BKT	15/13/14	438	1679
15726389	IF 420/85 R 38	155 D	TL	Agrimax Force	BKT	14/15	419	1670
10000525	420/85 R 38	149 D/146 E	TL	VX-Tractor	Bridgestone	15/14	448	1685

¹ = empfohlene Felge / weitere zulässige Felgenbreiten

Alles auf einen Blick:

statischer Halbmesser in mm	Abrollumfang in mm	Tragfähigkeit in kg	km/h	Luftdruck in bar
680	4480	2500/2300	40/65	3,60
681	4432	2575	65	2,40
697	4510	2500	40/50	4,00
700	4550	3750/2500	10/65	4,00
691	4410	2725/2500	40/65	4,00
714	4581	2725	65	3,60
700	4580	2725	40/50	3,60
697	4496	3450	40/50	4,00
701	4580	2725	40/50	3,60
690	4605	1850/1700	40/50	1,60
727	4703	2060	65	1,60
712	4668	2060	40/50	1,60
697	4659	2060/1900	65/70	1,60
714	4661	2060/1900	40/50	1,60
722	4705	1800/1650	40/50	1,60
719	4685	2060	40/50	1,60
719	4685	3150	40/50	1,60
710	4665	2060/1900	40/50	1,60
730	4680	2060	40/50	1,60
738	4821	2650	65	2,40
738	4821	3550	65	4,00
725	4710	3750	65	2,40
721	4788	3750	65	2,40
725	4793	3250	65	2,40
729	4755	2650/2430	40/65	2,40
711	4851	3250	40/50	1,60
730	4790	2650	40/50	2,40
724	4765	2650	40/50	2,40
735	4820	2650	40/50	2,40
736	4842	2430	40/50	1,60
730	4830	4625	65	3,20
730	4900	2800	40/50	2,40
767	5018	3750	65	2,40
755	5190	3750	40/50	1,60
724	4695	2120/1950	40/50	1,60
731	4726	2120	40/50	1,60
773	4984	2800	65	1,60
763	5014	2800	40/50	1,60
810	5017	3875	65	2,40
776	5048	3250/3000	65/70	2,40



Alliance 350



Alliance Agriflex 354 / Agriflex 354+



Alliance Power Drive 356

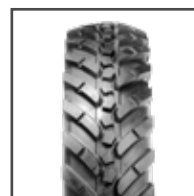

Alliance Agriflex 363+

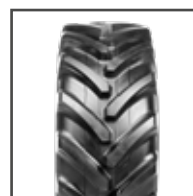

Alliance Agri Star II



Alliance FarmPRO II



BKT Agrimax Force



BKT Agrimax RT 855

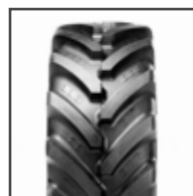

BKT Agrimax RT 955

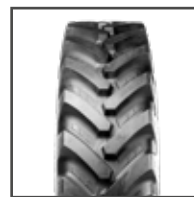

BKT Agrimax Spargo

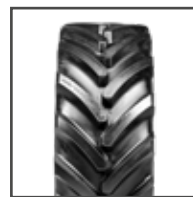

Bridgestone VX-Tractor

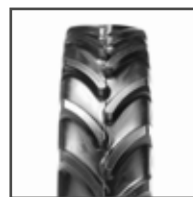

Firestone Performer 85

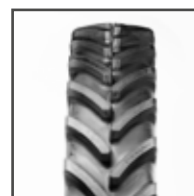

Firestone Performer 95



Kleber Cropker



Kleber Traker



Michelin AgriBib



Michelin AgriBib RC



Michelin YieldBib



Mitas AC 85



Trelleborg TM600



Vredestein TRAXION 85



AS Reifen Radial

Preise und Bestände finden Sie unter www.bohnenkamp.de/shop



TL/
TT



Artikel-Nr.	Größe	Last-/ Speed-Index	TL/TT	Profil	Marke	Felge ¹	Breite in mm	Außen ø in mm
10626426	420/85 R 38	144 D/141 E	TL	Performer 85	Firestone	15/14	447	1681
12426590	420/85 R 38	144 A8/141 B	TL	Traker	Kleber	15/14	445	1665
10928130	420/85 R 38	144 A8/144 B	TL	AC 85	Mitas	15/13/14	469	1696
13626595	420/85 R 38	144 A8/141 B	TL	TM600	Trelleborg	15/14	438	1679
14826408	420/85 R 38	144 A8/144 B	TL	TRAXION 85	Vredestein	15/14	455	1670
15228890	480/70 R 38	145 D	TL	Agri Star II	Alliance	15/14/16	482	1681
15726919	480/70 R 38	145 D	TL	Agrimax RT 765	BKT	15/14/16	479	1681
10000923	480/70 R 38	148 A8/145 D	TL	Agrimax Factor	BKT	15/14/16	479	1681
10000527	480/70 R 38	151 D/148 E	TL	VX-Tractor	Bridgestone	15/14/16	483	1692
10626755	480/70 R 38	145 D/142 E	TL	Performer 70	Firestone	15/14/16	481	1696
12426603	480/70 R 38	145 A8/145 B	TL	Fitker	Kleber	15/14/16	492	1697
13327960	480/70 R 38	145 D	TL	OmniBib	Michelin	15/14/16	498	1694
10928125	480/70 R 38	148 A8/145 D	TL	HC 70	Mitas	15/14/16	496	1699
13626603	480/70 R 38	145 A8/145 B	TL	TM700	Trelleborg	15/14/16	468	1684
10000299	480/70 R 38	145 D	TL	TRAXION 70	Vredestein	15/14/16	485	1685
15226799	540/65 R 38	153 D	TL	Agristar 365	Alliance	16/18	540	1667
15727180	540/65 R 38	156 A8/153 D	TL	Agrimax RT 657	BKT	16/18	530	1667
15727181	540/65 R 38	153 D/150 E	TL	Agrimax Sirio	BKT	16/18	530	1667
15727178	VF 540/65 R 38 NRO	162 D	TL	Agrimax V-Flecto	BKT	20/18	549	1676
10000530	540/65 R 38	153 D/150 E	TL	VX-Tractor	Bridgestone	16/18	523	1671
10627212	540/65 R 38	147 D/144 E	TL	Maxi Traction 65	Firestone	16/18	522	1677
12427100	540/65 R 38	147 D	TL	Gripker	Kleber	16/18	517	1677
13327660	540/65 R 38	147 D	TL	MultiBib	Michelin	16/18	529	1675
10928170	540/65 R 38	150 A8/147 D	TL	AC 65	Mitas	16/15/18	517	1678
13626623	540/65 R 38	147 D	TL	TM800	Trelleborg	16/15/18	530	1667
13626624	540/65 R 38	153 D/150 E	TL	TM800HS	Trelleborg	16/15/18	516	1709
14825815	540/65 R 38	147 D	TL	TRAXION 65	Vredestein	16/16/18	545	1685
10001576	VF 600/60 R 38	168 D	TL	Agriflex 372+	Alliance	20/21/18	587	1685
15727184	VF 600/60 R 38 NRO	166 D	TL	Agrimax V-Flecto	BKT	20/18	587	1685
13327850	VF 600/60 R 38	151 D	TL	XeoBib	Michelin	20	586	1698
13627435	VF 600/60 R 38	168 D/165 E	TL	TM1060	Trelleborg	20/18	605	1683
15228741	460/85 R 38	149 D	TL	Agri Star II	Alliance	16/14/15	480	1747
15228745	460/85 R 38	167 D	TL	Agri Star II	Alliance	16/14/15	480	1747
15726400	460/85 R 38	149 A8/149 B	TL	Agrimax RT 855	BKT	16/14/15	475	1747
10000526	460/85 R 38	154 D/151 E	TL	VX-Tractor	Bridgestone	16/15	486	1753
10626436	460/85 R 38	149 D/146 E	TL	Performer 85	Firestone	16/15	496	1761
12426610	460/85 R 38	149 A8/146 B	TL	Traker	Kleber	16/15	488	1754
13326617	18.4 R 38	151 A8/148 B	TL	AgriBib	Michelin	16/15	494	1770
10928180	460/85 R 38	149 A8/149 B	TL	AC 85	Mitas	16/14/15	508	1768
13626615	460/85 R 38	149 A8/146 B	TL	TM600	Trelleborg	15/16	475	1747
14826410	460/85 R 38	149 A8/149 B	TL	TRAXION 85	Vredestein	16/14/15	490	1750

¹ = empfohlene Felge / weitere zulässige Felgenbreiten

Alles auf einen Blick:

statischer Halbmesser in mm	Abrollumfang in mm	Tragfähigkeit in kg	km/h	Luftdruck in bar
758	5043	2800/2575	65/70	1,60
748	4947	2800/2575	40/50	1,60
772	5088	2800	40/50	1,60
760	5060	2800/2575	40/50	1,60
780	5035	2800	40/50	1,60
777	4984	2900	65	1,50
764	5055	2900	65	1,60
758	5000	3150/2900	40/65	1,60
766	5050	3450/3150	65/70	2,40
764	5088	2900/2650	65/70	1,60
765	5045	2900	40/50	1,60
759	5030	2900	65	1,60
768	5082	3150/2900	40/65	1,60
760	5055	2900	40/50	1,60
765	5015	2900	65	1,60
770	4926	3650	65	2,40
760	5059	4000/3650	40/65	2,40
769	5050	3650/3350	65/70	2,40
760	4981	4750	65	2,00
757	4990	3650/3350	65/70	2,40
743	5028	3075/2800	65/70	1,60
741	4963	3075	65	1,60
745	4965	3075	65	1,60
760	5023	3350/3075	40/65	1,60
760	5010	3075	65	1,60
760	5181	3650/3350	65/70	2,40
790	5080	3075	65	1,60
763	4996	5600	65	2,40
757	5044	5300	65	2,00
749	5023	3450	65	1,00
746	5050	5600/5150	65/70	2,40
802	5168	3250	65	1,60
802	5168	5450	65	4,40
785	5205	3250	40/50	1,60
809	5252	3750/3450	65/70	2,40
793	5283	3250/3000	65/70	1,60
786	5208	3250/3000	40/50	1,60
801	5267	3450/3150	40/50	1,60
805	5280	3250	40/50	1,60
800	5260	3250/3000	40/50	1,60
815	5205	3250	40/50	1,60

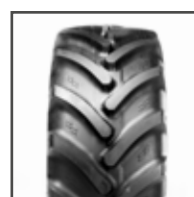

Alliance Agristar 365

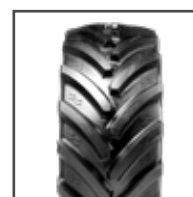

Alliance Agriflex 372+

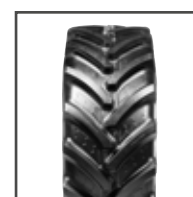

BKT Agrimax Factor

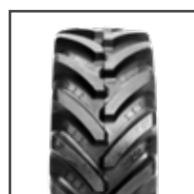

BKT Agrimax RT 657



BKT Agrimax RT 765

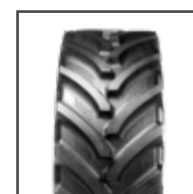

BKT Agrimax Sirio

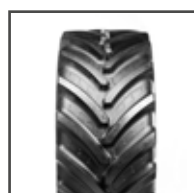

BKT Agrimax V-Flecto



Firestone
Maxi Traction 65

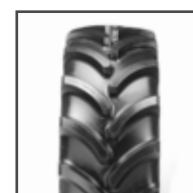

Firestone
Performer 70



Kleber Fitker



Kleber Gripker

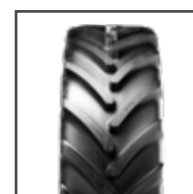

Michelin MultiBib

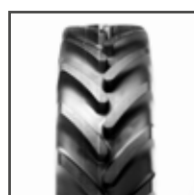

Michelin OmniBib

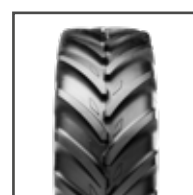

Michelin XeoBib



Mitas AC 65



Mitas HC 70



Trelleborg TM700

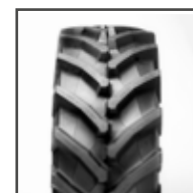

Trelleborg TM800 /
TM800HS



Trelleborg TM1060



Vredestein
TRAXION 65

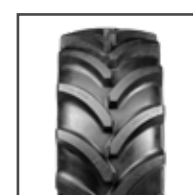

Vredestein
TRAXION 70



AS Reifen Radial

Preise und Bestände finden Sie unter www.bohnenkamp.de/shop



Artikel-Nr.	Größe	Last-/ Speed-Index	TL/TT	Profil	Marke	Felge ¹	Breite in mm	Außen ø in mm
15726403	480/80 R 38	149 A8/149 B	TL	Agrimax RT 855	BKT	16/14/15	475	1747
15727175	VF 480/80 R 38	166 D	TL	Agrimax V-Flecto	BKT	16	479	1733
15228900	520/70 R 38	150 D	TL	Agri Star II	Alliance	16/15/18	520	1750
15726929	520/70 R 38	150 D	TL	Agrimax RT 765	BKT	16/15/18	516	1749
10000966	520/70 R 38	153 A8/150 D	TL	Agrimax Factor	BKT	16/15/18	516	1749
10000528	520/70 R 38	155 D/152 E	TL	VX-Tractor	Bridgestone	16/18	521	1746
10626765	520/70 R 38	150 D/147 E	TL	Performer 70	Firestone	16/15/18	523	1777
12426615	520/70 R 38	150 A8/150 B	TL	Fitker	Kleber	16/15/18	536	1765
17427430	520/70 R 38	160 D/157 E	TL	Ground King	Nokian	16/18	520	1749
13327965	520/70 R 38	150 D	TL	OmniBib	Michelin	16/15/18	539	1766
13626617	520/70 R 38	150 D	TL	TM700	Trelleborg	16/15/18	525	1755
10928140	520/70 R 38	150 A8/150 B	TL	AC 70 G	Mitas	16/15/18	530	1747
10928150	520/70 R 38	150 A8/150 B	TL	AC 70 T	Mitas	16/15/18	517	1752
10928135	520/70 R 38	153 A8/150 D	TL	HC 70	Mitas	16/15/18	536	1751
13626622	520/70 R 38	150 D	TL	TM700	Trelleborg	16/15/18	520	1740
10000295	520/70 R 38	150 D	TL	TRAXION 70	Vredestein	16/15/18	520	1750
15226788	600/65 R 38	162 A8/159 D	TL	Agristar 365	Alliance	20/18	594	1745
15727185	600/65 R 38	162 A8/159 D	TL	Agrimax RT 657	BKT	20/18	611	1745
10000532	600/65 R 38	157 D/154 E	TL	VX-Tractor	Bridgestone	20/18	584	1644
10629074	VF 600/65 R 38	164 D/160 E	TL	VT Tractor	Bridgestone	21/20/18	597	1731
10627222	600/65 R 38	153 D/150 E	TL	Maxi Traction 65	Firestone	18/20	584	1737
12427110	600/65 R 38	153 D	TL	Gripker	Kleber	20/18	591	1748
13327670	600/65 R 38	153 D	TL	MultiBib	Michelin	20/18	595	1768
10928190	600/65 R 38	156 A8/153 D	TL	AC 65	Mitas	16/18	590	1759
17427435	600/65 R 38	165 D/161 E	TL	Ground King	Nokian	20/18	600	1745
13626625	600/65 R 38	153 D	TL	TM800	Trelleborg	18/20	590	1745
14825820	600/65 R 38	153 D	TL	TRAXION 65	Vredestein	18/20	590	1750
10001573	VF 650/60 R 38	173 D	TL	Agriflex 372+	Alliance	23/21	650	1745
15727198	VF 650/60 R 38	173 D	TL	Agrimax V-Flecto	BKT	23/20/21	650	1745
13327840	VF 650/60 R 38	155 D	TL	XeoBib	Michelin	23	677	1735
13328079	VF 650/60 R 38	170 D/167 E	TL	AxioBib 2	Michelin	23/20	668	1742
13627450	VF 650/60 R 38	166 D	TL	TM1060	Trelleborg	23/20	655	1735
10001394	VF 650/60 R 38	170 D	TL	TRAXION OPTIMALL	Vredestein	23/20	665	1745
15727183	VF 710/55 R 38	175 D	TL	Agrimax V-Flecto	BKT	25/24	710	1750
15228781	520/85 R 38	155 D	TL	Agri Star II	Alliance	16/18	520	1850
15225220	IF 520/85 R 38	167 D	TL	Agriflex 372	Alliance	16/18	540	1850
15228785	520/85 R 38	169 D	TL	Agri Star II	Alliance	16/18	520	1850
15726410	520/85 R 38	155 A8/155 B	TL	Agrimax RT 855	BKT	16/18	516	1849
15726412	520/85 R 38	170 A8/170 B	TL	Agrimax RT 855	BKT	16/18	516	1849
10000529	520/85 R 38	160 D/157 E	TL	VX-Tractor	Bridgestone	18/16	550	1846
10626446	520/85 R 38	155 D/152 E	TL	Performer 85	Firestone	18/16	562	1851

¹ = empfohlene Felge / weitere zulässige Felgenbreiten

Alles auf einen Blick:

statischer Halbmesser in mm	Abrollumfang in mm	Tragfähigkeit in kg	km/h	Luftdruck in bar
785	5161	3250	40/50	1,60
774	5169	5300	65	2,40
786	5175	3350	65	1,60
793	5300	3350	65	1,60
795	5239	3650/3350	40/65	1,60
788	5211	3875/3550	65/70	2,40
801	5331	3350/3075	65/70	1,60
783	5228	3350	40/50	1,60
803	5342	4500/4125	65/70	3,20
782	5229	3350	65	1,60
790	5255	3350	65	1,60
782	5230	3350	40/50	1,60
788	5187	3350	40/50	1,60
790	5232	3650/3350	40/65	1,60
774	5150	3350	65	1,60
790	5165	3350	65	1,60
782	5284	4750/4375	40/65	2,40
790	5247	4750/4375	40/65	2,40
730	4923	4125/3750	65/70	2,40
753	5139	5000/4500	65/70	1,60
780	5214	3650/3350	65/70	1,60
768	5167	3650	65	1,60
779	5229	3650	65	1,60
792	5251	4000/3650	40/65	1,60
798	5321	5150/4625	65/70	3,20
785	5210	3650	65	1,60
810	5210	3650	65	1,60
780	5128	6500	65	2,40
774	5217	6500	65	2,40
749	5108	3875	65	1,00
772	5157	6000/5450	65/70	2,00
755	5190	5300	65	1,60
770	5150	6000	65	2,00
780	5242	6900	65	2,40
838	5537	3875	65	1,60
834	5482	5450	65	2,40
838	5537	5800	65	3,60
813	5466	3875	40/50	1,60
847	5595	6000	40/50	3,60
851	5530	4500/4125	65/70	2,40
829	5553	3875/3550	65/70	1,60

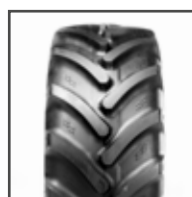

Alliance Agristar 365

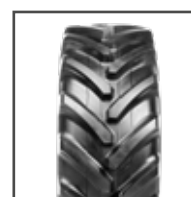

Alliance Agri Star II

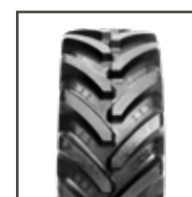

BKT Agrimax RT 657



BKT Agrimax RT 765



BKT Agrimax RT 855

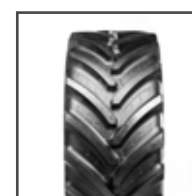

BKT Agrimax V-Flecto



Bridgestone
VT Tractor



Bridgestone
VX-Tractor

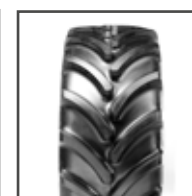

Firestone
Maxi Traction 65

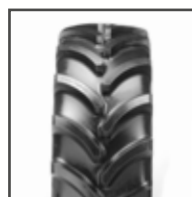

Firestone
Performer 70

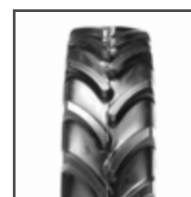

Firestone
Performer 85



Kleber Fitker

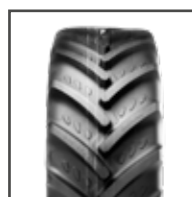

Kleber Gripker

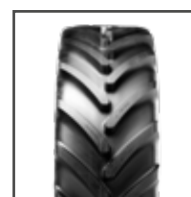

Michelin MultiBib

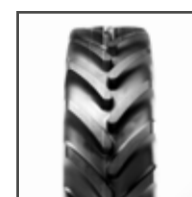

Michelin OmniBib

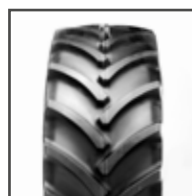

Mitas AC 65



Nokian Ground King



Trelleborg TM700

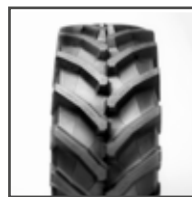

Trelleborg TM800



Vredestein
TRAXION 65

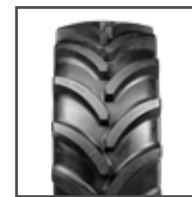

Vredestein
TRAXION 70



AS Reifen Radial





Preise und Bestände finden Sie unter www.bohnenkamp.de/shop



Artikel-Nr.	Größe	Last-/ Speed-Index	TL/TT	Profil	Marke	Felge ¹	Breite in mm	Außen ø in mm
12426870	520/85 R 38	155 A8/152 B	TL	Traker	Kleber	18/16	541	1838
13326635	520/85 R 38	160 A8/160 B	TL	AgriBib 2	Michelin	16/18	516	1849
10928185	520/85 R 38	155 A8/155 B	TL	AC 85	Mitas	16/18	545	1857
13626630	520/85 R 38	155 A8/152 B	TL	TM600	Trelleborg	18/16	536	1849
14826409	520/85 R 38	155 A8/155 B	TL	TRAXION 85	Vredestein	18/16	555	1830
15228910	580/70 R 38	155 D	TL	Agri Star II	Alliance	18	580	1827
15228912	580/70 R 38	180 D	TL	Agri Star II	Alliance	18	580	1827
15726941	580/70 R 38	155 D	TL	Agrimax RT 765	BKT	18/20	577	1827
10000924	580/70 R 38	158 A8/155 D	TL	Agrimax Factor	BKT	18	577	1827
15726945	580/70 R 38	180 A8/180 B	TL	Agrimax RT 765	BKT	18	577	1827
10000531	580/70 R 38	160 D/157 E	TL	VX-Tractor	Bridgestone	18	585	1812
10626775	580/70 R 38	155 D/152 E	TL	Performer 70	Firestone	18	576	1846
12426650	580/70 R 38	155 A8/155 B	TL	Fitker	Kleber	18	606	1849
17427434	580/70 R 38	166 D/163 E	TL	Ground King	Nokian	18	580	1829
13327970	580/70 R 38	155 D	TL	OmniBib	Michelin	18	601	1836
10928160	580/70 R 38	158 A8/155 D	TL	HC 70	Mitas	18	596	1857
13626642	580/70 R 38	155 D	TL	TM700	Trelleborg	18	584	1825
10000296	580/70 R 38	155 D	TL	TRAXION 70	Vredestein	18	595	1825
15226794	650/65 R 38	178 A8/175 B	TL	360	Alliance	20	645	1835
15226812	650/65 R 38	174 A8/171 D	TL	Agristar 365	Alliance	20/18	658	1825
15727192	650/65 R 38	160 A8/157 D	TL	Agrimax RT 600	BKT	20	645	1811
15727190	650/65 R 38	166 A8/163 D	TL	Agrimax RT 657	BKT	20/18	645	1811
15727189	VF 650/65 R 38 NRO	169 D	TL	Agrimax V-Flecto	BKT	23/20/21	650	1811
15727187	IF 650/65 R 38	169 D	TL	Agrimax Force	BKT	23	650	1830
10000533	650/65 R 38	163 D/159 E	TL	VX-Tractor	Bridgestone	20	647	1813
10629076	VF 650/65 R 38 NRO	169 D/166 E	TL	VT Tractor	Bridgestone	23/20/21	650	1801
10627232	650/65 R 38	157 D/154 E	TL	Maxi Traction 65	Firestone	20	636	1807
12427120	650/65 R 38	157 D	TL	Gripker	Kleber	20	651	1805
13327680	650/65 R 38	157 D	TL	MultiBib	Michelin	20	646	1819
13327072	IF 650/65 R 38	169 D	TL	AxioBib	Michelin	23/21	649	1826
10928200	650/65 R 38	160 A8/157 D	TL	AC 65	Mitas	18/20	618	1828
10928195	650/65 R 38	160 A8/157 D	TL	SFT	Mitas	18/20	645	1828
17427432	650/65 R 38	169 D/166 E	TL	Ground King	Nokian	20	645	1811
13626645	650/65 R 38	157 D	TL	TM800	Trelleborg	20/18	645	1811
13626665	650/65 R 38	163 D/159 E	TL	TM800HS	Trelleborg	20/18	645	1811
10000972	VF 650/65 R 38	172 D/169 E	TL	TM1000PT	Trelleborg	23/21	670	1830
14825825	650/65 R 38	157 D	TL	TRAXION 65	Vredestein	20/18	650	1840
10001393	VF 650/65 R 38 NRO	169 D	TL	TRAXION OPTIMALL	Vredestein	23/20	665	1835
15726948	620/70 R 38	170 D	TL	Agrimax RT 765	BKT	20/18	625	1833
15225249	VF 710/60 R 38	160 D	TL	AgriFlex 372+	Alliance	25	710	1815

¹ = empfohlene Felge / weitere zulässige Felgenbreiten

Alles auf einen Blick:

				
statischer Halbmesser in mm	Abrollumfang in mm	Tragfähigkeit in kg	km/h	Luftdruck in bar
820	5452	3875/3550	40/50	1,60
831	5493	4500	40/50	2,40
827	5515	3875	40/50	1,60
825	5510	3875/3550	40/50	1,60
850	5465	3875	40/50	1,60
830	5435	3875	65	1,60
847	5435	8000	65	5,50
821	5505	3875	65	1,60
823	5456	4250/3875	40/65	1,60
821	5505	8000	40/50	4,60
819	5408	4500/4125	65/70	2,40
830	5538	3875/3550	65/70	1,60
821	5478	3875	40/50	1,60
835	5574	5300/4875	65/70	3,20
815	5440	3875	65	1,60
822	5500	4250/3875	40/65	1,60
822	5380	3875	65	1,60
820	5385	3875	65	1,60
830	5500	7500/6900	40/50	3,50
826	5505	6700/6150	40/65	3,60
833	5443	4500/4125	40/65	1,60
830	5483	5300/4875	40/65	2,40
798	5387	5800	65	1,60
830	5510	5800	65	2,40
831	5413	4875/4375	65/70	2,40
779	5424	5800/5300	65/70	1,60
811	5421	4125/3750	65/70	1,60
794	5336	4125	65	1,60
801	5380	4125	65	1,60
833	5446	5800	65	2,40
810	5416	4500/4125	40/65	1,60
810	5445	4500/4125	40/65	1,60
827	5540	5800/5300	65/70	3,20
815	5395	4125	65	1,60
815	5450	4875/4375	65/70	2,40
800	5480	6300/5800	65/70	2,00
840	5475	4125	65	1,60
800	5400	5800	65	2,00
828	5591	6000	65	3,20
803	5314	4500	65	1,00

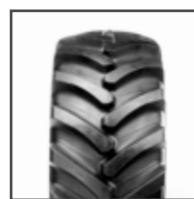

Alliance 360



Alliance Agristar 365

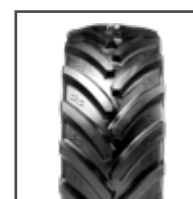

Alliance Agriflex 372+

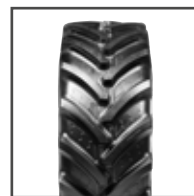

BKT Agrimax Factor

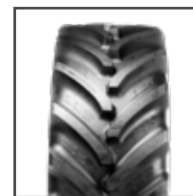

BKT Agrimax Force

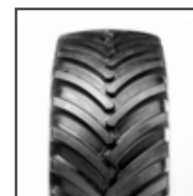

BKT Agrimax RT 600

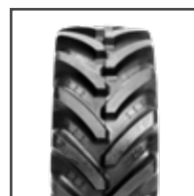

BKT Agrimax RT 657

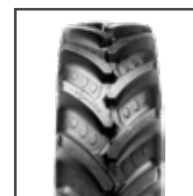

BKT Agrimax RT 765



Kleber Traker



Michelin AgriBib 2

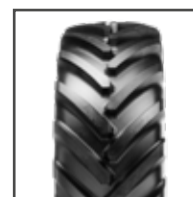

Michelin AxioBib

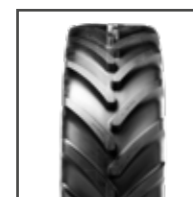

Michelin MultiBib

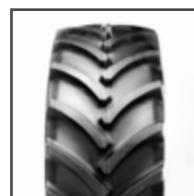

Mitas AC 65

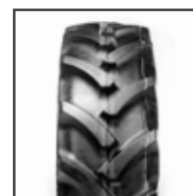

Mitas AC 85



Mitas HC 70



Mitas SFT



Trelleborg TM600



Trelleborg TM800 /
TM800HS



Trelleborg
TM1000PT



Vredestein
TRAXION 65



Vredestein
TRAXION OPTIMALL







AS Reifen Radial

Preise und Bestände finden Sie unter www.bohnenkamp.de/shop

Artikel-Nr.	Größe	Last-/ Speed-Index	TL/ TT	Profil	Marke	Felge ¹	Breite in mm	Außen ø in mm
15727194	IF 710/60 R 38	172 D	TL	Agrimax Force	BKT	25	708	1817
15727196	VF 710/60 R 38 NRO	171 D	TL	Agrimax V-Flecto	BKT	25/23	708	1820
13327074	IF 710/60 R 38	172 D	TL	AxioBib	Michelin	25	710	1844
13327860	VF 710/60 R 38	160 D	TL	XeoBib	Michelin	25	712	1814
10000027	VF 710/60 R 38	174 D/171 E	TL	TM1000PT	Trelleborg	25	710	1840
13627460	VF 710/60 R 38	171 D	TL	TM1060	Trelleborg	25/23	715	1820
10001396	VF 710/60 R 38	174 D	TL	TRAXION OPTIMALL	Vredestein	25/23	720	1840
15225239	650/75 R 38	169 D	TL	Agristar 378 XL	Alliance	23	671	1930
15726946	650/75 R 38	169 D	TL	Agrimax RT 765	BKT	21/20/23	655	1941
10000534	650/75 R 38	169 D/166 E	TL	VX-Tractor	Bridgestone	21/20/23	678	1953
10000550	VF 650/75 R 38	175 D/172 E	TL	VT Tractor	Bridgestone	23/20/21	661	1941
10626540	650/75 R 38	169 D/166 E	TL	Maxi Traction	Firestone	21/20/23	678	1953
13327057	650/75 R 38	169 D/165 E	TL	MachXBib	Michelin	23	709	1948
10928085	650/75 R 38	172 A8/169 D	TL	SFT	Mitas	20/21/23	657	1944
13626640	650/75 R 38	169 D/166 E	TL	TM900HP	Trelleborg	23	676	1940
14826075	650/75 R 38	169 D	TL	TRAXION XXL	Vredestein	23/20/21	695	1935
15228915	710/70 R 38	172 D	TL	Agri Star II	Alliance	23/25	720	1959
15228245	710/70 R 38	178 D	TL	Agri Star II	Alliance	23/25	720	1959
15225248	VF 710/70 R 38 CFO	178 D	TL	Agriflex 372+	Alliance	25/23/24	720	1959
15726961	710/70 R 38	166 D	TL	Agrimax RT 765M	BKT	23/25	716	1959
15726951	710/70 R 38	171 D/168 E	TL	Agrimax Sirio	BKT	23/25	716	1959
15726959	710/70 R 38	178 A8/175 D	TL	Agrimax RT 765M	BKT	23/25	716	1959
15727197	710/70 R 38	181 A8/178 D	TL	Agrimax RT 600	BKT	23/25	706	1959
15726958	VF 710/70 R 38	181 D	TL	Agrimax V-Flecto	BKT	24/23/25	715	1961
10001515	710/70 R 38	178 A8 / 175 D	TL	Agrimax Factor	BKT	23/25	16	1959
10000536	710/70 R 38	171 D/168 E	TL	VX-Tractor	Bridgestone	23/25	731	1970
10629080	VF 710/70 R 38	178 D/175 E	TL	VT Tractor	Bridgestone	25/23	715	1949
10626781	710/70 R 38	171 D/168 E	TL	Maxi Traction	Firestone	23	731	1970
13326640	710/70 R 38	171 D	TL	MachXBib	Michelin	23/25	713	1973
10928155	710/70 R 38	169 A8/166 D	TL	AC 65	Mitas	23/25	708	1925
10928145	710/70 R 38	169 A8/166 D	TL	SFT	Mitas	23	736	1958
17427438	710/70 R 38	177 D/174 E	TL	Ground King	Nokian	23	710	1953
13626637	710/70 R 38	166 D	TL	TM800	Trelleborg	23	716	1959
13626636	710/70 R 38	171 D/168 E	TL	TM800HS	Trelleborg	23/25	711	1973
14826090	710/70 R 38	166 D	TL	TRAXION XXL	Vredestein	23/25	730	1930
14826101	710/70 R 38	171 D	TL	TRAXION XXL	Vredestein	23/25	730	1930
10001397	VF 710/70 R 38	181 D	TL	TRAXION OPTIMALL	Vredestein	25/23	730	1945
15727199	VF 710/75 R 38	183 D	TL	Agrimax V-Flecto	BKT	24/23/25	720	2060
14826105	710/75 R 38	174 D	TL	TRAXION XXL	Vredestein	23/25	715	2000
15228805	650/85 R 38	173 D	TL	Agri Star II	Alliance	23/20/21	680	2072

¹ = empfohlene Felge / weitere zulässige Felgenbreiten

Alles auf einen Blick:

				
statischer Halbmesser in mm	Abrollumfang in mm	Tragfähigkeit in kg	km/h	Luftdruck in bar
812	5462	6300	65	2,40
794	5447	6150	65	1,60
834	5486	6300	65	2,40
794	5356	4500	65	1,00
805	5505	6700/6150	65/70	2,00
785	5420	6150	65	1,60
810	5450	6700	65	2,00
871	5730	5800	65	2,40
874	5820	5800	65	2,40
883	5885	5800/5300	65/70	2,40
828	5758	6900/6300	65/70	1,60
883	5885	5800/5300	65/70	2,40
871	5786	5800/5150	65/70	2,40
872	5795	6300/5800	40/65	2,40
855	5840	5800/5300	65/70	2,40
890	5775	5800	65	2,40
839	5781	6300	65	2,40
885	5781	7500	65	3,40
843	5717	7500	65	1,60
859	5751	5300	65	1,60
887	5840	6150/5600	65/70	2,40
859	5751	7500/6900	40/65	3,20
881	5926	8250/7500	40/65	3,20
843	5773	8250	65	2,00
		7500/6900	40/65	3,20
888	5910	6150/5600	65/70	2,40
825	5749	7500/6900	65/70	1,60
888	5910	6150/5600	65/70	2,40
871	5804	6150	65	2,40
857	5716	5800/5300	40/65	1,60
870	5780	5800/5300	40/65	1,60
884	5934	7300/6700	65/70	3,20
884	5765	5300	65	1,60
884	5928	6150/5600	65/70	2,40
870	5760	5300	65	1,60
870	5710	6150	65	2,40
840	5760	8250	65	2,00
905	6151	8750	65	2,00
910	5950	6700	65	2,40
954	6201	6500	65	2,40

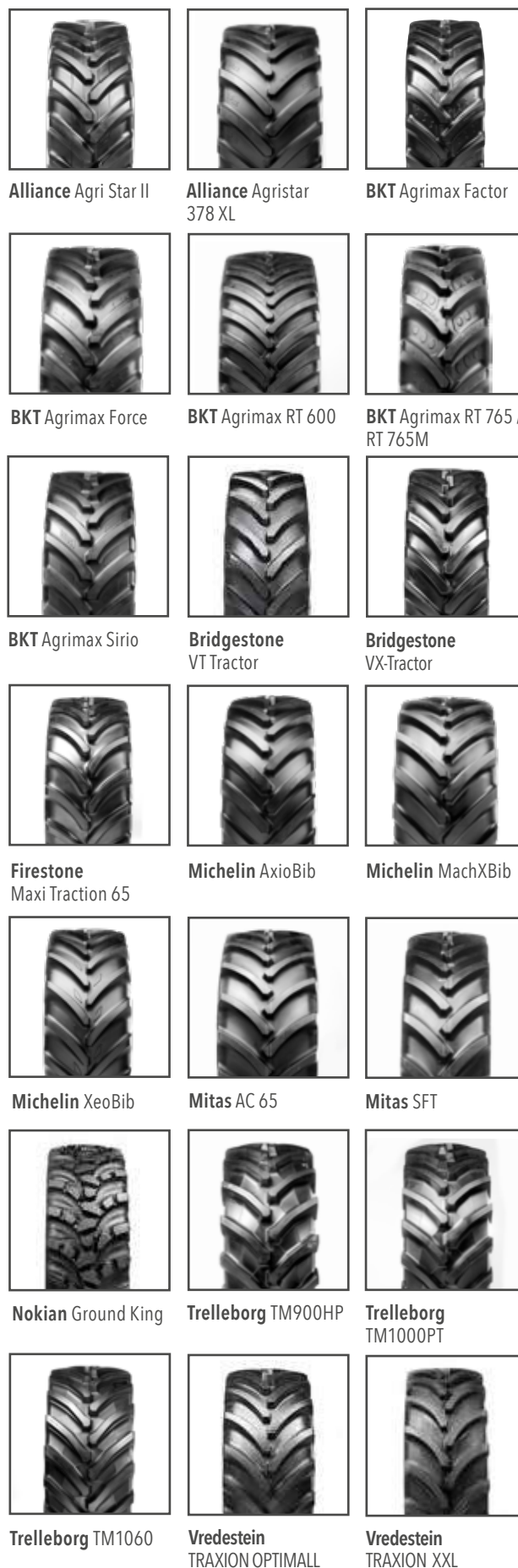

Alliance Agri Star II	Alliance Agristar 378 XL	BKT Agrimax Factor
BKT Agrimax Force	BKT Agrimax RT 600	BKT Agrimax RT 765 / RT 765M
BKT Agrimax Sirio	Bridgestone VT Tractor	Bridgestone VX-Tractor
Firestone Maxi Traction 65	Michelin AxioBib	Michelin MachXBib
Michelin XeoBib	Mitas AC 65	Mitas SFT
Nokian Ground King	Trelleborg TM900HP	Trelleborg TM1000PT
Trelleborg TM1060	Vredestein TRAXION OPTIMALL	Vredestein TRAXION XXL



AS Reifen Radial





Preise und Bestände finden Sie unter www.bohnenkamp.de/shop



Artikel-Nr.	Größe	Last-/ Speed-Index	TL/TT	Profil	Marke	Felge ¹	Breite in mm	Außen ø in mm
15726415	650/85 R 38	176 A8/173 D	TL	Agrimax Fortis	BKT	23/20/21	675	2071
15726414	IF 650/85 R 38 CFO	179 D	TL	Agrimax Force	BKT	23	663	2071
10000535	650/85 R 38	173 D/170 E	TL	VX-Tractor	Bridgestone	23	701	2078
10629078	VF 650/85 R 38	179 D/176 E	TL	VT Tractor	Bridgestone	23/20/21	663	2071
10626451	650/85 R 38	173 D/170 E	TL	Maxi Traction	Firestone	23	701	2078
13327050	650/85 R 38	173 A8/173 B	TL	MachXBib	Michelin	23/20	686	2063
13328056	VF 650/85 R 38	182 D/179 E	TL	AxioBib 2	Michelin	23/20/21	680	2063
10928090	650/85 R 38	176 A8/173 D	TL	SFT	Mitas	23/20/21	720	2070
17427440	650/85 R 38	178 D/175 E	TL	Ground King	Nokian	23/20/21	650	2066
13626646	650/85 R 38	173 D/170 E	TL	TM900HP	Trelleborg	23	709	2070
10000987	VF 650/85 R 38	182 D/179 E	TL	TM1000PT	Trelleborg	23/21	680	2085
14826080	650/85 R 38	173 D	TL	TRAXION XXL	Vredestein	23/20/21	720	2065
10000991	IF 680/80 R 38 CHO	182 A8	TL	CerexBib 2	Michelin	21/23	646	2020
10928092	680/80 R 38 CHO	182 A8/179 D	TL	SFT	Mitas	21/20/23	650	2050
10000899	800/70 R 38	173 D	TL	Agri Star II	Alliance	27	823	2085
15225252	IF 800/70 R 38 CFO	187 A8/183 B	TL	Agriflex 372	Alliance	27/25	820	2085
15726960	800/70 R 38	181 A8/178 D	TL	Agrimax Fortis	BKT	25/23/27	798	2085
15726962	IF 800/70 R 38 CFO	184 D	TL	Agrimax Force	BKT	27/25	794	2085
10001637	VF 800/70 R 38 CFO	187 D	TL	Agrimax V-Flecto	BKT	28/25/27/30	804	2085
10000563	IF 800/70 R 38	184 A8	TL	VT Combine	Bridgestone	27	787	2053
10629082	VF 800/70 R 38	184 D/181 E	TL	VT Tractor	Bridgestone	27/25	794	2060
10626791	IF 800/70 R 38	184 D/181 E	TL	Maxi Traction	Firestone	27	825	2080
13327064	800/70 R 38	173 D	TL	MachXBib	Michelin	25/27	809	2066
10928205	800/70 R 38	181 A8/178 D	TL	SFT	Mitas	25/27	765	2052
10928215	800/70 R 38 CHO	181 A8/178 D	TL	SFT	Mitas	25/27	766	2042
13626667	800/70 R 38	178 D/175 E	TL	TM900HP	Trelleborg	25/27	810	2065
14826110	800/70 R 38	178 D	TL	TRAXION XXL	Vredestein	25/27	825	2065
14827125	VF 800/70 R 38	187 D	TL	TRAXION OPTIMALL	Vredestein	27/25	800	2060
10000901	900/55 R 38	181 A8/179 D	TL	Agrimax RT 657	BKT	27/30	880	1950
15225254	IF 900/60 R 38 CFO	184 A8	TL	Agriflex 372	Alliance	30/31	862	2040
15727195	IF 900/60 R 38 CFO	184 D	TL	Agrimax Force	BKT	30/31	916	2045
10629084	VF 900/60 R 38 NRO	183 D/180 E	TL	VT Tractor	Bridgestone	30/28	851	2045
10000990	VF 900/60 R 38 NRO	193 A8	TL	CerexBib 2	Michelin	30/27	880	2027
10928106	900/60 R 38	181 A8/178 D	TL	SFT	Mitas	27/30	870	2060
10928107	900/60 R 38 CHO	184 A8/181 D	TL	SFT	Mitas	27/30	860	2055
13626650	900/60 R 38	178 D/175 E	TL	TM900HP	Trelleborg	28/27/30	905	2040
14826115	900/60 R 38	181 A8/178 D	TL	TRAXION XXL	Vredestein	27/28/30	865	2040
15227371	VF 710/85 R 38	183 D	TL	Agriflex 372+	Alliance	25	730	2165
13327055	IF 710/85 R 38	178 D	TL	AxioBib	Michelin	25	734	2159

¹ = empfohlene Felge / weitere zulässige Felgenbreiten

Alles auf einen Blick:

 statischer Halbmesser in mm	 Abrollumfang in mm	 Tragfähigkeit in kg	 km/h	 Luftdruck in bar
935	6184	7100/6500	40/65	2,40
927	6106	7750	65	2,40
940	6218	6500/6000	65/70	2,40
875	6027	7750/7100	65/70	1,60
940	6218	6500/6000	65/70	2,40
924	6092	6500	40/50	2,40
900	6088	8500/7750	65/70	2,00
920	6130	7100/6500	40/65	2,40
933	6272	7500/6900	65/70	3,20
910	6220	6500/6000	65/70	2,40
900	6225	8500/7750	65/70	2,00
930	6160	6500	65	2,40
904	6030	8500	40	2,80
895	6070	8500/7750	40/65	3,20
923	6070	6500	65	1,60
926	6144	9750/8750	40/50	2,80
912	6202	8250/7500	40/65	2,40
923	6184	9000	65	2,40
890	6155	9750	65	2,00
899	6127	9000	40	2,40
882	6094	9000/8250	65/70	1,60
924	6148	9000/8250	65/70	2,40
899	6093	6500	65	1,60
911	6090	8250/7500	40/65	2,40
916	6090	8250/7500	40/65	2,40
910	6205	7500/6900	65/70	2,40
940	6160	7500	65	2,40
895	6105	9750	65	2,00
880	5842	7750	65	2,80
897	5964	9000	40	2,40
904	6107	9000	65	2,40
876	6026	8750/8000	65/70	1,60
888	5987	11500	40	2,80
918	6115	8250/7500	40/65	2,40
918	6115	9000/8250	40/65	2,80
915	6180	7500/6900	65/70	2,40
930	6080	8250/7500	40/65	2,40
931	6330	8750	65	1,60
937	6365	7500	65	1,60



Alliance Agriflex 372

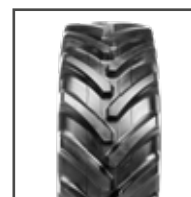

Alliance Agri Star II

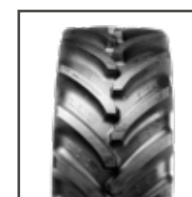

BKT Agrimax Force

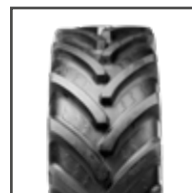

BKT Agrimax Fortis

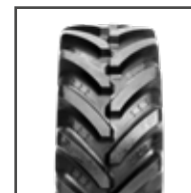

BKT Agrimax RT 657

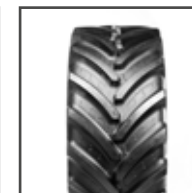

BKT Agrimax V-Flecto

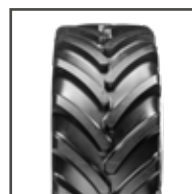

Bridgestone
VT Combine



Bridgestone
VT Tractor



Bridgestone
VX-Tractor



Firestone
Maxi Traction

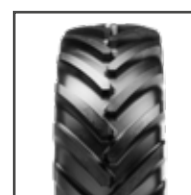

Michelin AxioBib /
AxioBib 2



Michelin CerexBib 2



Michelin MachXBib



Mitas SFT



Nokian Ground King

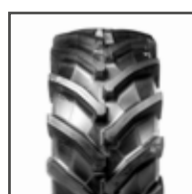

Trelleborg TM900HP



Trelleborg
TM1000PT



Vredestein
TRAXION OPTIMALL



Vredestein
TRAXION XXL



AS Reifen Radial

Preise und Bestände finden Sie unter www.bohnenkamp.de/shop



Artikel-Nr.	Größe	Last-/ Speed-Index	TL/TT	Profil	Marke	Felge ¹	Breite in mm	Außen ø in mm
15226190	9.5 R 40	135 A8/132 D	TL	350	Alliance	8/7	241	1460
15727477	230/95 R 40	132 A8/132 B	TL	Agrimax RT 955	BKT	7/8	228	1454
12426785	230/95 R 40	135 A8/132 D	TL	Cropker	Kleber	7/8	225	1448
15226205	230/95 R 42	136 A8/133 D	TL	350	Alliance	7/8	228	1505
15727480	230/95 R 42	133 A8/133 B	TL	Agrimax RT 955	BKT	8/7	238	1506
10000051	11.2 R 42	139 D/142 A8	TL	350	Alliance	10	285	1565
12426790	270/95 R 42	144 A8/141 D	TL	Cropker	Kleber	9/8/10	275	1581
15227788	320/80 R 42	141 A8/141 B	TL	FarmPRO Radial 80	Alliance	10	319	1580
10001227	VF 320/80 R 42	155 D	TL	Agriflex 354 +	Alliance	11	320	1580
15727485	300/85 R 42	144 A8/144 B	TL	Agrimax RT 955	BKT	9/10/11	295	1577
10926486	300/85 R 42	144 A8/141 B	TL	AC 90	Mitas	9/10/11	298	1574
10627323	300/95 R 42	161 A2/147 D	TL	Performer 95	Firestone	10/9/11	303	1637
12426792	300/95 R 42	150 A8/147 D	TL	Cropker	Kleber	8/9/10	300	1635
10926488	300/95 R 42	147 A8/144 B	TL	AC 90	Mitas	10/9/11	306	1617
10000150	320/90 R 42	147 D	TL	Agri Star II	Alliance	10/9/11	319	1643
15727490	320/90 R 42	139 A8/139 B	TL	Agrimax RT 945	BKT	10/9/11	319	1643
13327740	320/90 R 42	147 A8/147 B	TL	AgriBib RC	Michelin	10/9	312	1638
13326696	VF 320/90 R 42	163 D	TL	SprayBib	Michelin	11/10	332	1635
10000537	460/85 R 42	156 D/153 E	TL	VX-Tractor	Bridgestone	16/15	480	1842
10626465	460/85 R 42	150 D/147 E	TL	Performer 85	Firestone	16/15	475	1841
15227383	18.4 R 42	169 A8/166 B	TL	Power Drive 356	Alliance	16/15	467	1850
15726420	480/80 R 42	151 A8/151 B	TL	Agrimax RT 855	BKT	16	479	1835
13328218	480/80 R 42	156 A8/156 B	TL	AgriBib 2	Michelin	16	489	1840
15228791	480/80 R 42	151 D	TL	Agri Star II	Alliance	16	494	1830
15228787	480/80 R 42	169 D	TL	Agri Star II	Alliance	16	494	1830
10000875	VF 480/80 R 42	176 D/172 E	TL	SprayBib	Michelin	16	482	1843
10928225	480/80 R 42	151 A8/151 B	TL	AC 85	Mitas	16/14/15	513	1850
13626655	480/80 R 42	151 A8/151 B	TL	TM600	Trelleborg	16	495	1850
14826530	480/80 R 42	156 A8/156 B	TL	TRAXION 85	Vredestein	16	500	1850
13626648	600/65 R 42	154 D	TL	TM800	Trelleborg	18/20	590	1847
15228793	520/85 R 42	157 D	TL	Agri Star II	Alliance	16/18	520	1952
15227399	520/85 R 42	168 A8/165 D	TL	385	Alliance	18	538	1956
15228795	520/85 R 42	169 D	TL	Agri Star II	Alliance	16/18	520	1952
15227395	IF 520/85 R 42	169 D	TL	Agriflex 372	Alliance	16/18	540	1955
15726430	520/85 R 42	157 A8/157 B	TL	Agrimax RT 855	BKT	16/18	516	1951
15726432	520/85 R 42	167 A8/167 B	TL	Agrimax RT 855	BKT	16/18	516	1951
15726433	520/85 R 42	168 D	TL	Agrimax Teris	BKT	16/15/18	516	1951
10000538	520/85 R 42	162 D/159 E	TL	VX-Tractor	Bridgestone	18/16	540	1951
10626475	520/85 R 42	157 D/154 E	TL	Performer 85	Firestone	18/16	561	1946
12426648	520/85 R 42	157 A8/157 B	TL	Traker	Kleber	18/16	557	1948

¹ = empfohlene Felge / weitere zulässige Felgenbreiten

Alles auf einen Blick:

statischer Halbmesser in mm	Abrollumfang in mm	Tragfähigkeit in kg	km/h	Luftdruck in bar
686	4490	2180/2000	40/65	3,60
690	4445	2000	40/50	4,00
684	4350	2180/2000	40/65	4,00
712	4537	2240/2060	40/65	4,00
714	4633	2060	40/50	4,00
737	4832	2650/2430	40/65	3,60
745	4734	2800/2575	40/65	4,00
739	4676	2575	40/50	3,20
739	4786	3875	65	3,60
745	4850	2800	40/50	4,00
740	4715	2800/2575	40/50	4,00
774	5040	4625/3075	10/65	4,00
762	4898	3350/3075	40/65	4,00
753	4904	3075/2800	40/50	4,00
772	4989	3075	65	4,00
760	4944	2430	40/50	2,40
764	4908	3075	40/50	3,60
758	4890	4875	65	4,40
849	5517	4000/3650	65/70	2,40
832	5523	3350/3075	65/70	1,60
853	5532	5800/5300	40/50	4,50
835	5495	3450	40/50	1,60
837	5470	4000	40/50	2,40
843	5429	3450	65	1,60
843	5429	5800	65	4,40
834	5484	7100/6300	65/70	3,60
835	5540	3450	40/50	1,60
833	5550	3450	40/50	1,60
855	5600	4000	40/50	2,40
830	5580	3750	65	1,60
894	5819	4125	65	1,60
885	5780	5600/5150	40/65	2,80
909	5985	5800	65	3,60
879	5825	5800	65	2,40
858	5782	4125	40/50	1,60
858	5782	5450	40/50	3,20
890	5851	5600	65	3,20
900	5845	4750/4375	65/70	2,40
876	5838	4125/3750	65/70	1,60
867	5776	4125	40/50	1,60



Alliance 350

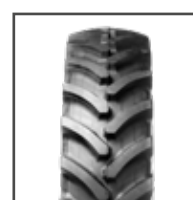

Alliance Agriflex 354+



Alliance Power Drive 356



Alliance 385



Alliance FarmPRO Radial 80



BKT Agrimax RT 855

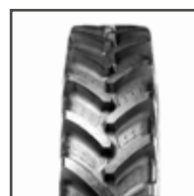

BKT Agrimax RT 945

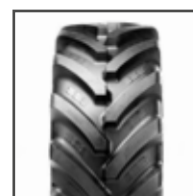

BKT Agrimax RT 955



BKT Agrimax Teris



Firestone Performer 85

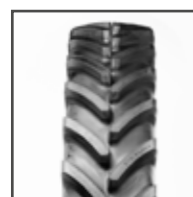

Firestone Performer 95



Kleber Cropker



Kleber Traker



Michelin AgriBib 2



Michelin AgriBib RC

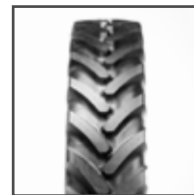

Michelin SprayBib



Mitas AC 85



Mitas AC 90



Trelleborg TM600

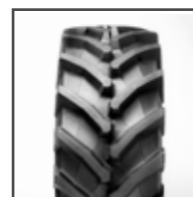

Trelleborg TM800



Vredestein TRAXION 85



AS Reifen Radial

Preise und Bestände finden Sie unter www.bohnenkamp.de/shop



Artikel-Nr.	Größe	Last-/ Speed-Index	TL/TT	Profil	Marke	Felge ¹	Breite in mm	Außen ø in mm
13326780	520/85 R 42	162 A8/162 B	TL	AgriBib 2	Michelin	18	536	1951
10000981	VF 520/85 R 42 CFO+	177 A8	TL	CerexBib 2	Michelin	18	541	1953
10928230	520/85 R 42	162 A8/162 B	TL	AC 85	Mitas	16/18	537	1966
13626660	520/85 R 42	157 A8/157 B	TL	TM600	Trelleborg	18/16	536	1952
14826460	520/85 R 42	157 A8/157 B	TL	TRAXION 85	Vredestein	18/16	555	1930
15225255	580/70 R 42	158 A8/158 B	TL	370	Alliance	18	601	1900
10000147	580/70 R 42	158 D	TL	Agri Star II	Alliance	18	577	1879
10000539	580/70 R 42	162 D/159 E	TL	VX-Tractor	Bridgestone	18	574	1875
10626795	580/70 R 42	158 D/155 E	TL	Performer 70 XL	Firestone	18	573	1894
13626713	580/70 R 42	158 D	TL	TM700	Trelleborg	18	584	1908
15225256	VF 650/65 R 42 NRO	174 D	TL	AgriStar 365	Alliance	20/21	650	1935
15727200	650/65 R 42	168 A8/165 D	TL	Agrimax RT 657	BKT	20/18	645	1913
15727201	VF 650/65 R 42 NRO	174 D	TL	Agrimax V-Flecto	BKT	23/20/21	650	1913
10000541	650/65 R 42	165 D/161 E	TL	VX-Tractor	Bridgestone	20	646	1911
10629090	VF 650/65 R 42 NRO	170 D/167 E	TL	VT Tractor	Bridgestone	23/20/21	650	1922
10627252	650/65 R 42	158 D/155 E	TL	Maxi Traction 65	Firestone	20	625	1926
12427130	650/65 R 42	158 D	TL	Gripker	Kleber	20	636	1937
13327700	650/65 R 42	158 D	TL	MultiBib	Michelin	20	638	1931
13326650	VF 650/65 R 42	174 D/171 E	TL	AxioBib 2	Michelin	23/21	671	1920
10928235	650/65 R 42	168 A8/165 D	TL	AC 65	Mitas	20/18	641	1936
10928237	VF 650/65 R 42	170 D	TL	HC 2000	Mitas	23/21	678	1910
17427436	650/65 R 42	170 D/167 E	TL	Ground King	Nokian	20	645	1913
17426678	650/65 R 42	170 D	TL	Tractor King	Nokian	20/21/23	636	1913
13626715	650/65 R 42	158 D	TL	TM800	Trelleborg	20/18	645	1913
10000995	VF 650/65 R 42	174 D/171 E	TL	TM1000PT	Trelleborg	23/20/21	665	1935
14825835	650/65 R 42	158 D	TL	TRAXION 65	Vredestein	20/18	650	1925
10001398	VF 650/65 R 42 NRO	174 D	TL	TRAXION OPTIMALL	Vredestein	23/20/21	665	1925
15226831	620/70 R 42	173 A8/170 B	TL	360	Alliance	20	650	1940
15726969	620/70 R 42	166 D	TL	Agrimax RT 765	BKT	20/18	625	1935
15726973	620/70 R 42	173 D	TL	Agrimax RT 765	BKT	20/18	625	1935
10000540	620/70 R 42	166 D/163 E	TL	VX-Tractor	Bridgestone	20/18	640	1966
10000552	VF 620/70 R 42	172 D/169 E	TL	VT Tractor	Bridgestone	23/20/21	654	1935
10626801	620/70 R 42	166 D/163 E	TL	Maxi Traction	Firestone	20	640	1966
12426654	620/70 R 42	160 A8/160 B	TL	Fitker	Kleber	20/18	631	1952
13327975	620/70 R 42	160 D	TL	OmniBib	Michelin	20/18	639	1953
13626662	620/70 R 42	166 D	TL	TM700	Trelleborg	20/18	625	1935
10000274	620/70 R 42	166 D	TL	TRAXION 70	Vredestein	20/18	625	1930
15225258	VF 710/60 R 42 NRO	161 D	TL	Agriflex 372+	Alliance	25/23	710	1923
15727210	VF 710/60 R 42 NRO	173 D	TL	Agrimax V-Flecto	BKT	25/23	710	1930
13327870	VF 710/60 R 42	161 D	TL	XeoBib	Michelin	25	716	1920

¹ = empfohlene Felge / weitere zulässige Felgenbreiten

Alles auf einen Blick:

statischer Halbmesser in mm	Abrollumfang in mm	Tragfähigkeit in kg	km/h	Luftdruck in bar
886	5810	4750	40/50	2,40
881	5807	7300	40	2,80
896	5878	4750	40/50	2,40
881	5867	4125	40/50	1,60
905	5785	4125	40/50	1,60
864	5632	4250	40/50	1,60
850	5627	4250	65	1,60
849	5647	4750/4375	65/70	2,40
853	5682	4250/3875	65/70	1,60
864	5690	4250	65	1,60
842	5894	6700	65	2,00
878	5810	5600/5150	40/65	2,40
852	5773	6700	65	2,00
876	5753	5150/4625	65/70	2,40
820	5818	6000/5450	65/70	1,60
861	5809	4250/3875	65/70	1,60
858	5735	4250	65	1,60
858	5722	4250	65	1,60
848	5682	6700/6150	65/70	2,00
860	5798	5600/5150	40/65	2,40
866	5750	6000	65	1,60
872	5811	6000/5450	65/70	3,20
881	5799	6000	65	3,20
860	5780	4250	65	1,60
845	5810	6700/6150	65/70	2,00
890	5740	4250	65	1,60
845	5690	6700	65	2,00
887	5795	6500/6000	40/50	2,70
876	5742	5300	65	1,60
876	5804	6500	65	3,20
889	5898	5300/4875	65/70	2,40
824	5757	6300/5800	65/70	1,60
889	5898	5300/4875	65/70	2,40
866	5783	4500	40/50	1,60
863	5781	4500	65	1,60
871	5855	5300	65	2,40
885	5750	5300	65	2,40
850	5656	4625	65	1,00
860	5786	6500	65	1,60
843	5675	4625	65	1,00

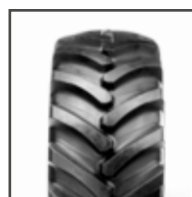

Alliance 360



Alliance 370

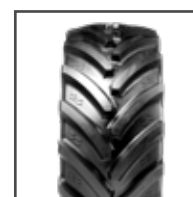

Alliance Agriflex 372+

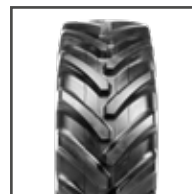

Alliance Agri Star II

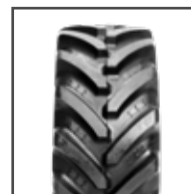

BKT Agrimax RT 657



Kleber Fitker

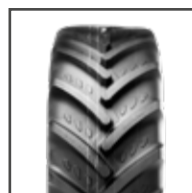

Kleber Gripker



Michelin CerexBib 2

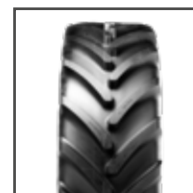

Michelin MultiBib

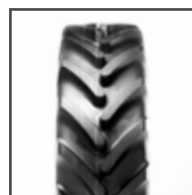

Michelin OmniBib



Michelin XeoBib

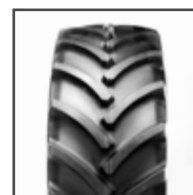

Mitas AC 65

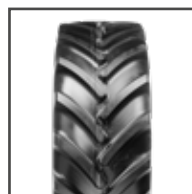

Mitas HC 2000

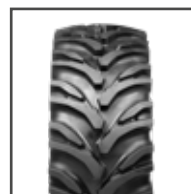

Nokian Tractor King



Trelleborg TM700



Trelleborg TM800



Trelleborg TM1000PT



Vredestein TRAXION 65



Vredestein TRAXION 70



Vredestein TRAXION 85



Vredestein TRAXION OPTIMALL



AS Reifen Radial

Preise und Bestände finden Sie unter www.bohnenkamp.de/shop



Artikel-Nr.	Größe	Last-/ Speed-Index	TL/TT	Profil	Marke	Felge ¹	Breite in mm	Außen ø in mm
13328082	VF 710/60 R 42	176 D/173 E	TL	AxioBib 2	Michelin	25/23	730	1885
13627470	VF 710/60 R 42	173 D	TL	TM1060	Trelleborg	25/23	715	1930
10001399	VF 710/60 R 42	176 D	TL	TRAXION OPTIMALL	Vredestein	25/23	730	1925
15226833	900/50 R 42	168 D	TL	Agristar 378 XL	Alliance	28/27/30	855	1947
15727217	IF 900/50 R 42 CFO	180 D	TL	Agrimax Force	BKT	30	896	1955
10629112	VF 900/50 R 42 NRO	180 D/177 E	TL	VT Tractor	Bridgestone	30/28	881	1967
13327252	900/50 R 42	168 D	TL	MachXBib	Michelin	27/28/30	853	1970
10001427	VF 900/50 R 42 NRO	180 D	TL	TRAXION OPTIMALL	Vredestein	30/28	885	1975
15225257	IF 580/85 R 42 CFO	178 D	TL	Agriflex 372	Alliance	20/18	595	2040
15727202	VF 580/85 R 42 CFO	183 D	TL	Agrimax V-Flecto	BKT	20/18	606	2058
13327104	VF 580/85 R 42 CFO+	183 A8	TL	CerexBib 2	Michelin	18	580	2040
10001178	580/85 R 42	171 A8/168 D	TL	SFT	Mitas	18/20/21	590	2050
15726985	650/75 R 42	170 D	TL	Agrimax RT 765	BKT	21/20/23	655	2043
10928240	650/75 R 42	168 A8/165 D	TL	SFT	Mitas	21/20/23	650	2035
10000993	VF 650/75 R 42	180 D/177 E	TL	TM1000PT	Trelleborg	23	670	2065
15228925	710/70 R 42	173 D	TL	Agri Star II	Alliance	23/25	720	2061
15225262	710/70 R 42	176 A8/173 D	TL	Agristar 365	Alliance	23	740	2055
15225269	IF 710/70 R 42 CFO	179 D	TL	Agriflex 372	Alliance	25/24/23	745	2062
15225270	VF 710/70 R 42 CFO	185 D	TL	Agriflex 372+	Alliance	25	745	2062
10000688	710/70 R 42	176 A8/173 D	TL	Agrimax Factor	BKT	23/25	716	2061
15726978	710/60 R 42	173 D	TL	Agrimax RT 765M	BKT	23	716	2061
15726977	710/70 R 42	179 A8/176 D	TL	Agrimax RT 765M	BKT	23	716	2061
10000947	710/70 R 42	179 A8/176 D	TL	Agrimax Factor	BKT	23/25	716	2061
15726984	IF 710/70 R 42 CFO	179 D	TL	Agrimax Force	BKT	25/23	716	2061
15727214	VF 710/70 R 42	185 D	TL	Agrimax V-Flecto	BKT	24/23/25	720	2061
10000542	710/70 R 42	173 D/170 E	TL	VX-Tractor	Bridgestone	23/25	732	2096
10629100	VF 710/70 R 42	179 D/176 E	TL	VT Tractor	Bridgestone	25/23	731	2070
10626815	710/70 R 42	173 D/170 E	TL	Maxi Traction	Firestone	23	732	2096
13326659	710/70 R 42	173 D	TL	MachXBib	Michelin	23/25	721	2088
13328087	VF 710/70 R 42	182 D/179 E	TL	AxioBib 2	Michelin	25/23	731	2066
10928250	710/70 R 42	176 A8/173 D	TL	SFT	Mitas	23/25	731	2070
17427442	710/70 R 42	179 D/175 E	TL	Ground King	Nokian	23/25	710	2059
13626734	710/70 R 42	173 D/170 E	TL	TM900HP	Trelleborg	23/25	716	2061
13626736	710/70 R 42	179 A8	TL	TM900HP	Trelleborg	23/25	725	2070
13627350	VF 710/70 R 42	182 D/179 E	TL	TM1000PT	Trelleborg	25/23	740	2070
14826125	710/70 R 42	173 D	TL	TRAXION XXL	Vredestein	23/25	740	2060
14827147	VF 710/70 R 42	182 D	TL	TRAXION OPTIMALL	Vredestein	25/23	730	2060
10928260	680/80 R 42 CHO	183 A8/180 D	TL	SFT	Mitas	21/20/23	660	2160
10928263	680/80 R 42	183 A8/180 D	TL	SFT	Mitas	21/20/23	660	2160
15726451	IF 650/85 R 42 CFO	180 D	TL	Agrimax Force	BKT	23	650	2173
13326653	VF 650/85 R 42	183 D/180 E	TL	AxioBib 2	Michelin	23/21	670	2164

¹ = empfohlene Felge / weitere zulässige Felgenbreiten

Alles auf einen Blick:

statischer Halbmesser in mm	Abrollumfang in mm	Tragfähigkeit in kg	km/h	Luftdruck in bar
830	5574	7100/6500	65/70	2,00
835	5735	6500	65	1,60
850	5710	7100	65	2,00
861	5771	5600	65	1,60
872	5830	8000	65	1,60
844	5831	8000/7300	65/70	1,60
870	5826	5600	65	1,60
865	5820	8000	65	2,00
918	6047	7500	65	2,80
923	6166	8750	65	2,80
903	6217	8750	40	2,80
920	6100	6150/5600	40/65	2,40
916	6147	6000	65	2,40
905	6090	5600/5150	40/65	1,60
900	6160	8000/7300	65/70	2,00
952	6202	6500	65	2,40
936	6102	7100/6500	40/65	2,40
924	6114	7750	65	2,40
924	6094	9250	65	2,40
935	6198	7100/6500	40/65	2,40
922	6174	6500	65	2,40
922	6174	7750/7100	40/65	2,80
935	6198	7750/7100	40/65	2,80
919	6168	7750	65	2,40
921	6182	9250	65	2,40
942	6288	6500/6000	65/70	2,40
896	6106	7750/7100	65/70	1,60
942	6288	6500/6000	65/70	2,40
932	6195	6500	65	2,40
906	6104	8500/7750	65/70	2,00
935	6150	7100/6500	40/65	2,40
933	6245	7750/6900	65/70	3,20
910	6190	6500/6000	65/70	2,40
915	6280	7750	40	3,20
900	6190	8500/7750	65/70	2,00
940	6140	6500	65	2,40
910	6105	8500	65	2,00
965	6400	8750/8000	40/65	3,20
965	6400	8750/8000	40/65	3,20
965	6400	8000	65	2,40
948	6393	8750/8000	65/70	2,00

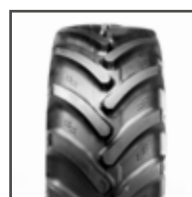

Alliance Agristar 365



Alliance Agriflex 372



Alliance Agriflex 372+

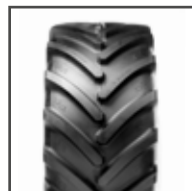

Alliance Agristar 378 XL

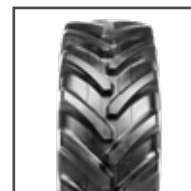

Alliance Agri Star II



BKT Agrimax Factor

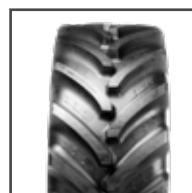

BKT Agrimax Force



BKT Agrimax RT 765 / RT 765M

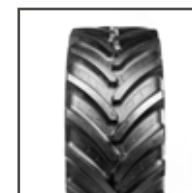

BKT Agrimax V-Flecto



Bridgestone VT Tractor



Bridgestone VX-Tractor

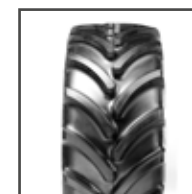

Firestone Maxi Traction



Michelin AxioBib 2



Michelin CerexBib 2



Michelin MachXBib



Mitas SFT



Nokian Ground King

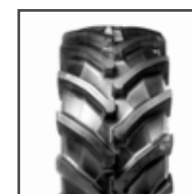

Trelleborg TM900HP

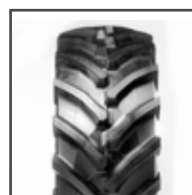

Trelleborg TM1000PT



Trelleborg TM1060



Vredestein TRAXION XXL



AS Reifen Radial

Preise und Bestände finden Sie unter www.bohnenkamp.de/shop



Artikel-Nr.	Größe	Last-/ Speed-Index	TL/TT	Profil	Marke	Felge ¹	Breite in mm	Außen ø in mm
14827142	VF 650/85 R 42	183 D	TL	TRAXION OPTIMALL	Vredestein	23/20	650	
10000994	VF 650/85 R 42	183 D/180 E	TL	TM1000PT	Trelleborg	23/21	680	2175
15225267	710/75 R 42	178 A8/175 D	TL	Agristar 378 XL	Alliance	23	730	2140
15227403	IF 710/75 R 42 CFO	176 D	TL	Agriflex 372	Alliance	25	725	2150
15225272	VF 710/75 R 42 CFO	181 D	TL	Agriflex 372+	Alliance	25	725	2153
15726986	710/75 R 42	175 D/172 E	TL	Agrimax Fortis	BKT	23/25	716	2133
15726987	IF 710/75 R 42 CFO	181 D	TL	Agrimax Force	BKT	25/23	716	2133
10000543	710/75 R 42	175 D/172 E	TL	VX-Tractor	Bridgestone	23/25	723	2127
10629110	VF 710/75 R 42	181 D/178 E	TL	VT Tractor	Bridgestone	25/23	720	2125
13328089	VF 710/75 R 42	184 D/181 E	TL	AxioBib 2	Michelin	25/23	737	2153
10928255	710/75 R 42	178 A8/175 D	TL	SFT	Mitas	23/25	751	2171
17427444	710/75 R 42	181 D/178 E	TL	Ground King	Nokian	23	710	2132
13626740	710/75 R 42	175 D/172 E	TL	TM900HP	Trelleborg	23	720	2140
13627310	IF 710/75 R 42	176 D	TL	TM1000HP	Trelleborg	25/23	730	2160
13627354	VF 710/75 R 42	184 D/181 E	TL	TM1000PT	Trelleborg	25/23	740	2160
14826130	710/75 R 42	175 D	TL	TRAXION XXL	Vredestein	23/25	735	2150
14827150	VF 710/75 R 42	184 D	TL	TRAXION OPTIMALL	Vredestein	25	730	2165
10001183	VF 800/70 R 42	189 D	TL	Agriflex 372+	Alliance	28/27/25	804	2187
10001541	IF 800/70 R 42 CFO	192 D	TL	Agrimax Force	BKT	27/25	794	2150
10928262	800/70 R 42 CHO	185 A8/182 D	TL	SFT	Mitas	25/27	774	2160
14827148	VF 800/70 R 42	189 D	TL	TRAXION OPTIMALL	Vredestein	27/25	800	2165
15226835	900/60 R 42	180 D	TL	Agristar 378 XL	Alliance	28/27/30	890	2140
10001202	VF 900/60 R 42	189 D	TL	Agriflex 372+	Alliance	30	881	2147
15727220	IF 900/60 R 42 CFO	186 D	TL	Agrimax Force	BKT	30	916	2147
15727225	VF 900/60 R 42 NRO	189 D	TL	Agrimax V-Flecto	BKT	30/28	900	2142
10629114	VF 900/60 R 42 NRO	185 D/182 E	TL	VT Tractor	Bridgestone	30/28	851	2147
13328091	VF 900/60 R 42	189 D/185 E	TL	AxioBib 2	Michelin	30/28	881	2158
10927210	900/60 R 42	183 A8/180 D	TL	SFT	Mitas	27/30	860	2150
13626750	900/60 R 42	180 D/177 E	TL	TM900HP	Trelleborg	28/27/30	905	2140
13627360	VF 900/60 R 42	189 D/186 E	TL	TM1000PT	Trelleborg	30/28	883	2150
14827145	VF 900/60 R 42 NRO	189 D	TL	TRAXION OPTIMALL	Vredestein	30/28	900	2145
15226254	210/95 R 44	129 A8/126 D	TL	350	Alliance	7	210	1495
15727495	210/95 R 44	120 A8/120 B	TL	Agrimax RT 955	BKT	7/6	214	1518
15226255	9.5 R 44	137 A8/134 D	TL	350	Alliance	7/8	241	1550
15727500	230/95 R 44	134 A8/134 B	TL	Agrimax RT 955	BKT	8/7	238	1556
10627327	230/95 R 44	148 A2/134 D	TL	Performer 95	Firestone	8/7	233	1558
12426800	230/95 R 44	137 A8/134 D	TL	Cropker	Kleber	7/8	225	1556
10001043	230/95 R 44	134 A8/134 B	TL	TM100	Trelleborg	7/8	235	1570
15226669	270/95 R 44	145 A8/142 D	TL	350	Alliance	10/8/9	284	1605

¹ = empfohlene Felge / weitere zulässige Felgenbreiten

Alles auf einen Blick:

statischer Halbmesser in mm	Abrollumfang in mm	Tragfähigkeit in kg	km/h	Luftdruck in bar
950	6395	8750	65	2,00
955	6450	8750/8000	65/70	2,00
965	6409	7500/6900	40/65	2,40
951	6318	7100	65	1,60
940	6279	8250	65	1,60
970	6406	6900/6300	65/70	2,40
967	6403	8250	65	2,40
962	6406	6900/6300	65/70	2,40
924	6318	8250/7500	65/70	1,60
950	6370	9000/8250	65/70	2,00
971	6460	7500/6900	40/65	2,40
964	6476	8250/7500	65/70	3,20
945	6415	6900/6300	65/70	2,40
940	6410	7100	65	1,60
935	6400	9000/8250	65/70	2,00
980	6395	6900	65	2,40
960	6410	9000	65	2,00
957	6440	10300	65	2,00
950	6400	11200	65	3,20
945	6320	9250/8500	40/65	2,80
930	6380	10300	65	2,00
951	6356	8000	65	2,40
937	6388	10300	65	2,00
950	6416	9500	65	2,40
937	6390	10300	65	2,00
921	6304	9250/8500	65/70	1,60
942	6357	10300/9250	65/70	2,00
970	6440	8750/8000	40/65	2,40
960	6425	8000/7300	65/70	2,40
910	6445	10300/9500	65/70	2,00
920	6315	10300	65	2,00
719	4674	1850/1700	40/65	3,60
721	4653	1400	40/50	2,40
745	4821	2300/2120	40/65	3,60
739	4788	2120	40/50	4,00
737	4797	3150/2120	10/65	4,00
738	4682	2300/2120	40/65	4,00
735	4850	2120	40/50	4,00
752	4875	2900/2650	40/65	4,00

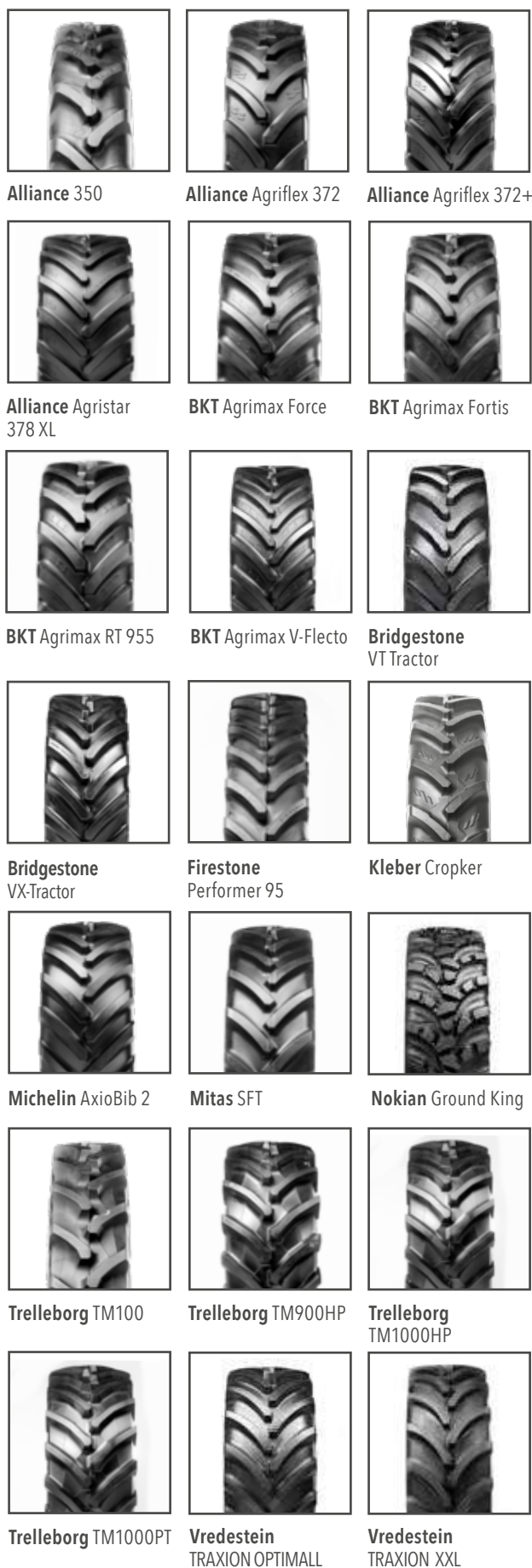



AS Reifen Radial

Preise und Bestände finden Sie unter www.bohnenkamp.de/shop



Artikel-Nr.	Größe	Last-/ Speed-Index	TL/TT	Profil	Marke	Felge ¹	Breite in mm	Außen ø in mm
15727510	270/95 R 44	142 A8/142 B	TL	Agrimax RT 955	BKT	9/8/10	275	1632
10627328	270/95 R 44	156 A2/142 D	TL	Performer 95	Firestone	9/8/10	266	1636
12426804	270/95 R 44	145 A8/142 D	TL	Cropker	Kleber	9/8/10	275	1632
10001026	270/95 R 44	142 A8/142 B	TL	TM100	Trelleborg	8/9/10	270	1645
15727235	VF 750/70 R 44	186 D	TL	Agrimax V-Flecto	BKT	25/24	760	2175
13328085	VF 750/70 R 44	186 D/183 E	TL	AxioBib 2	Michelin	25/24	763	2179
13627475	VF 750/70 R 44	183 D	TL	TM1060	Trelleborg	25	770	2195
10001428	VF 750/70 R 44	186 D	TL	TRAXION OPTIMALL	Vredestein	25/24	760	2185
15226280	270/95 R 46	144 A8/141 D	TL	350	Alliance	10/8/9	284	1665
15727583	270/95 R 46	143 A8/143 B	TL	Agrimax RT 955	BKT	9/8/10	275	1683
15727571	320/90 R 46	151 A8/148 D	TL	Agrimax RT 945	BKT	10/9/11	319	1744
15226300	320/90 R 46	151 A8/148 D	TL	350	Alliance	11/9/10	315	1727
15226315	IF 320/90 R 46	155 D	TL	Agriflex 354	Alliance	10/11	320	1744
15226885	IF 320/90 R 46	155 D	TL	Agriflex 363	Alliance	10/11/12	308	1748
10926528	320/95 R 46	152 A8/152 B	TL	AC 85	Mitas	10/9/11	330	1770
15226306	300/95 R 46	151 A8/148 D	TL	350	Alliance	11/9/10	315	1727
15727584	300/95 R 46	148 A8/148 B	TL	Agrimax RT 955	BKT	9/10/11	295	1738
10627332	300/95 R 46	162 A2/148 D	TL	Performer 95	Firestone	10/9/11	313	1737
12426815	300/95 R 46	151 A8/148 D	TL	Cropker	Kleber	9/8/10	299	1734
10001025	300/95 R 46	148 A8/148 B	TL	TM100	Trelleborg	10/9/11	310	1755
15226310	340/85 R 46	153 A8/150 D	TL	350	Alliance	12/10/11	340	1760
15727586	340/85 R 46	150 A8/150 B	TL	Agrimax RT 955	BKT	12/10/11	353	1746
13327751	340/85 R 46	150 A8/150 B	TL	AgriBib RC	Michelin	12/10	338	1747
15226313	IF 320/105 R 46	166 D	TL	Agriflex 354	Alliance	11/10/12	345	1840
13627366	VF 380/85 R 46	162 D/159 E	TL	TM1000PT	Trelleborg	12/13	360	1825
15226322	380/90 R 46	175 A8/172 D	TL	350	Alliance	13/11/12	378	1824
15227799	380/90 R 46	165 A8/165 B	TL	FarmPRO Radial 90	Alliance	12/11/13	380	1863
15226890	IF 380/90 R 46	168 D	TL	Agriflex 363	Alliance	13/12	389	1842
15226327	VF 380/90 R 46	173 D	TL	Agriflex 354 +	Alliance	13/12	391	1854
15727580	380/90 R 46	159 A8/159 B	TL	Agrimax RT 945	BKT	12/11/13	380	1852
10000952	VF 380/90 R 46	175 D	TL	Agrimax Spargo	BKT	13/12	390	1852
13327760	VF 380/90 R 46	173 D	TL	SprayBib	Michelin	13/12	383	1842
10926530	380/90 R 46	149 A8/149 B	TL	AC 85 Row Crop	Mitas	12/11/13	392	1844
10926492	380/90 R 46	159 A8/159 B	TL	AC 85	Mitas	12/11/13	392	1844
15227412	420/80 R 46	162 A8/159 D	TL	385	Alliance	13/12/14	420	1861
10000151	420/80 R 46	159 D	TL	Agri Star II	Alliance	13/12	418	1840
10001215	VF 420/80 R 46	172 D	TL	Agriflex 354 +	Alliance	13	418	1840
15726458	420/80 R 46	170 A2/159 D	TL	Agrimax RT 855	BKT	13/12	418	1840
13328220	420/80 R 46	151 A8/151 B	TL	AgriBib 2	Michelin	13	418	1840
15227423	18.4 R 46	176 A8/176 B	TL	Power Drive 356	Alliance	16/15	467	1958

¹ = empfohlene Felge / weitere zulässige Felgenbreiten

Alles auf einen Blick:

statischer Halbmesser in mm	Abrollumfang in mm	Tragfähigkeit in kg	km/h	Luftdruck in bar
764	4983	2650	40/50	4,00
774	5037	4000/2650	10/65	4,00
768	4884	2900/2650	40/65	4,00
770	5020	2650	40/50	4,00
958	6450	9500	65	2,40
956	6438	9500/8750	65/70	2,00
945	6510	8750	65	1,60
940	6450	9500	65	2,00
774	5121	2800/2575	40/65	3,60
792	5169	2725	40/50	4,00
810	5232	3450/3150	40/65	3,60
807	5294	3450/3150	40/65	3,60
814	5283	3875	65	3,60
821	5324	3875	65	3,60
806	5298	3550	40/50	4,00
807	5294	3450/3150	40/65	3,60
812	5318	3150	40/50	4,00
822	5348	4750/3150	10/65	4,00
813	5203	3450/3150	40/65	4,00
840	5400	3150	40/50	4,00
824	5360	3650/3350	40/65	3,60
826	5346	3350	40/50	3,60
810	5227	3350	40/50	3,60
857	5553	5300	65	4,80
830	5490	4750/4375	65/70	2,80
851	5482	6900/6300	40/65	5,80
860	5495	5150	40/50	4,90
853	5592	5600	65	4,40
861	5549	6500	65	4,40
859	5699	4375	40/50	4,00
846	5611	6900	65	4,60
848	5530	6500	65	4,40
846	5542	3250	40/50	2,40
846	5542	4375	40/50	4,00
860	5611	4750/4375	40/65	3,20
860	5598	4375	65	3,60
833	5518	6300	65	4,00
863	5641	6000/4375	10/65	3,20
846	5496	3450	40/50	2,40
906	5918	7100	40/50	3,50



Alliance 350

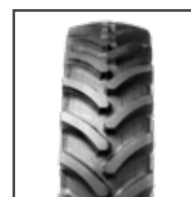

Alliance Agriflex 354 +

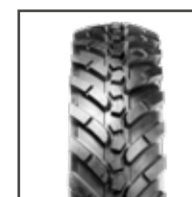

Alliance Agriflex 363

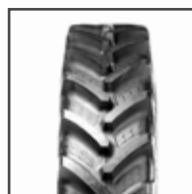

Alliance 385



Alliance Agri Star II



Alliance FarmPRO Radial 90



BKT Agrimax RT 855



BKT Agrimax RT 955



BKT Agrimax Spargo

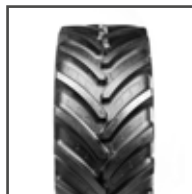

BKT Agrimax V-Flecto

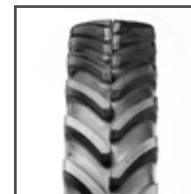

Firestone Performer 95



Kleber Cropker



Michelin AgriBib 2



Michelin AgriBib RC



Michelin AxioBib 2

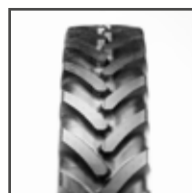

Michelin SprayBib

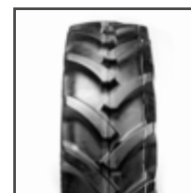

Mitas AC 85 / AC 85 Row Crop



Trelleborg TM100

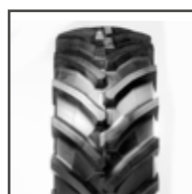

Trelleborg TM1000PT

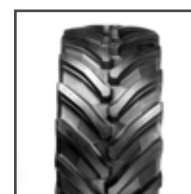

Trelleborg TM1060



AS Reifen Radial

Preise und Bestände finden Sie unter www.bohnenkamp.de/shop

Artikel-Nr.	Größe	Last-/ Speed-Index	TL/ TT	Profil	Marke	Felge ¹	Breite in mm	Außen ø in mm
15228796	480/80 R 46	158 D	TL	Agri Star II	Alliance	16/15/14	494	1960
15226324	VF 480/80 R 46	164 D	TL	Agriflex 354 +	Alliance	16/15	489	1948
15726460	480/80 R 46	158 A8/158 B	TL	Agrimax RT 855	BKT	16	479	1936
15726465	480/80 R 46	164 A8/164 B	TL	Agrimax RT 855	BKT	16	479	1936
15726467	VF 480/80 R 46	177 D	TL	Agrimax Spargo	BKT	16/15	479	1936
13328223	480/80 R 46	158 A8/158 B	TL	AgriBib 2	Michelin	16	486	1945
13327982	VF 480/80 R 46	164 A8/164 B	TL	YieldBib	Michelin	16	480	1933
13327765	VF 480/80 R 46	177 D	TL	SprayBib	Michelin	16/15	485	1943
10928265	480/80 R 46	158 A8/158 B	TL	AC 85	Mitas	16/14/15	507	1960
13626760	480/80 R 46	158 A8/158 B	TL	TM600	Trelleborg	16	495	1964
14826540	480/80 R 46	158 A8/158 B	TL	TRAXION 85	Vredestein	16	500	1950
15228798	520/85 R 46	158 D	TL	Agri Star II	Alliance	16/18	520	2054
15227430	520/85 R 46	173 A8/169 D	TL	Agristar 375	Alliance	16/15/18	530	2050
15226328	VF 520/85 R 46	170 D	TL	Agriflex 354 +	Alliance	18/16	530	2052
15726470	520/85 R 46	158 A8/158 B	TL	Agrimax RT 855	BKT	16/18	516	2052
15726472	520/85 R 46	173 A8/173 B	TL	Agrimax RT 855	BKT	16/18	516	2052
13328226	520/85 R 46	164 A8/164 B	TL	AgriBib 2	Michelin	16/18	516	2052
10928270	520/85 R 46	158 A8/158 B	TL	AC 85	Mitas	16/18	545	2043
13626770	520/85 R 46	158 A8/158 B	TL	TM600	Trelleborg	16/18	535	2045
14826480	520/85 R 46	158 A8/158 B	TL	TRAXION 85	Vredestein	16/18	535	2050
15226845	620/70 R 46	162 A8/159 D	TL	Multistar 376	Alliance	20	620	2060
15726992	620/70 R 46	162 D	TL	Agrimax RT 765	BKT	20	625	2036
13327259	620/70 R 46	162 D	TL	MachXBib	Michelin	20/18	636	2042
10000983	VF 710/60 R 46	186 D/182 E	TL	SprayBib	Michelin	25	722	2002
15726991	IF 750/75 R 46 CFO	186 D	TL	Agrimax Force	BKT	25	742	2294
13327270	IF 750/75 R 46	186 D	TL	AxioBib	Michelin	25	761	2287
13627370	VF 750/75 R 46	189 D/186 E	TL	TM1000PT	Trelleborg	25	760	2285
13327275	IF 900/65 R 46	190 D	TL	AxioBib	Michelin	30	915	2322
10000968	VF 900/65 R 46	193 D/190 E	TL	TM1000PT	Trelleborg	30	895	2230
15226335	9.5 R 48	139 A8/136 D	TL	350	Alliance	8/7	241	1650
15226892	VF 230/95 R 48	146 D	TL	Agriflex 363 +	Alliance	8/9	232	1660
15727596	230/95 R 48	136 A8/136 B	TL	Agrimax RT 955	BKT	8/7	238	1656
10627346	230/95 R 48	150 A2/136 D	TL	Performer 95	Firestone	8/7	229	1664
12426819	230/95 R 48	139 A8/136 D	TL	Cropker	Kleber	7/8	224	1659
10001024	230/95 R 48	136 A8/136 B	TL	TM100	Trelleborg	7/8	238	1673
15226365	11.2 R 48	145 A8/142 D	TL	350	Alliance	10/8/9	284	1710
15226893	VF 270/95 R 48	155 D	TL	Agriflex 363 +	Alliance	10/9	275	1733
15727600	270/95 R 48	144 A8/144 B	TL	Agrimax RT 955	BKT	9/8/10	275	1733
10627347	270/95 R 48	158 A2/144 D	TL	Performer 95	Firestone	9/8/10	270	1736

¹ = empfohlene Felge / weitere zulässige Felgenbreiten

Alles auf einen Blick:

statischer Halbmesser in mm	Abrollumfang in mm	Tragfähigkeit in kg	km/h	Luftdruck in bar
909	5873	4250	65	2,40
876	5806	5000	65	1,60
895	5871	4250	40/50	2,40
895	5871	5000	40/50	3,20
889	5861	7300	65	3,60
891	5804	4250	40/50	2,40
861	5732	5000	40/50	1,60
885	5790	7300	65	3,60
896	5886	4250	40/50	2,40
887	5950	4250	40/50	2,40
900	5885	4250	40/50	2,40
940	6137	4250	65	1,60
941	6114	6500/5800	40/65	3,20
916	6026	6000	65	1,60
949	6157	4250	40/50	1,60
949	6252	6500	40/50	4,00
931	6110	5000	40/50	2,40
930	6131	4250	40/50	1,60
905	6160	4250	40/50	1,60
930	6150	4250	40/50	1,60
940	6140	4750/4375	40/65	1,60
924	6106	4750	65	1,60
910	6055	4750	65	1,60
900	5948	9500/8500	65/70	3,20
1032	6802	9500	65	2,40
1043	6819	9500	65	2,40
993	6850	10300/9500	65/70	2,00
1038	6888	10600	65	2,40
1010	6910	11500/10600	65/70	2,00
787	5039	2430/2240	40/65	3,60
784	5058	3000	65	3,60
792	5085	2240	40/50	4,00
787	5123	3350/2240	10/65	4,00
786	4989	2430/2240	40/65	4,00
780	5170	2240	40/50	4,00
811	5289	2900/2650	40/65	3,60
816	5329	3875	65	4,00
820	5351	2800	40/50	4,00
820	5345	4250/2800	10/65	4,00





AS Reifen Radial

Preise und Bestände finden Sie unter www.bohnenkamp.de/shop

Artikel-Nr.	Größe	Last-/ Speed-Index	TL/ TT	Profil	Marke	Felge ¹	Breite in mm	Außen ø in mm
12426822	270/95 R 48	147 A8/144 D	TL	Cropker	Kleber	9/8/10	277	1736
10926494	270/95 R 48	144 A8/141 B	TL	AC 90	Mitas	10/8/9	287	1737
10001044	270/95 R 48	144 A8/144 B	TL	TM100	Trelleborg	8/9/10	280	1750
15226395	13.6 R 48	154 A8/151 D	TL	350	Alliance	12/11	345	1805
15226396	13.6 R 48	159 A8/156 D	TL	350	Alliance	12/11	345	1805
15227436	VF 340/85 R 48	164 D	TL	Agriflex 354 +	Alliance	12/11	343	1808
15727610	340/85 R 48	152 A8/152 B	TL	Agrimax RT 955	BKT	12/11	353	1797
10627349	340/85 R 48	165 A2/151 D	TL	Performer 85	Firestone	12/11	342	1799
10926497	340/90 R 48	154 A8/154 B	TL	AC 85	Mitas	12/11	348	1825
15226678	320/90 R 50	153 A8/150 D	TL	350	Alliance	11/9/10	325	1867
15226684	VF 320/90 R 50	166 D	TL	Agriflex 354 +	Alliance	11/10/12	319	1848
15727630	320/90 R 50	150 A8/150 B	TL	Agrimax RT 945	BKT	10/9/11	319	1846
10928285	320/90 R 50	150 A8/150 B	TL	AC 85	Mitas	10/9/11	315	1870
10000982	VF 320/90 R 50 CFO	166 D/162 E	TL	SprayBib	Michelin	11/10	323	1849
15226690	VF 320/105 R 50	158 D	TL	Agriflex 354 +	Alliance	11/12	323	1938
15226679	380/90 R 50	154 A8/151 D	TL	350	Alliance	12/11	384	1950
15226676	380/90 R 50	161 A8/158 D	TL	350	Alliance	12/11/13	384	1950
15226674	IF 380/90 R 50	170 D	TL	Agriflex 354	Alliance	13/12	385	1956
15727641	380/90 R 50	160 A8/160 B	TL	Agrimax RT 945	BKT	12/11/13	390	1954
15727629	VF 380/90 R 50	169 D	TL	Agrimax Spargo	BKT	11/10	323	1846
15727643	VF 380/90 R 50	175 D	TL	Agrimax Spargo	BKT	13/12	390	1950
13327724	IF 380/90 R 50	167 A8/167 B	TL	AgriBib RC	Michelin	13/12	395	1953
13326706	VF 380/90 R 50	175 D	TL	SprayBib	Michelin	13/12	385	1947
10001023	380/90 R 50	151 A8/151 B	TL	TM100	Trelleborg	12/11/13	380	1945
15226677	380/105 R 50	171 A8/168 D	TL	350	Alliance	12/11	405	2050
15226688	IF 380/105 R 50	177 D	TL	Agriflex 354	Alliance	13/12	399	2052
15226691	VF 380/105 R 50	179 D	TL	Agriflex 363 +	Alliance	13	400	2050
15727645	VF 380/105 R 50	179 D	TL	Agrimax Spargo	BKT	13/12	400	2050
15226686	VF 420/95 R 50	177 D	TL	Agriflex 354 +	Alliance	14/13	425	2052
15727655	VF 420/95 R 50	177 D	TL	Agrimax Spargo	BKT	14/13	419	2068
13326707	VF 420/95 R 50	177 D	TL	SprayBib	Michelin	13/14	413	2052
15228498	480/80 R 50	159 D	TL	Agri Star II	Alliance	16/15	494	2060
15227500	480/80 R 50	168 A8/165 D	TL	385	Alliance	15/14	480	2060
15226896	VF 480/80 R 50	169 D	TL	Agriflex 363 +	Alliance	16/15	475	2038
15226683	VF 480/80 R 50	171 D	TL	Agriflex 354 +	Alliance	16/15	479	2050
15226689	VF 480/80 R 50	179 D	TL	Agriflex 354 +	Alliance	16/15	479	2050
15726480	480/80 R 50	159 A8/159 B	TL	Agrimax RT 855	BKT	16/15	489	2036
15726481	480/80 R 50	176 A8	TL	Agrimax RT 855	BKT	16/15	489	2036
15726483	VF 480/80 R 50	179 D	TL	Agrimax Spargo	BKT	16/15	479	2038

¹ = empfohlene Felge / weitere zulässige Felgenbreiten

Alles auf einen Blick:

statischer Halbmesser in mm	Abrollumfang in mm	Tragfähigkeit in kg	km/h	Luftdruck in bar
819	5217	3075/2800	40/65	4,00
810	5220	2800/2575	40/50	4,00
830	5350	2800	40/50	4,00
854	5568	3750/3450	40/65	4,20
854	5600	4375/4000	40/65	4,80
841	5489	5000	65	4,00
855	5572	3550	40/50	4,00
851	5531	5150/3450	10/65	3,60
843	5481	3750	40/50	4,00
878	5684	3650/3350	40/65	3,60
864	5620	5300	65	4,40
873	5618	3350	40/50	3,60
873	5680	3350	40/50	3,60
865	5545	5300/4750	65/70	4,40
894	5836	4250	65	2,40
916	5939	3750/3450	40/65	2,40
916	5939	4625/4250	40/65	3,60
906	5896	6000	65	4,40
921	5958	4500	40/50	4,00
865	5650	5800	65	4,80
893	5950	6900	65	4,40
903	5841	5450	40/50	4,00
913	5836	6900	65	4,40
890	5885	3450	40/50	2,40
955	6214	6150/5600	40/65	4,40
947	6187	7300	65	4,80
945	6206	7750	65	4,40
934	6211	7750	65	4,40
932	6131	7300	65	3,60
943	6210	7300	65	3,60
937	6118	7300	65	3,60
932	6146	4375	65	2,40
958	6228	5600/5150	40/65	3,20
919	6103	5800	65	2,00
936	6114	6150	65	2,40
936	6114	7750	65	3,60
941	6183	4375	40/50	2,40
945	6183	7100/6500	40	5,00
947	6224	7750	65	3,60



Alliance 350

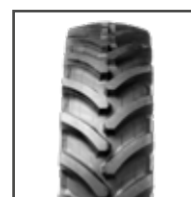

Alliance Agriflex 354 /
Agriflex 354 +

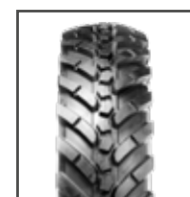

Alliance
Agriflex 363+



Alliance 385

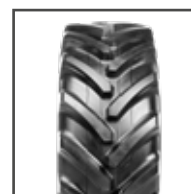

Alliance Agri Star II



BKT Agrimax RT 855

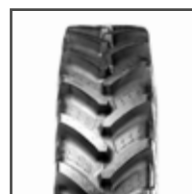

BKT Agrimax RT 945

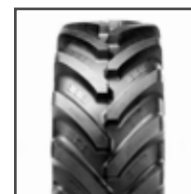

BKT Agrimax RT 955

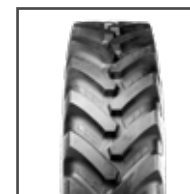

BKT Agrimax Spargo

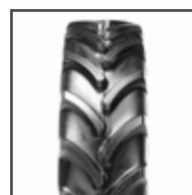

Firestone
Performer 85



Kleber Cropker



Michelin AgriBib RC

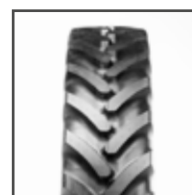

Michelin SprayBib

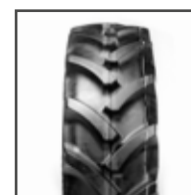

Mitas AC 85

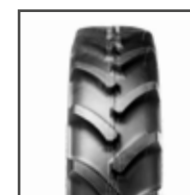

Mitas AC 90



Trelleborg TM100



AS Reifen Radial

Preise und Bestände finden Sie unter www.bohnenkamp.de/shop

Artikel-Nr.	Größe	Last-/ Speed-Index	TL/ TT	Profil	Marke	Felge ¹	Breite in mm	Außen ø in mm
13326712	480/80 R 50	159 A8/159 B	TL	AgriBib 2	Michelin	15/16	465	2050
13327983	VF 480/80 R 50	166 A8/166 B	TL	YieldBib	Michelin	15/16	468	2039
13326709	VF 480/80 R 50	179 D	TL	SprayBib	Michelin	16/15	480	2050
10928275	480/80 R 50	159 A8/159 B	TL	AC 85	Mitas	16/14/15	495	2065
13626790	480/80 R 50	159 D	TL	TM600	Trelleborg	15/16	500	2045
14826550	480/80 R 50	159 A8/159 B	TL	TRAXION 85	Vredestein	16/14/15	500	2045
15226682	VF 480/95 R 50	176 D	TL	Agriflex 354 +	Alliance	16/15	485	2187
15727680	IF 480/95 R 50	170 D	TL	Agrimax Force	BKT	16	479	2170
13326715	480/95 R 50	164 A8/164 B	TL	AgriBib	Michelin	16/15	450	2175
13327985	VF 480/95 R 50	170 A8/170 B	TL	YieldBib	Michelin	16/15	477	2186
15726490	520/85 R 50	165 A8/165 B	TL	Agrimax RT 855	BKT	16/18/15	516	2154
15226680	300/95 R 52	151 A8/148 D	TL	350	Alliance	10/8/9	310	1890
15226685	300/95 R 52	159 A8/156 D	TL	350	Alliance	10/8/9	310	1890
15727700	300/95 R 52	151 A8/151 B	TL	Agrimax RT 955	BKT	9/10/11	295	1891
10627363	300/95 R 52	165 A2/151 D	TL	Performer 95	Firestone	10/9/11	301	1893
12426825	300/95 R 52	154 A8/151 D	TL	Cropker	Kleber	9/8/10	297	1886
15226700	270/95 R 54	149 A8/146 D	TL	350	Alliance	10/8/9	285	1900
15226701	270/95 R 54	159 A8/156 D	TL	350	Alliance	10/8/9	285	1900
15226897	VF 270/95 R 54	156 D	TL	Agriflex 363 +	Alliance	10/9	287	1894
15727720	270/95 R 54	146 A8/146 B	TL	Agrimax RT 955	BKT	9/8/10	275	1885
12426830	270/95 R 54	149 A8/146 D	TL	Cropker	Kleber	9/8/10	275	1887
15226704	IF 270/105 R 54	158 D	TL	Agriflex 354	Alliance	10	280	1946
15226695	VF 230/115 R 54	151 D	TL	Agriflex 354 +	Alliance	8	257	1947
15226706	320/90 R 54	154 A8/151 D	TL	350	Alliance	10/9/11	325	1958
15226707	VF 320/90 R 54	168 D	TL	Agriflex 354 +	Alliance	11/10/12	320	1950
15727731	320/90 R 54	156 A8/156 B	TL	Agrimax RT 945	BKT	10/9/11	319	1948
13327728	IF 320/90 R 54	159 A8/159 B	TL	AgriBib RC	Michelin	11/10	322	1949
10001137	VF 320/105 R 54	172 D	TL	Agriflex 354 +	Alliance	11/12/10	325	2040
10001161	VF 320/105 R 54	172 D	TL	SprayBib	Michelin	11	339	2028
15226723	380/90 R 54	174 A8/171 D	TL	350	Alliance	12/11/13	388	2055
15226725	VF 380/90 R 54	176 D	TL	Agriflex 354 +	Alliance	13/12	383	2050
15727732	380/90 R 54	158 A8/158 B	TL	Agrimax RT 945	BKT	12/11/13	380	2056
13328229	380/90 R 54	152 A8/152 B	TL	AgriBib 2	Michelin	12/13	386	2054
13327770	VF 380/90 R 54	176 D	TL	SprayBib	Michelin	13/12	384	2049
10001022	380/90 R 54	152 A8/152 B	TL	TM100	Trelleborg	12/11/13	380	2040
15226727	IF 380/105 R 54	180 D	TL	Agriflex 354	Alliance	13/12	395	2163
13627344	VF 480/95 R 54	180 D/177 E	TL	TM1000PT	Trelleborg	15	480	2295

¹ = empfohlene Felge / weitere zulässige Felgenbreiten

Alles auf einen Blick:

statischer Halbmesser in mm	Abrollumfang in mm	Tragfähigkeit in kg	km/h	Luftdruck in bar
939	6116	4375	40/50	2,40
901	6034	5300	40/50	1,60
939	6118	7750	65	3,60
945	6210	4375	40/50	2,40
935	6190	4375	65	2,40
950	6225	4375	40/50	2,40
984	6550	7100	65	2,40
994	6488	6000	65	2,40
992	6484	5000	40/50	2,40
962	6661	6000	40/50	1,60
992	6472	5150	40/50	2,40
896	5790	3450/3150	40/65	3,60
896	5790	4375/4000	40/65	4,80
889	5774	3450	40/50	4,00
894	5828	5150/3450	10/65	4,00
888	5664	3750/3450	40/65	4,00
903	5826	3250/3000	40/65	3,60
903	5826	4375/4000	40/65	6,00
894	5763	4000	65	3,60
894	5815	3000	40/50	4,00
896	5679	3250/3000	40/65	4,00
917	5949	4250	65	4,00
912	5931	3450	65	3,20
928	6093	3750/3450	40/65	3,60
911	5944	5600	65	4,40
930	6021	4000	40/50	4,40
915	5848	4375	40/50	4,00
950	6230	6300	65	4,40
938	6066	6300	65	4,40
960	6257	6700/6150	40/65	4,80
951	6199	7100	65	4,40
962	6296	4250	40/50	3,20
949	6129	3550	40/50	2,40
950	6131	7100	65	4,40
940	6175	3550	40/50	2,40
1001	6532	8000	65	5,20
1040	6865	8000/7300	65/70	2,80



Alliance 350

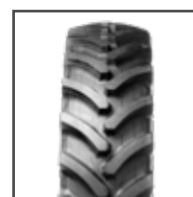

Alliance Agriflex 354 /
Agriflex 354 +

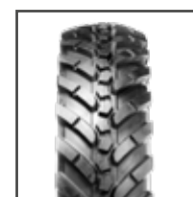

Alliance
Agriflex 363+



BKT Agrimax Force



BKT Agrimax RT 855

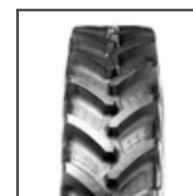

BKT Agrimax RT 945

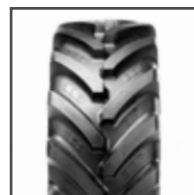

BKT Agrimax RT 955

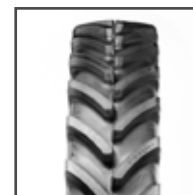

Firestone
Performer 95



Kleber Cropker



Michelin AgriBib



Michelin AgriBib 2

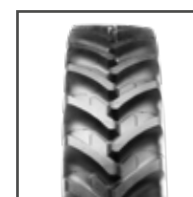

Michelin AgriBib RC

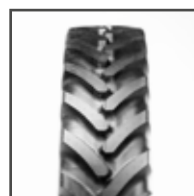

Michelin SprayBib



Michelin YieldBib

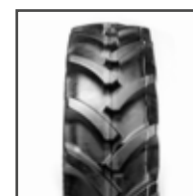

Mitas AC 85

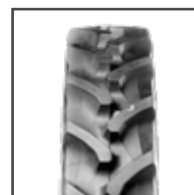

Trelleborg TM100



Trelleborg TM600



Trelleborg TM1000PT

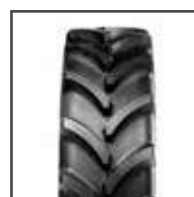

Vredestein
TRAXION 85

112

Kommunalreifen



KOMMUNALREIFEN

Bohnenkamp

■ ■ ■ Moving Professionals

SERVICE-PLUS BY BOHNENKAMP

Erhalten Sie direkten Zugriff
auf unseren Online-Shop





Kommunalreifen

Preise und Bestände finden Sie unter www.bohnenkamp.de/shop

Artikel-Nr.	Größe	Last-/ Speed-Index	TL/ TT	Profil	Marke	Felge ¹	Breite in mm	Außen ø in mm
15226930	220/55 R 12	82 A8/82 B	TL	579	Alliance	7.00	220	550
15226933	240/60 R 12	89 A8/89 B	TL	579	Alliance	8.00/7.00	240	592
15226935	220/55 R 14	93 A8/93 B	TL	579	Alliance	7.00	220	592
15226940	200/60 R 15	83 A8/83 B	TL	579	Alliance	7	200	620
15226942	200/65 R 16	94 A8/94 B	TL	579	Alliance	6	198	666
15226945	200/70 R 16	94 A8/94 B	TL	579	Alliance	6	198	686
15226948	240/70 R 16	104 A8/104 B	TL	579	Alliance	8	245	740
15775005	240/70 R 16	107 A8/107 B	TL	Ridemax IT 696	BKT	8/9	244	742
15284003	250/75 R 16	120 G	TL	Multiuse 550	Alliance	8	253	781
17425995	250/75 R 16	120 G	TL	TRI 2	Nokian	8/7/7.5/8.5/9/9.00	258	782
15284005	250/80 R 16	126 A8/123 D	TL	Multiuse 550	Alliance	8/7/9	270	814
13375300	250/80 R 16	124 A8/120 D	TL	CrossGrip	Michelin	8/7/9	259	804
17426000	250/80 R 16	119 G	TL	TRI 2	Nokian	8/7/7.5/8.5/9	268	814
15226950	260/70 R 16	109 A8/109 B	TL	579	Alliance	8/9	260	770
15726539	260/70 R 16	109 A8/109 B	TL	Agrimax Turf RT 333	BKT	8/9	258	770
15226953	280/70 R 16	112 A8/112 B	TL	579	Alliance	8/9/10	282	800
15726538	280/70 R 16	112 A8/112 B	TL	Agrimax Turf RT 333	BKT	9/8/10	289	800
15284015	265/70 R 16.5	130 A2	TL	Multiuse 550	Alliance	8.25	264	773
15284020	305/70 R 16.5	141 A5	TL	Multiuse 550	Alliance	9.75	304	832
15226957	260/70 R 18	114 A8/114 B	TL	579	Alliance	8/9	258	821
15226963	280/70 R 18	114 A8/114 B	TL	579	Alliance	9	282	849
15726567	280/70 R 18	114 A8/114 B	TL	Agrimax Turf RT 333	BKT	9/8/10	289	840
15226960	320/65 R 18	109 A8/106 B	TL	579	Alliance	10	310	873
10001305	320/65 R 18	109 A8/109 B	TL	Agrimax Turf RT 333	BKT	10/9/11	319	873
15284032	340/80 R 18	143 A8/138 D	TL	Multiuse 550	Alliance	11	343	1002
15775010	340/80 R 18	143 A8/138 D	TL	Ridemax IT 696	BKT	11/10/12	343	1001
13375310	340/80 R 18	143 A8/138 D	TL	CrossGrip	Michelin	11/10/12	352	1000
17427220	340/80 R 18	138 D	TL	Hakkapeliitta TRI	Nokian	11	340	1001
17426010	340/80 R 18	143 A8/138 D	TL	TRI 2	Nokian	11/10/12	343	1001
17427222	400/60 R 18	143 D	TL	Hakkapeliitta TRI	Nokian	13	400	950
15284036	405/70 R 18	153 A2/141 B	TL	Multiuse 550	Alliance	13/12/14	404	1021
15226966	300/70 R 20	110 A8/110 B	TL	579	Alliance	9	295	954
15726581	300/70 R 20	110 A8/110 B	TL	Agrimax Turf RT 333	BKT	9/10	295	955
15226970	320/70 R 20	113 A8/113 B	TL	579	Alliance	10	320	982
15726591	320/70 R 20	113 A8/113 B	TL	Agrimax Turf RT 333	BKT	10/9/11	319	982
15284038	340/80 R 20	144 A8/140 D	TL	Multiuse 550	Alliance	11	343	1052
15284043	360/70 R 20	129 A8/124 D	TL	Multiuse 550	Alliance	11/10/12	355	1051
17426015	360/70 R 20	136 A8/131 D	TL	TRI 2	Nokian	11/10/12	357	1028
15284041	360/80 R 20	147 A8/143 D	TL	Multiuse 550	Alliance	11	358	1092
10001136	360/80 R 20	147 A8/143 D	TL	Ridemax IT 696	BKT	11.00/10/11/12	357	1084
17427224	360/80 R 20	143 D	TL	Hakkapeliitta TRI	Nokian	11	360	1093

¹ = empfohlene Felge / weitere zulässige Felgenbreiten

Alles auf einen Blick:

statischer Halbmesser in mm	Abrollumfang in mm	Tragfähigkeit in kg	km/h	Luftdruck in bar
252	1639	475	40/50	2,40
269	1764	580	40/50	2,40
260	1765	650	40/50	3,80
286	1856	487	40/50	2,40
307	1968	670	40/50	2,40
330	1997	670	40/50	2,40
345	2190	900	40/50	2,40
343	2226	975	40/50	2,80
362	2341	1400	90	4,50
363	2390	1400	90	4,50
373	2470	1700/1550	40/65	4,40
364	2402	1600/1400	40/65	4,00
383	2488	1360	90	4,50
350	2295	1030	40/50	2,40
348	2287	1030	40/50	2,40
363	2384	1120	40/50	2,40
359	2371	1120	40/50	2,40
349	2345	1900	10	4,00
374	2469	2575	25	4,00
382	2460	1180	40/50	2,80
387	2530	1180	40/50	2,40
390	2550	1180	40/50	2,40
389	2575	1030/950	40/50	1,60
394	2591	1030	40/50	1,60
450	2957	2725/2360	40/65	4,00
458	2980	2725/2360	40/65	4,00
453	3094	2725/2360	40/65	4,00
452	3031	2360	65	4,00
453	3010	2725/2360	40/65	4,00
427	2870	2725	65	5,00
468	3059	3650/2575	10/50	3,75
435	2843	1060	40/50	1,60
431	2826	1060	40/50	1,60
446	2926	1150	40/50	1,60
441	2916	1150	40/50	1,60
477	3148	2800/2500	40/65	4,00
472	3121	1850/1600	40/65	2,40
469	3104	2240/1950	40/65	3,20
492	3265	3075/2725	40/65	4,00
488	3235	3075/2725	40/65	4,00
493	3311	2725	65	4,00



Alliance Multiuse 550



Alliance 579

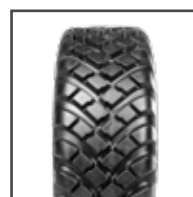

BKT Agrimax Turf RT 333

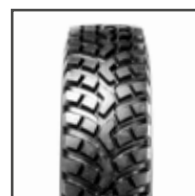

BKT Ridemax IT 696



Michelin CrossGrip



Nokian Hakkapeliitta TRI

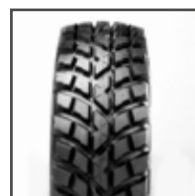

Nokian TRI 2





Kommunalreifen

Preise und Bestände finden Sie unter www.bohnenkamp.de/shop

Artikel-Nr.	Größe	Last-/ Speed-Index	TL/ TT	Profil	Marke	Felge ¹	Breite in mm	Außen ø in mm
17426020	360/80 R 20	147 A8/143 D	TL	TRI 2	Nokian	11/10/12	357	1092
15226972	380/70 R 20	122 A8/122 B	TL	579	Alliance	12	380	1082
15726603	380/70 R 20	122 A8/122 B	TL	Agrimax Turf RT 333	BKT	12/11/13	380	1082
15284045	400/70 R 20	149 A8/149 B	TL	Multiuse 550	Alliance	13/12/14	404	1068
17427070	400/70 R 20	144 D	TL	Hakkapeliitta TRI	Nokian	13/12/14	400	1072
15284046	405/70 R 20	149 A8/149 B	TL	Multiuse 550	Alliance	13/12/14	404	1076
15284055	300/80 R 24	133 A8/128 D	TL	Multiuse 550	Alliance	10/9/11	295	1092
15775020	300/80 R 24	133 A8/128 D	TL	Ridemax IT 696	BKT	10	295	1090
17426100	300/80 R 24	133 A8/128 D	TL	TRI 2	Nokian	10/9/11	295	1090
15284057	340/80 R 24	140 A8/135 D	TL	Multiuse 550	Alliance	11/10/12	343	1154
15775030	340/80 R 24	140 A8/135 D	TL	Ridemax IT 696	BKT	11/10/12	343	1154
17426085	340/80 R 24	140 A8/135 D	TL	TRI 2	Nokian	11/10/12	343	1154
15226975	360/70 R 24	122 A8/122 B	TL	579	Alliance	11/10/12	360	1152
15726612	360/70 R 24	122 A8/122 B	TL	Agrimax Turf RT 333	BKT	11/10/12	357	1152
15284061	360/80 R 24	143 A8/138 D	TL	Multiuse 550	Alliance	11	357	1184
15775032	360/80 R 24	143 A8/138 D	TL	Ridemax IT 696	BKT	11/10/12	343	1186
13375320	360/80 R 24	150 A8/145 D	TL	CrossGrip	Michelin	12/11	365	1192
17426105	360/80 R 24	143 A8/138 D	TL	TRI 2	Nokian	11/12/13	357	1186
17427102	360/80 R 24	138 D	TL	Hakkapeliitta TRI	Nokian	11/10/12/13	357	1186
15226978	380/70 R 24	125 A8/125 B	TL	579	Alliance	12/11/13	380	1190
15726623	380/70 R 24	125 A8/125 B	TL	Agrimax Turf RT 333	BKT	12/11/13	380	1190
15284069	400/80 R 24	149 A8/144 D	TL	Multiuse 550	Alliance	13	404	1249
15284290	400/80 R 24	149 A8/144 D	TL	Multiuse Professional 551	Alliance	13/12/14	404	1250
15775040	400/80 R 24	149 A8/144 D	TL	Ridemax IT 696	BKT	13/12/14	404	1250
13375330	400/80 R 24	156 A8/151 D	TL	CrossGrip	Michelin	13/12/14	413	1240
17426145	400/80 R 24	149 A8/144 D	TL	TRI 2	Nokian	13/12/14	404	1250
17427010	400/80 R 24	149 A8/144 D	TL	TRI 2 Extreme Steel	Nokian	13/12/14	404	1250
17427108	400/80 R 24	144 D	TL	Hakkapeliitta TRI	Nokian	13/12/14	404	1250
15284074	420/65 R 24	151 A8/146 D	TL	Multiuse 550	Alliance	13	454	1156
15775043	420/65 R 24	151 A8/146 D	TL	Ridemax IT 696	BKT	13/15/14	418	1158
17426190	420/65 R 24	151 A8/146 D	TL	TRI 2	Nokian	13/12/14/15	418	1156
17427112	420/65 R 24	146 D	TL	Hakkapeliitta TRI	Nokian	13	418	1156
15226980	420/70 R 24	130 A8/130 B	TL	579	Alliance	13/12/14	418	1248
15726632	420/70 R 24	130 A8/130 B	TL	Agrimax Turf RT 333	BKT	13/12/14	418	1248
15284072	440/80 R 24	154 A8/149 D	TL	Multiuse 550	Alliance	14	441	1319
15284295	440/80 R 24	154 A8/149 D	TL	Multiuse Professional 551	Alliance	14/15	441	1314
15775042	440/80 R 24	154 A8/149 D	TL	Ridemax IT 696	BKT	14/13/15	441	1314
13375335	440/80 R 24	161 A8/156 D	TL	CrossGrip	Michelin	14/15	447	1314
17426185	440/80 R 24	154 A8/149 D	TL	TRI 2	Nokian	14/15	441	1314
17427012	440/80 R 24	154 A8/149 D	TL	TRI 2 Extreme Steel	Nokian	14/15	441	1314
17427120	440/80 R 24	149 D	TL	Hakkapeliitta TRI	Nokian	14/15	435	1294

¹ = empfohlene Felge / weitere zulässige Felgenbreiten

Alles auf einen Blick:

statischer Halbmesser in mm	Abrollumfang in mm	Tragfähigkeit in kg	km/h	Luftdruck in bar
495	3280	3075/2725	40/65	4,00
501	3236	1500	40/50	1,60
486	3213	1500	40/50	1,60
482	3197	3250	40/50	4,00
485	3231	2800	65	4,00
486	3205	3250	40/50	4,00
502	3262	2060/1800	40/65	3,20
501	3296	2060/1800	40/65	3,20
499	3292	2060/1800	40/65	3,20
528	3439	2500/2180	40/65	3,20
521	3444	2500/2180	40/65	3,20
532	3487	2500/2180	40/65	3,20
535	3440	1500	40/50	1,60
518	3409	1500	40/50	1,60
540	3545	2725/2360	40/65	3,20
537	3556	2725/2360	40/65	3,20
547	3610	3350/2900	40/65	4,00
542	3581	2725/2360	40/65	3,20
543	3600	2360	65	3,20
540	3546	1650	40/50	1,60
534	3538	1650	40/50	1,60
566	3730	3250/2800	40/65	3,20
572	3710	3250/2800	40/65	3,20
558	3760	3250/2800	40/65	3,20
567	3747	4000/3450	40/65	4,00
568	3764	3250/2800	40/65	3,20
568	3764	3250/2800	40/65	3,20
567	3770	2800	65	3,20
526	3463	3450/3000	40/65	4,00/3,20
530	3483	3450/3000	40/65	3,20
525	3493	3450/3000	40/65	4,00
525	3493	3000	65	4,00
563	3620	1900	40/50	1,60
557	3728	1900	40/50	1,60
593	3913	3750/3250	40/65	3,20
596	3942	3750/3250	40/65	3,20
590	3939	3750/3250	40/65	3,20
593	3977	4625/4000	40/65	4,00
596	3965	3750/3250	40/65	3,20
594	3952	3750/3250	40/65	3,20
585	3921	3250	65	3,20



Alliance Multiuse 550

Alliance Multiuse Professional 551

Alliance 579



BKT Ridemax IT 696

BKT Agrimax Turf RT 333

Michelin CrossGrip

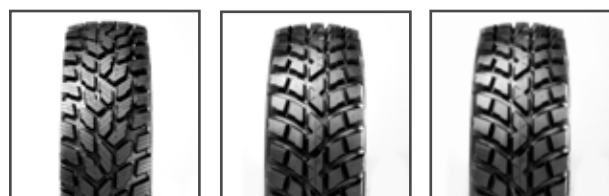

Nokian Hakkapeliitta TRI

Nokian TRI 2

Nokian TRI 2 Extreme Steel

ONLINE-SHOP-APP
Der gesamte Onlineshop für Tablet & Handy







Kommunalreifen

Preise und Bestände finden Sie unter www.bohnenkamp.de/shop

Artikel-Nr.	Größe	Last-/ Speed-Index	TL/ TT	Profil	Marke	Felge ¹	Breite in mm	Außen ø in mm
15284076	460/65 R 24	156 A8/151 D	TL	Multiuse 550	Alliance	14 /15/16	454	1209
15775044	460/65 R 24	156 A8/151 D	TL	Ridemax IT 696	BKT	14 /13/15	455	1214
17426200	460/65 R 24	156 A8/151 D	TL	TRI Steel	Nokian	13 /14/15	437	1185
17426195	460/65 R 24	156 A8/151 D	TL	TRI 2	Nokian	14 /15/16	454	1208
15284048	460/70 R 24	159 A8/159 B	TL	Multiuse 550	Alliance	15 /14/16	460	1250
15775045	460/70 R 24	157 A8/152 D	TL	Ridemax IT 697	BKT	15 /14/16	465	1254
17427226	460/70 R 24	161 D	TL	Hakkapeliitta TRI	Nokian	14 /15	460	1255
15284078	480/65 R 24	151 A8/146 D	TL	Multiuse 550	Alliance	15 /14/16	480	1240
17426210	480/65 R 24	151 A8/146 D	TL	TRI Steel	Nokian	14 /15/16	470	1240
15284051	500/70 R 24	164 A8/164 B	TL	Multiuse 550	Alliance	15 /16	505	1308
15775048	500/70 R 24	157 A8/152 D	TL	Ridemax IT 696	BKT	16 /15/18	503	1310
10000263	500/70 R 24	164 A8/159 D	TL	Ridemax IT 696	BKT	16 /15/18	503	1310
13375340	500/70 R 24	164 A8/159 D	TL	CrossGrip	Michelin	16 /15	513	1292
17427228	500/70 R 24	166 D	TL	Hakkapeliitta TRI	Nokian	16	500	1314
17426017	500/70 R 24	159 D	TL	TRI 2	Nokian	16 /15/18	503	1310
15284075	540/65 R 24	158 A8/154 D	TL	Multiuse 550	Alliance	15 /16/18	541	1312
17426212	540/65 R 24	158 A8/154 D	TL	TRI 2	Nokian	18 /16	550	1312
10001242	540/70 R 24	175 A8/170 D	TL	Ridemax IT 697	BKT	16 /18	535	1370
17427230	540/70 R 24	170 D	TL	Hakkapeliitta TRI	Nokian	18 /16	540	1367
15284079	480/80 R 26	160 A8/160 B	TL	Multiuse 550	Alliance	15 /16	483	1425
15226983	320/85 R 28	124 A8/124 B	TL	579	Alliance	10	328	1252
17426290	320/85 R 28	141 A8/136 D	TL	TRI 2	Nokian	10 /9/11	319	1250
15226987	340/85 R 28	127 A8/127 B	TL	579	Alliance	12	343	1289
15226990	360/70 R 28	125 A8/125 B	TL	579	Alliance	11	357	1251
17426270	360/80 R 28	146 A8/142 D	TL	TRI 2	Nokian	11 /12/13	357	1302
15284081	400/80 R 28	151 A8/146 D	TL	Multiuse 550	Alliance	13 /12/14	404	1352
15284300	400/80 R 28	151 A8/146 D	TL	Multiuse Professional 551	Alliance	13 /14	404	1355
15775050	400/80 R 28	151 A8/146 D	TL	Ridemax IT 696	BKT	13 /12/14	404	1352
17426275	400/80 R 28	151 A8/146 D	TL	TRI 2	Nokian	13 /12/14	404	1351
17427140	400/80 R 28	146 D	TL	Hakkapeliitta TRI	Nokian	13	404	1351
17427400	420/70 R 28	144 D/141 E	TL	Ground King	Nokian	13 /12/14	420	1349
15284086	440/80 R 28	156 A8/151 D	TL	Multiuse 550	Alliance	14 /15/16	440	1418
15284305	440/80 R 28	156 A8/151 D	TL	Multiuse Professional 551	Alliance	14 /15/16	440	1418
15775060	440/80 R 28	156 A8/151 D	TL	Ridemax IT 696	BKT	14 /15	441	1415
13375350	440/80 R 28	163 A8/158 D	TL	CrossGrip	Michelin	14 /15	450	1410
17426285	440/80 R 28	156 A8/151 D	TL	TRI 2	Nokian	14 /15/16	441	1415
17427020	440/80 R 28	156 A8/151 D	TL	TRI 2 Extreme Steel	Nokian	14 /15/16	441	1415
17427150	440/80 R 28	151 D	TL	Hakkapeliitta TRI	Nokian	14 /15/16	441	1415
15284090	480/65 R 28	154 A8/149 D	TL	Multiuse 550	Alliance	15 /14/16	475	1339
15775140	480/65 R 28	154 A8/149 D	TL	Ridemax IT 697	BKT	15	480	1335
17427402	480/65 R 28	148 D/145 E	TL	Ground King	Nokian	15 /14	480	1348

¹ = empfohlene Felge / weitere zulässige Felgenbreiten

Alles auf einen Blick:

 statischer Halbmesser in mm	 Abrollumfang in mm	 Tragfähigkeit in kg	 km/h	 Luftdruck in bar
547	3597	4000/3450	40/65	3,20
549	3644	4000/3450	40/65	3,20
545	3620	4000/3450	40/65	4,00
550	3638	4000/3450	40/65	4,00
568	3752	4375	40/50	4,00
571	3772	4125/3550	40/65	3,20
557	3792	4625	65	5,00
562	3726	3450/3000	40/65	3,20
565	3740	3450/3000	40/65	3,20
591	3920	5000	40/50	4,00
602	3954	4125/3550	40/65	3,20
602	3954	5000/4375	40/65	4,00
580	3998	5000/4375	40/65	4,00
580	3971	5300	65	5,00
585	3958	4375	65	4,00
592	3953	4250/3750	40/65	3,20
587	3952	4250/3750	40/65	3,20
625	4181	6900/6000	40/65	5,00
603	4143	6000	65	5,00
646	4266	4500	40/50	3,20
562	3741	1600	40/50	1,60
574	3782	2575/2240	40/65	3,20
607	3835	1750	40/50	1,60
575	3768	1650	40/50	1,60
595	3946	3000/2650	40/65	3,20
615	4039	3450/3000	40/65	3,20
620	4049	3450/3000	40/65	3,20
615	4048	3450/3000	40/65	3,20
620	4090	3450/3000	40/65	3,20
620	4090	3000	65	3,20
620	4102	2800/2575	65/70	3,20
646	4260	4000/3450	40/65	3,20
648	4240	4000/3450	40/65	3,20
634	4288	4000/3450	40/65	3,20
635	4283	4875/4250	40/65	4,00
644	4266	4000/3450	40/65	3,20
644	4266	4000/3450	40/65	3,20
640	4285	3450	65	3,20
607	4020	3750/3250	40/65	3,20
615	4088	3750/3250	40/65	3,20
617	4091	3150/2900	65/70	3,20

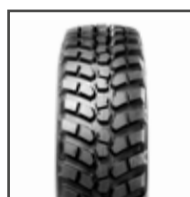

Alliance Multiuse 550



Alliance Multiuse Professional 551

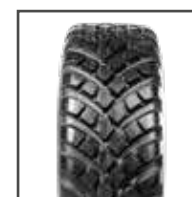

Alliance 579

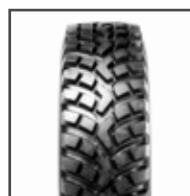

BKT Ridemax IT 696



BKT Ridemax IT 697



Michelin CrossGrip



Nokian Ground King

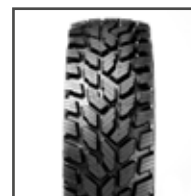

Nokian Hakkapeliitta TRI

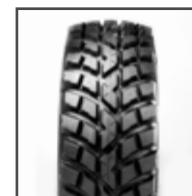

Nokian TRI 2

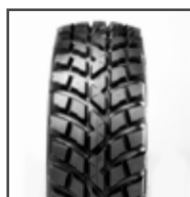

Nokian TRI 2 Extreme Steel



Nokian TRI Steel







Kommunalreifen

Preise und Bestände finden Sie unter www.bohnenkamp.de/shop

Artikel-Nr.	Größe	Last-/ Speed-Index	TL/ TT	Profil	Marke	Felge ¹	Breite in mm	Außen ø in mm
17426215	480/65 R 28	154 A8/149 D	TL	TRI 2	Nokian	15/14/16	479	1335
17427404	480/70 R 28	151 D/148 E	TL	Ground King	Nokian	15/14/16	480	1421
15226993	480/70 R 28	140 A8/140 B	TL	579	Alliance	15	479	1421
15284095	540/65 R 28	160 A8/155 D	TL	Multiuse 550	Alliance	18/16	550	1412
15775150	540/65 R 28	160 A8/155 D	TL	Ridemax IT 697	BKT	16/18	530	1413
17427408	540/65 R 28	154 D/151 E	TL	Ground King	Nokian	18/16	540	1413
17426220	540/65 R 28	160 A8/155 D	TL	TRI 2	Nokian	18/16	550	1413
15775063	600/65 R 28	165 A8/160 D	TL	Ridemax IT 697	BKT	18/20	591	1491
17427410	600/65 R 28	160 D/156 E	TL	Ground King	Nokian	20/18	600	1507
17427411	600/70 R 28	164 D/160 E	TL	Ground King	Nokian	20/18	610	1562
15284103	440/80 R 30	157 A8/153 D	TL	Multiuse 550	Alliance	14/13/15/16	434	1468
15775065	440/80 R 30	157 A8/153 D	TL	Ridemax IT 696	BKT	14/15	441	1466
17426405	440/80 R 30	157 A8/153 D	TL	TRI 2	Nokian	14/15/16	441	1466
15226996	480/70 R 30	141 A8/141 B	TL	579	Alliance	15	479	1478
15284098	480/80 R 30	162 A8/157 D	TL	Multiuse 550	Alliance	15/16/18	470	1531
15775070	480/80 R 30	162 A8/157 D	TL	Ridemax IT 696	BKT	15/16	479	1530
17426442	480/80 R 30	162 A8/157 D	TL	TRI 2	Nokian	15/16/18	479	1530
15284104	540/65 R 30	161 A8/156 D	TL	Multiuse 550	Alliance	18	550	1464
15284320	540/65 R 30	161 A8/156 D	TL	Multiuse Professional 551	Alliance	18/16	545	1464
15775200	540/65 R 30	161 A8/156 D	TL	Ridemax IT 697	BKT	16/18	530	1464
17427412	540/65 R 30	155 D/152 E	TL	Ground King	Nokian	18/16	540	1464
17426450	540/65 R 30	161 A8/156 D	TL	TRI 2	Nokian	18/16	550	1464
17427160	540/65 R 30	156 D	TL	Hakkapeliitta TRI	Nokian	18/16	550	1464
17427312	580/65 B 30	161 B	TL	TRI Backhoe	Nokian	16/18/20	580	1516
15284102	600/70 R 30	161 A8/158 D	TL	Multiuse 550	Alliance	20/18	611	1602
15775210	600/70 R 30	171 A8/166 D	TL	Ridemax IT 697	BKT	18/20	600	1600
17427416	600/70 R 30	165 D/161 E	TL	Ground King	Nokian	20/18	600	1588
17426452	600/70 R 30	166 D	TL	TRI 2	Nokian	20/18	600	1566
15284106	440/80 R 34	159 A8/155 D	TL	Multiuse 550	Alliance	14/15/16	441	1568
15284325	440/80 R 34	159 A8/155 D	TL	Multiuse Professional 551	Alliance	14/15	440	1570
15775073	440/80 R 34	159 A8/155 D	TL	Ridemax IT 696	BKT	14/15	441	1567
17426465	440/80 R 34	159 A8/155 D	TL	TRI 2	Nokian	14/15/16	441	1568
17427170	440/80 R 34	155 D	TL	Hakkapeliitta TRI	Nokian	14/15/16	441	1568
15226999	480/70 R 34	143 A8/143 B	TL	579	Alliance	15/14/16	479	1580
15284111	480/80 R 34	164 A8/159 D	TL	Multiuse 550	Alliance	15	479	1632
15284330	480/80 R 34	164 A8/159 D	TL	Multiuse Professional 551	Alliance	15	468	1640
15775075	480/80 R 34	164 A8/159 D	TL	Ridemax IT 696	BKT	15/16	479	1632
17426485	480/80 R 34	164 A8/159 D	TL	TRI 2	Nokian	15/16/18	479	1632
17427030	480/80 R 34	164 A8/159 D	TL	TRI 2 Extreme Steel	Nokian	15/16/18	479	1632
17427172	480/80 R 34	159 D	TL	Hakkapeliitta TRI	Nokian	15/16/18	479	1632

¹ = empfohlene Felge / weitere zulässige Felgenbreiten

Alles auf einen Blick:

 statischer Halbmesser in mm	 Abrollumfang in mm	 Tragfähigkeit in kg	 km/h	 Luftdruck in bar
604	4040	3750/3250	40/65	3,20
642	4270	3450/3150	65/70	3,20
632	4210	2500	40/50	1,60
649	4266	4500/3875	40/65	3,20
642	4276	4500/3875	40/65	3,20
637	4244	3750/3450	65/70	3,20
641	4273	4500/3875	40/65	3,20
684	4509	5150/4500	40/65	3,20
682	4564	4500/4000	65/70	3,20
708	4756	5000/4500	65/70	3,20
666	4436	4125/3650	40/65	3,20
668	4456	4125/3650	40/65	3,20
670	4430	4125/3650	40/65	3,20
669	4420	2575	40/50	1,60
695	4615	4750/4125	40/65	3,20
673	4558	4750/4125	40/65	3,20
694	4631	4750/4125	40/65	3,20
678	4481	4625/4000	40/65	3,20
674	4413	4625/4000	40/65	3,20
661	4434	4625/4000	40/65	3,20
672	4481	3875/3550	65/70	3,20
667	4417	4625/4000	40/65	3,20
665	4430	4000	65	3,20
698	4530	4625	50	3,20
727	4792	4625/4250	40/65	2,40
688	4820	6150/5300	40/65	3,20
714	4820	5150/4625	65/70	3,20
702	4756	5300	65	3,20
717	4739	4375/3875	40/65	3,20
723	4746	4375/3875	40/65	3,20
704	4775	4375/3875	40/65	3,20
717	4750	4375/3875	40/65	3,20
718	4763	3875	65	3,20
723	4715	2725	40/50	1,60
739	4912	5000/4375	40/65	3,20
753	4955	5000/4375	40/65	3,20
728	4894	5000/4375	40/65	3,20
743	4939	5000/4375	40/65	3,20
743	4939	5000/4375	40/65	3,20
744	4970	4375	65	3,20

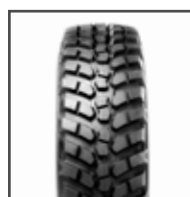

Alliance Multiuse 550



Alliance Multiuse Professional 551

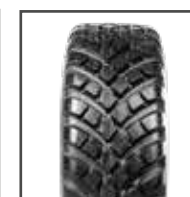

Alliance 579

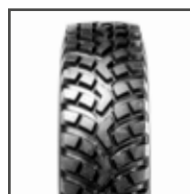

BKT Ridemax IT 696



BKT Ridemax IT 697



Nokian Ground King



Nokian Hakkapeliitta TRI

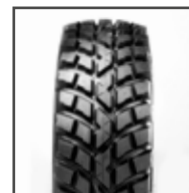

Nokian TRI 2

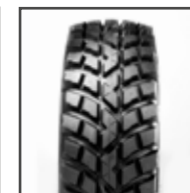

Nokian TRI 2 Extreme Steel







Kommunalreifen

Preise und Bestände finden Sie unter www.bohnenkamp.de/shop

Artikel-Nr.	Größe	Last-/ Speed-Index	TL/ TT	Profil	Marke	Felge ¹	Breite in mm	Außen ø in mm
17427420	600/65 R 34	163 D/159 E	TL	Ground King	Nokian	20/18	600	1649
17426490	600/65 R 34	164 D	TL	TRI 2	Nokian	20/18	600	1619
17427422	600/70 R 34	167 D/163 E	TL	Ground King	Nokian	20/18	600	1704
17427424	650/65 R 34	167 D/164 E	TL	Ground King	Nokian	20	650	1700
15284149	480/80 R 38	166 A8/161 D	TL	Multiuse 550	Alliance	15/16	479	1728
15775085	480/80 R 38	166 A8/161 D	TL	Ridemax IT 696	BKT	15/16	479	1733
13375380	480/80 R 38	166 A8/161 D	TL	CrossGrip	Michelin	15	480	1751
17426755	480/80 R 38	166 A8/161 D	TL	TRI 2	Nokian	15/16/18	479	1733
17427040	480/80 R 38	166 A8/161 D	TL	TRI 2 Extreme Steel	Nokian	15/16/18	479	1733
17427190	480/80 R 38	161 D	TL	Hakkapeliitta TRI	Nokian	15	479	1733
17427430	520/70 R 38	160 D/157 E	TL	Ground King	Nokian	16/18	520	1749
15284162	540/80 R 38	172 A8/167 D	TL	Multiuse 550	Alliance	18	546	1824
15775088	540/80 R 38	172 A8/167 D	TL	Ridemax IT 696	BKT	18/16	550	1829
17426855	540/80 R 38	172 A8/167 D	TL	TRI 2	Nokian	18/16	550	1829
17427050	540/80 R 38	172 A8/167 D	TL	TRI 2 Extreme Steel	Nokian	18/16	550	1829
17427110	540/80 R 38	167 D	TL	Hakkapeliitta TRI	Nokian	18/16	550	1829
17427434	580/70 R 38	166 D/163 E	TL	Ground King	Nokian	18	580	1829
15284170	600/65 R 38	170 A8/166 D	TL	Multiuse 550	Alliance	18/20	593	1749
15775224	600/65 R 38	170 A8/166 D	TL	Ridemax IT 697	BKT	18/20	590	1745
17427435	600/65 R 38	165 D/161 E	TL	Ground King	Nokian	20/18	600	1745
17426230	600/65 R 38	170 A8/166 D	TL	TRI 2	Nokian	18/20	591	1745
15284175	650/65 R 38	175 A8/170 D	TL	Multiuse 550	Alliance	20/18/23	645	1814
15775230	650/65 R 38	175 A8/170 D	TL	Ridemax IT 697	BKT	20/18	645	1811
17427432	650/65 R 38	169 D/166 E	TL	Ground King	Nokian	20	645	1811
17426235	650/65 R 38	175 A8/170 D	TL	TRI 2	Nokian	20/18/23	645	1811
15284147	650/85 R 38	181 A8/177 D	TL	Multiuse 550	Alliance	23/20/21	673	2067
15775235	650/85 R 38	183 A8/178 D	TL	Ridemax IT 697	BKT	23/20/21	709	2071
17427440	650/85 R 38	178 D/175 E	TL	Ground King	Nokian	23/20/21	650	2066
15775240	710/70 R 38	182 A8/177 D	TL	Ridemax IT 697	BKT	23/25	716	1959
17427438	710/70 R 38	177 D/174 E	TL	Ground King	Nokian	23	710	1953
15775280	540/80 R 42	173 A8/168 D	TL	Ridemax IT 696	BKT	18/16	560	1931
15284205	620/80 R 42	181 A8/177 D	TL	Multiuse 550	Alliance	20	625	2055
17426960	620/80 R 42	181 A8/177 D	TL	TRI 2	Nokian	20/21/23	625	2059
15284181	650/65 R 42	176 A8/171 D	TL	Multiuse 550	Alliance	20	645	1913
15284350	650/65 R 42	176 A8/171 D	TL	Multiuse Professional 551	Alliance	20/18	635	1913
15775250	650/65 R 42	174 A8/171 D	TL	Ridemax IT 697	BKT	20/18	645	1920
17426950	650/65 R 42	176 A8/171 D	TL	TRI 2	Nokian	20/18/23	645	1913
17427210	650/65 R 42	171 D	TL	Hakkapeliitta TRI	Nokian	20/18	645	1913
17427436	650/65 R 42	170 D/167 E	TL	Ground King	Nokian	20	645	1913
15284195	710/70 R 42	181 A8/177 D	TL	Multiuse 550	Alliance	23	716	2053
15775270	710/70 R 42	185 A8/180 D	TL	Ridemax IT 697	BKT	23	716	2068
17427442	710/70 R 42	179 D/175 E	TL	Ground King	Nokian	23/25	710	2059
17426970	710/70 R 42	180 D	TL	TRI 2	Nokian	23	710	2045
17427444	710/75 R 42	181 D/178 E	TL	Ground King	Nokian	23	710	2132

¹ = empfohlene Felge / weitere zulässige Felgenbreiten

Alles auf einen Blick:

 statischer Halbmesser in mm	 Abrollumfang in mm	 Tragfähigkeit in kg	 km/h	 Luftdruck in bar
751	5016	4875/4375	65/70	3,20
736	4935	5000	65	3,20
771	5170	5450/4875	65/70	3,20
769	5173	5450/5000	65/70	3,20
784	5202	5300/4625	40/65	3,20
780	5213	5300/4625	40/65	3,20
791	5272	5300/4625	40/65	3,20
793	5265	5300/4625	40/65	3,20
788	5253	5300/4625	40/65	3,20
793	5265	4625	65	3,20
803	5342	4500/4125	65/70	3,20
835	5503	6300/5450	40/65	3,20
833	5537	6300/5450	40/65	3,20
834	5529	6300/5450	40/65	3,20
834	5529	6300/5450	40/65	3,20
832	5566	5450	65	3,20
835	5574	5300/4875	65/70	3,20
793	5270	6000/5300	40/65	3,20
795	5315	6000/5300	40/65	3,20
798	5321	5150/4625	65/70	3,20
790	5290	6000/5300	40/65	3,20
818	5445	6900/6000	40/65	3,20
823	5514	6900/6000	40/65	3,20
827	5540	5800/5300	65/70	3,20
819	5510	6900/6000	40/65	3,20
913	6230	8250/7300	40/65	2,40
974	6280	8750/7500	40/65	3,20
933	6272	7500/6900	65/70	3,20
900	5950	8500/7300	40/65	3,20
884	5934	7300/6700	65/70	3,20
879	5875	6500/5600	40/65	3,20
948	6201	8250/7300	40/65	3,20
934	6262	8250/7300	40/65	3,20
871	5766	7100/6150	40/65	3,20
881	5779	7100/6150	40/65	3,20
880	5869	6700/6150	40/65	3,20
873	5799	7100/6150	40/65	3,20
871	5836	6150	65	3,20
872	5811	6000/5450	65/70	3,20
939	6187	8250/7300	40/65	2,80
926	6264	9250/8000	40/65	3,20
933	6245	7750/6900	65/70	3,20
923	6255	8000	65	3,20
964	6476	8250/7500	65/70	3,20

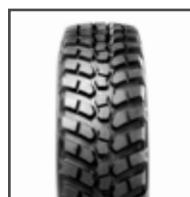

Alliance Multiuse 550



Alliance Multiuse Professional 551

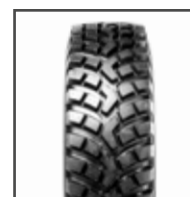

BKT Ridemax IT 696



BKT Ridemax IT 697

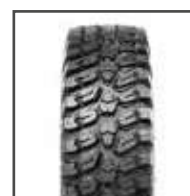

Michelin CrossGrip



Nokian Ground King

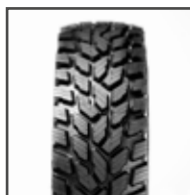

Nokian Hakkapeliitta TRI

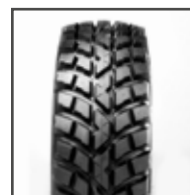

Nokian TRI 2

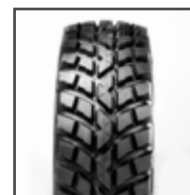

Nokian TRI 2 Extreme Steel



124

Forstreifen

130

Forstreifen Flotation



FORSTREIFEN

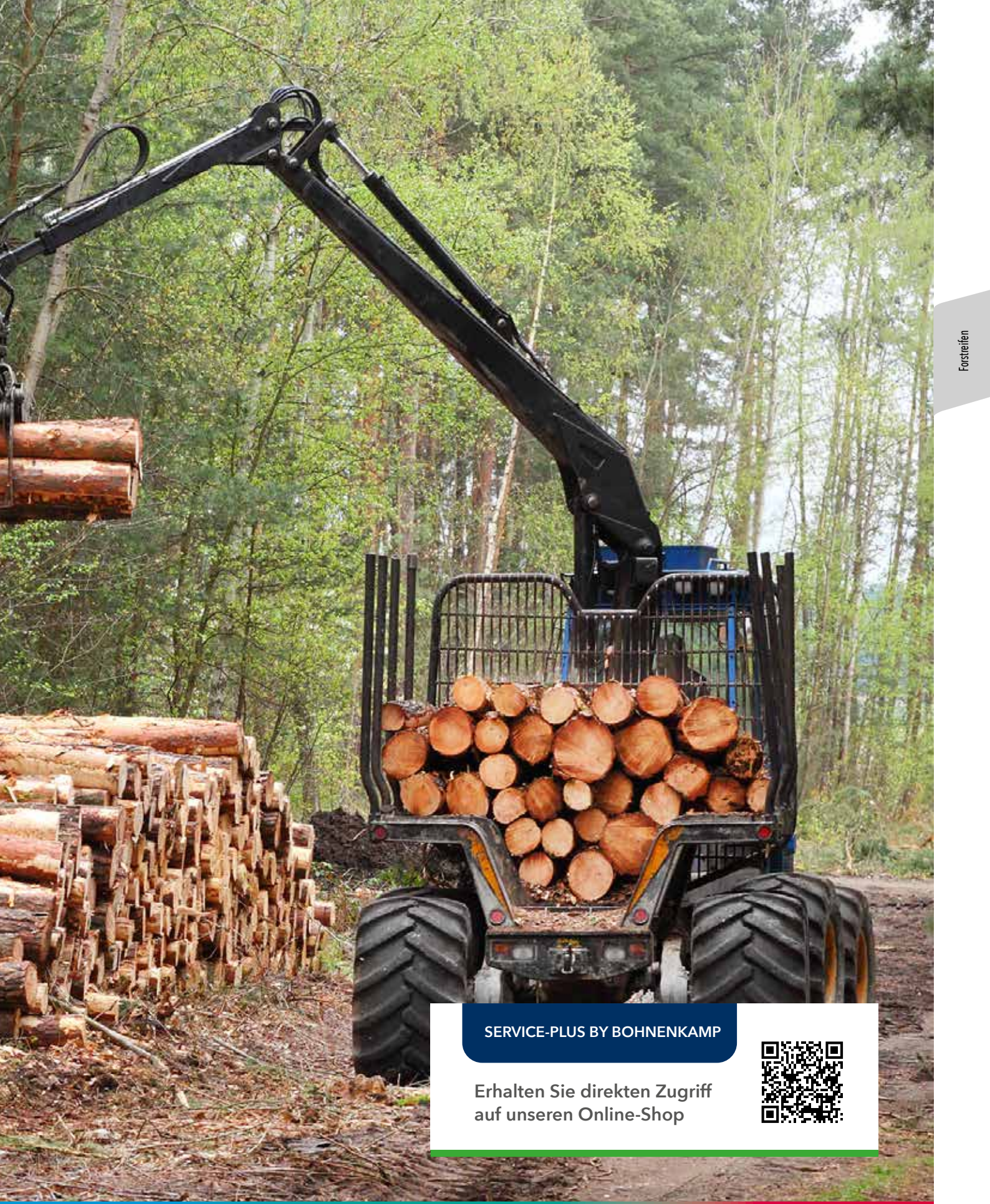

SERVICE-PLUS BY BOHNENKAMP

Erhalten Sie direkten Zugriff
auf unseren Online-Shop









Forstreifen

Preise und Bestände finden Sie unter www.bohnenkamp.de/shop

Artikel-Nr.	Größe	Last-/ Speed-Index	PR	TL/ TT	Profil	Marke	Felge ¹	Breite in mm	Außen ø in mm
15222182	11.2 - 24	125 A2/119 A8	10 PR	TL	Forestry 356	Alliance	10	290	1112
15222195	12.4 - 24	136 A2/128 A8	12 PR	TL	Forestry 356	Alliance	11/10	315	1145
15223303	320/85 - 24	127 A8/124 B	14 PR	TL	Agro Forestry 333	Alliance	11/10	320	1160
17422820	320/85 - 24	130 A8/127 B	16 PR	TL	TR Forest 2	Nokian	11/10	326	1174
15222198	13.6 - 24	136 A2/128 A8	10 PR	TL	Forestry 356	Alliance	12/11	345	1190
17422821	340/85 - 24	134 A8/131 B	16 PR	TL	TR Forest 2	Nokian	12/11	348	1223
15223050	380/70 - 24	138 A2/130 A8	14 PR	TL	Agro Forestry 370	Alliance	12/11/13	380	1206
15223305	380/85 - 24	137 A8/134 B	14 PR	TL	Agro Forestry 333	Alliance	12/11	380	1260
17422822	380/85 - 24	140 A8/137 B	16 PR	TL	TR Forest 2	Nokian	13/11/12	390	1266
15223060	420/70 - 24	145 A2/138 A8	14 PR	TL	Agro Forestry 370	Alliance	13/12	418	1265
15222240	480/65 - 24	147 A2/140 A8		TL	Forestry 360	Alliance	15/14	470	1250
17426160	500/65 R 24	142 A8/139 B		TL	TR Multiplus	Nokian	15/13/14/16	480	1244
15222373	23.1 - 26	172 A2/160 A6	16 PR	TL	Forestar 345	Alliance	20	587	1610
15722232	23.1 - 26	172 A2/160 A6	16 PR	TT	FS 216	BKT	20	587	1615
17421910	23.1 - 26	160 A6	16 PR	TL	Logger King LS-2	Nokian	20	587	1632
15222388	28L - 26	177 A2/165 A6	20 PR	TL	Forestar 345	Alliance	25	715	1638
15222387	28L - 26	184 A2/173 A6	26 PR	TL	Forestar 345	Alliance	25	715	1638
17421920	28L - 26	165 A6	20 PR	TL	Logger King LS-2	Nokian	25	714	1644
15222451	13.6 - 28	138 A2/130 A8	10 PR	TL	Forestry 356	Alliance	12	345	1295
17422823	340/85 - 28	136 A8/133 B	16 PR	TL	TR Forest 2	Nokian	12/11	352	1308
15223080	380/70 - 28	145 A2/138 A8	14 PR	TL	Agro Forestry 370	Alliance	12/11/13	380	1308
15223320	380/85 - 28	139 A8/136 B	14 PR	TL	Agro Forestry 333	Alliance	12	380	1368
17422824	380/85 - 28	142 A8/139 B	16 PR	TL	TR Forest 2	Nokian	13/11/12	392	1359
15223090	420/70 - 28	147 A2/140 A8	14 PR	TL	Agro Forestry 370	Alliance	13/12/14	418	1364
15222487	480/65 - 28	149 A2/142 A8		TL	Forestry 360	Alliance	15/14	460	1350
17426600	480/65 R 28	148 D		TL	Tractor King	Nokian	15/14/16/18	487	1359
17426620	500/65 R 28	150 D		TL	Tractor King	Nokian	16/15/18	503	1361
17426300	500/65 R 28	144 A8/141 B		TL	TR Multiplus	Nokian	15/13/14/16	480	1347
15222553	16.9 - 28	152 A2/145 A8	14 PR	TL	Forestry 356	Alliance	15/14	429	1420
15223330	420/85 - 28	144 A8/141 B	14 PR	TL	Agro Forestry 333	Alliance	15/14	430	1425
17422825	420/85 - 28	148 A8/145 B	16 PR	TL	TR Forest 2	Nokian	15/14/13	435	1423
15223100	480/70 - 28	152 A2/145 A8	14 PR	TL	Agro Forestry 370	Alliance	15	479	1448
15222557	540/65 - 28	162 A2/155 A8	16 PR	TL	Forestry 360	Alliance	16/15	520	1448
17426340	540/65 R 28	149 A8/146 B		TL	TR Multiplus	Nokian	16/15/18	540	1413
17426630	540/65 R 28	154 D		TL	Tractor King	Nokian	18/16	550	1413
15226749	600/60 R 28	167 A2/159 A8		TL	Forestar 342	Alliance	20/18	616	1420
17426610	600/60 R 28	157 D		TL	Tractor King	Nokian	18/20	601	1431
15222559	600/65 R 28	154 A8		TL	Forestry 360	Alliance	20/18	600	1480

¹ = empfohlene Felge / weitere zulässige Felgenbreiten

Alles auf einen Blick:

 statischer Halbmesser in mm	 Abrollumfang in mm	 Tragfähigkeit in kg	 km/h	 Luftdruck in bar
518	3346	1650/1360	10/40	3,00
524	3407	2240/1800	10/40	3,50
529	3445	1750/1600	40/50	2,40
529	3534	1900/1750	40/50	2,80
542	3603	2240/1800	10/40	2,50
552	3682	2120/1950	40/50	2,80
558	3614	2360/1900	10/40	2,70
570	3723	2300/2120	40/50	2,40
566	3813	2500/2300	40/50	2,80
582	3774	2900/2360	10/40	3,00
582	3702	3075/2500	10/40	2,40
575	3735	2650/2430	40/50	2,40
734	4781	6300/4500	10/30	2,40
726	4780	6300/4500	10/30	2,40
736	4863	6300/4500	10/30	2,80/2,40
746	4861	7300/5150	10/30	2,40
746	4861	9000/6500	10/30	3,90/3,60
733	4932	7250/5150	10/30	2,80/2,40
595	3863	2360/1900	10/40	2,50
591	3947	2240/2060	40/50	2,80
609	3935	2900/2360	10/40	3,00
623	4060	2430/2240	40/50	2,40
613	4107	2650/2430	40/50	2,80
633	4095	3075/2500	10/40	2,50
634	4088	3250/2650	10/40	2,40
629	4103	3150	65	3,20
629	4103	3350	65	3,20
622	4055	2800/2575	40/50	2,40
645	4207	3550/2900	10/40	2,70
670	4313	2800/2575	40/50	2,40
639	4310	3150/2900	40/50	2,80
668	4334	3550/2900	10/40	2,70
668	4331	4750/3875	10/40	3,30
653	4254	3250/3000	40/50	2,40
650	4248	3750	65	3,20
660	4335	5450/4375	10/40	3,20
617	4255	4125	65	3,20
684	4481	3750	40	2,40



Alliance Agro
Forestry 333



Alliance Agro
Forestry 370



Alliance
Forestar 342



Alliance
Forestar 345



Alliance
Forestry 356

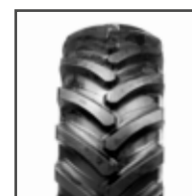

Alliance
Forestry 360



BKT FS 216



Nokian
Logger King LS-2



Nokian Tractor King

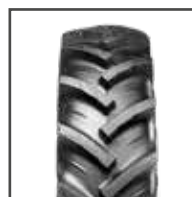

Nokian TR Forest 2

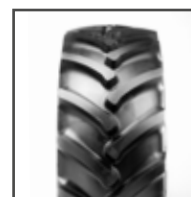

Nokian TR Multiplus









Forstreifen

Preise und Bestände finden Sie unter www.bohnenkamp.de/shop

Artikel-Nr.	Größe	Last-/ Speed-Index	PR	TL/ TT	Profil	Marke	Felge ¹	Breite in mm	Außen ø in mm
1522333	420/85 - 30	145 A8/142 B	14 PR	TL	Agro Forestry 333	Alliance	15/13/14	440	1475
15222573	420/85 - 30	150 A6	16 PR	TT	Forestar 345	Alliance	15	429	1504
17422826	420/85 - 30	149 A8/146 B	16 PR	TL	TR Forest 2	Nokian	15/13/14	430	1490
15222595	540/65 - 30	157 A2/150 A8		TL	Forestry 360	Alliance	16/18	525	1490
17426638	540/65 R 30	155 D		TL	Tractor King	Nokian	18/16	550	1464
15222589	18.4 - 30	158 A2/151 A8	14 PR	TL	Forestry 356	Alliance	16/15	467	1545
15223334	460/85 - 30	150 A8	14 PR	TL	Agro Forestry 333	Alliance	16/14/15	460	1550
15222600	540/70 - 30	159 A2/152 A8		TL	Forestry 360	Alliance	16/18	520	1502
17426640	540/70 R 30	159 D		TL	Tractor King	Nokian	16/18	540	1518
17426642	600/70 R 30	165 D		TL	Tractor King	Nokian	18/20	591	1602
17426644	620/75 R 30	169 D		TL	Tractor King	Nokian	20	625	1692
15222696	24.5 - 32	181 A2/169 A6	20 PR	TL	Forestar 345	Alliance	21	622	1817
17421950	24.5 - 32	169 A6	20 PR	TL	Logger King LS-2	Nokian	21	622	1831
15722580	30.5L - 32	166 A6	16 PR	TL	FS 216	BKT	27	775	1847
17421960	30.5L - 32	170 A6	20 PR	TL	Logger King LS-2	Nokian	27	775	1847
17421965	30.5L - 32	176 A6	26 PR	TL	Logger King LS-2	Nokian	27	775	1847
17421970	35.5L - 32	183 A6	26 PR	TL	Logger King LS-2	Nokian	31	902	2011
15222725	16.9 - 34	153 A2/146 A8	14 PR	TL	Forestry 356	Alliance	15/14	429	1575
15223336	420/85 - 34	147 A8/144 B	14 PR	TL	Agro Forestry 333	Alliance	15/13/14	430	1580
17422827	420/85 - 34	151 A8/148 B	16 PR	TL	TR Forest 2	Nokian	15/13/14	429	1577
15223160	480/70 - 34	153 A2/146 A8	14 PR	TL	Agro Forestry 370	Alliance	15/14/16	479	1600
15223340	460/85 - 34	152 A8/149 B	14 PR	TL	Agro Forestry 333	Alliance	16	460	1646
15222737	460/85 - 34	154 A6	16 PR	TT	Forestar 345	Alliance	16	467	1656
17422828	460/85 - 34	155 A8/152 B	16 PR	TL	TR Forest 2	Nokian	16/15	465	1638
15226815	600/65 R 34	172 A2/165 A8		TL	Forestar 342	Alliance	20	610	1642
17426650	600/65 R 34	163 D		TL	Tractor King	Nokian	18/20	591	1644
17426652	600/70 R 34	167 D		TL	Tractor King	Nokian	18/20	591	1704
15226797	710/55 R 34	178 A2/171 A8		TL	Forestar 342	Alliance	24	720	1644
15223347	420/85 - 38	149 A8/146 B	14 PR	TL	Agro Forestry 333	Alliance	15/13/14	430	1680
17422829	420/85 - 38	152 A8/149 B	16 PR	TL	TR Forest 2	Nokian	15/14/13	431	1673
15223190	480/70 - 38	157 A2/150 A8	14 PR	TL	Agro Forestry 370	Alliance	15/16/14	479	1715
15222801	540/65 - 38	160 A2/153 A8		TL	Forestry 360	Alliance	16/18	518	1699
15223350	460/85 - 38	154 A8/151 B	14 PR	TL	Agro Forestry 333	Alliance	16	460	1747
17422830	460/85 - 38	157 A8/154 B	16 PR	TL	TR Forest 2	Nokian	16/15	471	1740
15223200	520/70 - 38	162 A2/155 A8	14 PR	TL	Agro Forestry 370	Alliance	16/18	520	1758
15222813	600/65 - 38	166 A2/159 A8		TL	Forestry 360	Alliance	16/18/20	557	1760
17426660	600/65 R 38	165 D		TL	Tractor King	Nokian	18/20	591	1745
17426800	600/65 R 38	159 A8/156 B		TL	TR Multiplus	Nokian	18/16/20	575	1753
15223360	520/85 - 38	160 A8/157 B	14 PR	TL	Agro Forestry 333	Alliance	16/18	520	1860
17422831	520/85 - 38	164 A8/160 B	16 PR	TL	TR Forest 2	Nokian	18/16	536	1832

¹ = empfohlene Felge / weitere zulässige Felgenbreiten

Alles auf einen Blick:

 statischer Halbmesser in mm	 Abrollumfang in mm	 Tragfähigkeit in kg	 km/h	 Luftdruck in bar
672	4376	2900/2650	40/50	2,40
696	4508	3350	30	3,25
668	4482	3250/3000	40/50	2,80
692	4483	4125/3350	10/40	2,40
677	4427	3875	65	3,20
712	4618	4250/3450	10/40	2,60
702	4584	3350	40	2,40
693	4510	4375/3550	10/40	2,40
693	4539	4375	65	3,20
730	4826	5150	65	3,20
770	5097	5800	65	3,20
833	5414	8250/5800	10/30	2,70
835	5454	8200/5800	10/30	3,10/2,80
833	5466	5300	30	1,70
824	5529	8400/6000	10/30	2,40/2,10
823	5523	10000/7100	10/30	3,10/2,80
902	6032	12250/8750	10/30	2,80/2,40
722	4693	3650/3000	10/40	2,50
724	4705	3075/2800	40/50	2,40
707	4744	3450/3150	40/50	2,80
744	4812	3650/3000	10/40	2,50
751	4888	3550/3250	40/50	2,40
772	4972	3750	30	2,75
756	4951	3875/3550	40/50	2,80
772	4992	6300/5150	10/40	4,00
754	4960	4875	65	3,20
775	5138	5450	65	3,20
770	4998	7500/6150	10/40	4,00
774	5021	3250/3000	40/50	2,40
759	5081	3875/3250	40/50	2,80
801	5170	4125/3350	10/40	2,70
793	5125	4500/3650	10/40	2,40
801	5206	3750/3450	40/50	2,40
785	5267	4125/3750	40/50	2,80
819	5292	4750/3875	10/40	2,50
819	5318	5300/4375	10/40	2,40
805	5282	5150	65	3,20
809	5290	4375/4000	40/50	2,40
847	5520	4500/4125	40/50	2,40
817	5524	5000/4500	40/50	2,80

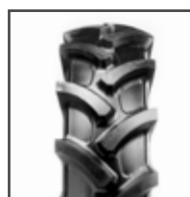

Alliance Agro Forestry 333

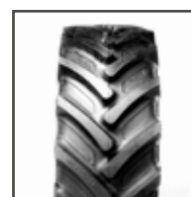

Alliance Agro Forestry 370



Alliance Forestar 342



Alliance Forestar 345

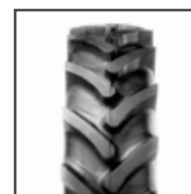

Alliance Forestry 356



Alliance Forestry 360



BKT FS 216



Nokian Logger King LS-2



Nokian Tractor King

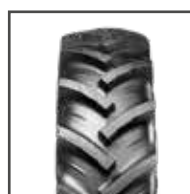

Nokian TR Forest 2

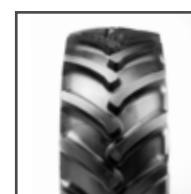

Nokian TR Multiplus



Forstreifen





Preise und Bestände finden Sie unter www.bohnenkamp.de/shop

Artikel-Nr.	Größe	Last-/ Speed-Index	PR	TL/ TT	Profil	Marke	Felge ¹	Breite in mm	Außen ø in mm
15223210	580/70 - 38	168 A2/160 A8	14 PR	TL	Agro Forestry 370	Alliance	18	570	1841
15222819	650/65 - 38	179 A2/171 A8	16 PR	TL	Forestar 342	Alliance	20/18	660	1840
15226796	650/65 R 38	178 A2/171 A8		TL	Forestar 342	Alliance	20	650	1812
17426820	650/65 R 38	164 A8/160 B		TL	TR Multiplus	Nokian	20/18	645	1811
17426670	650/65 R 38	169 D		TL	Tractor King	Nokian	20	645	1811
15222820	650/75 - 38	175 A2/168 A8		TL	Forestry 360	Alliance	21/20	680	1965
17426672	650/75 R 38	175 D		TL	Tractor King	Nokian	20/21/23	645	1941
15226809	710/70 R 38	175 A2/168 A8		TL	Forestry 360	Alliance	23	716	1940
17426674	650/85 R 38	178 D		TL	Tractor King	Nokian	20/21/23	645	2071
15223370	520/85 - 42	162 A8/159 B		TL	Agro Forestry 333	Alliance	16/18	520	1950
15226818	650/65 R 42	172 A2/165 A8		TL	Forestry 360	Alliance	20/18	655	1950
15225263	710/70 R 42	173 A8/173 B		TL	Forestry 365	Alliance	23	730	2050
17426680	710/70 R 42	179 D		TL	Tractor King	Nokian	23/25	716	2061
17426682	710/75 R 42	181 D		TL	Tractor King	Nokian	23/25	716	2133

¹ = empfohlene Felge / weitere zulässige Felgenbreiten



Alles auf einen Blick:

 statischer Halbmesser in mm	 Abrollumfang in mm	 Tragfähigkeit in kg	 km/h	 Luftdruck in bar
854	5528	5600/4500	10/40	2,50
850	5586	7750/6150	10/40	3,20
842	5521	7500/6150	10/40	3,60
838	5485	5000/4500	40/50	2,40
830	5479	5800	65	3,20
902	5850	6900/5600	10/40	2,40
925	5889	6900	65	3,20
898	5897	6900/5600	10/40	2,40
975	6267	7500	65	3,20
<hr/>				
905	5785	4750/4375	40/50	2,40
900	5869	6300/5150	10/40	2,40
956	6240	6500	40/50	3,00
975	6267	7750	65	3,20
972	6458	8250	65	3,20



Alliance Agro Forestry 333



Alliance Agro Forestry 370



Alliance Forestar 342



Alliance Forestry 360

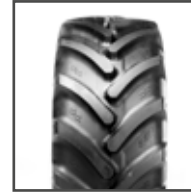

Alliance Forestry 365



Nokian Tractor King



Nokian TR Multiplus

Forstreifen









Forstreifen Flotation

Preise und Bestände finden Sie unter www.bohnenkamp.de/shop

Artikel-Nr.	Größe	Last-/ Speed-Index	PR	TL/ TT	Profil	Marke	Felge ¹	Breite in mm	Außen ø in mm
19111124	11.5/80 - 15.3	139 A8	14 PR	TL	Forestry 316	Deli	9.00	292	870
15212554	400/60 - 15.5	148 A8	16 PR	TL	Forestry 328	Alliance	13.00	404	864
15212556	400/60 - 15.5	152 A8	20 PR	TL	Forestry 328	Alliance	13.00	404	864
19111129	400/60 - 15.5	145 A8	14 PR	TL	Forestry 316	Deli	13.00	396	870
19111141	400/60 - 15.5	152 A8/140 A8	18 PR	TL	Forestry 802	Deli	13.00	400	874
15211657	500/60 - 15.5	157 A2/150 A8	12 PR	TL	Forestry 328	Alliance	16.00	503	994
15211701	500/55 - 17	155 A2/148 A8	12 PR	TL	Forestry 328	Alliance	16.00	503	980
15212592	550/45 - 22.5	147 A2/140 A8	12 PR	TL	Forestry 331	Alliance	16.00/20.00	550	1080
15212585	500/60 - 22.5	158 A2/151 A8	16 PR	TL	Forestry 331	Alliance	16.00	500	1170
15212631	600/50 - 22.5	156 A2/149 A8	16 PR	TL	Forestar 343	Alliance	20.00	585	1163
15212632	600/50 - 22.5	158 A2/151 A8	16 PR	TL	Forestar 344	Alliance	20.00	600	1170
15212629	600/50 - 22.5	167 A2/159 A8	20 PR	TT	Forestar 644 III	Alliance	20.00	600	1170
17416045	600/50 - 22.5	167 A2/159 A8	20 PR	TT	Forest King TRS 2	Nokian	20.00	600	1170
17416003	600/50 - 22.5	167 A2/159 A8	20 PR	TT	Forest King F2	Nokian	20.00	600	1170
17415024	600/50 - 22.5	156 A2/149 A8	16 PR	TT	Nordman Forest ELS L-2	Nokian	20.00	600	1171
17415026	600/50 - 22.5	156 A2/149 A8	16 PR	TT	Nordman Forest TRS L-2	Nokian	20.00	600	1171
15212664	710/40 - 22.5	159 A2/152 A8	16 PR	TL	Forestar 343	Alliance	24.00	710	1170
15212662	710/40 - 22.5	161 A2/154 A8	16 PR	TL	Forestar 344	Alliance	24.00	700	1170
17416005	710/40 - 22.5	168 A2/161 A8	20 PR	TT	Forest King F2	Nokian	24.00	710	1170
17416047	710/40 - 22.5	168 A2/161 A8	20 PR	TT	Forest King TRS 2	Nokian	24.00	710	1170
17415027	710/40 - 22.5	158 A2/151 A8	16 PR	TT	Nordman Forest TRS L-2	Nokian	24.00	710	1171
17415028	710/40 - 22.5	158 A2/151 A8	16 PR	TT	Nordman Forest F	Nokian	24.00	710	1171
17416048	600/50 - 24.5	171 A2/164 A8	20 PR	TT	Forest King TRS 2	Nokian	20.00	600	1230
15212679	650/45 - 24.5	168 A2/161 A8	20 PR	TL	Forestar 344	Alliance	22.00	640	1234
15212687	710/40 - 24.5	170 A2/163 A8	20 PR	TL	Forestar 343	Alliance	24.00	710	1235
15212685	710/40 - 24.5	170 A2/163 A8	20 PR	TL	Forestar 344	Alliance	24.00	710	1230
15212689	710/40 - 24.5	170 A2/163 A8	20 PR	TL	Forestar 344 ELIT	Alliance	24.00	710	1230
17416014	710/40 - 24.5	170 A2/163 A8	20 PR	TT	Forest King F2	Nokian	24.00	710	1230
17416050	710/40 - 24.5	170 A2/163 A8	20 PR	TT	Forest King TRS 2	Nokian	24.00	710	1230
17416022	800/40 - 24.5	176 A2/169 A8	20 PR	TT	Forest King F2	Nokian	28.00	786	1250
15212705	500/60 - 26.5	170 A2/163 A8	16 PR	TL	Forestry 331	Alliance	16.00	500	1270
15212743	600/55 - 26.5	172 A2/165 A8	20 PR	TL	Forestar 343	Alliance	20.00	600	1340
15212744	600/55 - 26.5	172 A2/165 A8	20 PR	TL	Forestar 344	Alliance	20.00	620	1340
15712830	600/55 - 26.5	172 A2/165 A8	20 PR	TL	Forestech	BKT	20.00	610	1335
17416010	600/55 - 26.5	172 A2/165 A8	20 PR	TT	Forest King F2	Nokian	20.00	601	1340
17416070	600/55 - 26.5	172 A2/165 A8	20 PR	TT	Forest King TRS 2	Nokian	20.00	600	1340
17415030	600/55 - 26.5	172 A2/165 A8	20 PR	TT	Nordman Forest TRS L-2	Nokian	20.00	600	1340
17415050	600/55 - 26.5	172 A2/165 A8	20 PR	TT	Nordman Forest F	Nokian	20.00	601	1340
10001041	600/55 - 26.5	172 A2/165 A8	20 PR	TT	T440	Trelleborg	20.00	600	1340
17412050	650/60 - 26.5	179 A2/172 A8	20 PR	TT	Forest King TRS L-2	Nokian	20.00	650	1485

¹ = empfohlene Felge / weitere zulässige Felgenbreiten

Alles auf einen Blick:

				
statischer Halbmesser in mm	Abrollumfang in mm	Tragfähigkeit in kg	km/h	Luftdruck in bar
382	2619	2430	40	4,75
380	2509	3150	40	4,00
380	2509	3550	40	5,00
370	2578	2900	40	3,60
374	2590	3550/2500	40	5,00
439	2894	4125/3350	10/40	3,30
441	2906	3875/3150	10/40	3,30
497	3230	3075/2500	10/40	2,40
540	3500	4250/3450	10/40	3,20
543	3562	4000/3250	10/40	3,20
540	3502	4250/3450	10/40	3,20
551	3602	5450/4375	10/40	5,00
533	3550	5450/4375	10/40	5,00
539	3544	5450/4375	10/40	5,00
543	3544	4000/3250	10/40	4,00
545	3544	4000/3250	10/40	3,20
546	3569	4375/3550	10/40	3,20
540	3502	4625/3750	10/40	3,60
537	3550	5600/4625	10/40	5,00
535	3569	5600/4625	10/40	5,00
539	3537	4250/3450	10/40	3,20
538	3544	4250/3450	10/40	4,00
566	3738	6150/5000	10/40	5,50
579	3720	5600/4625	10/40	5,00
582	3780	6000/4875	10/40	5,00
579	3828	6000/4875	10/40	5,00
560	3705	6000/4875	10/40	2,50
570	3738	6000/4875	10/40	5,00
570	3757	6000/4875	10/40	5,00
569	3795	7100/5800	10/40	5,00
590	3820	6000/4875	10/40	4,00
620	4068	6300/5150	10/40	5,00
619	4053	6300/5150	10/40	5,00
618	4032	6300/5150	10/40	5,00
618	4071	6300/5150	10/40	5,00
619	4096	6300/5150	10/40	5,00
616	4065	6300/5150	10/40	5,00
617	4084	6300/5150	10/40	5,00
626	4050	6300/5150	10/40	5,00
676	4467	7750/6300	10/40	5,00

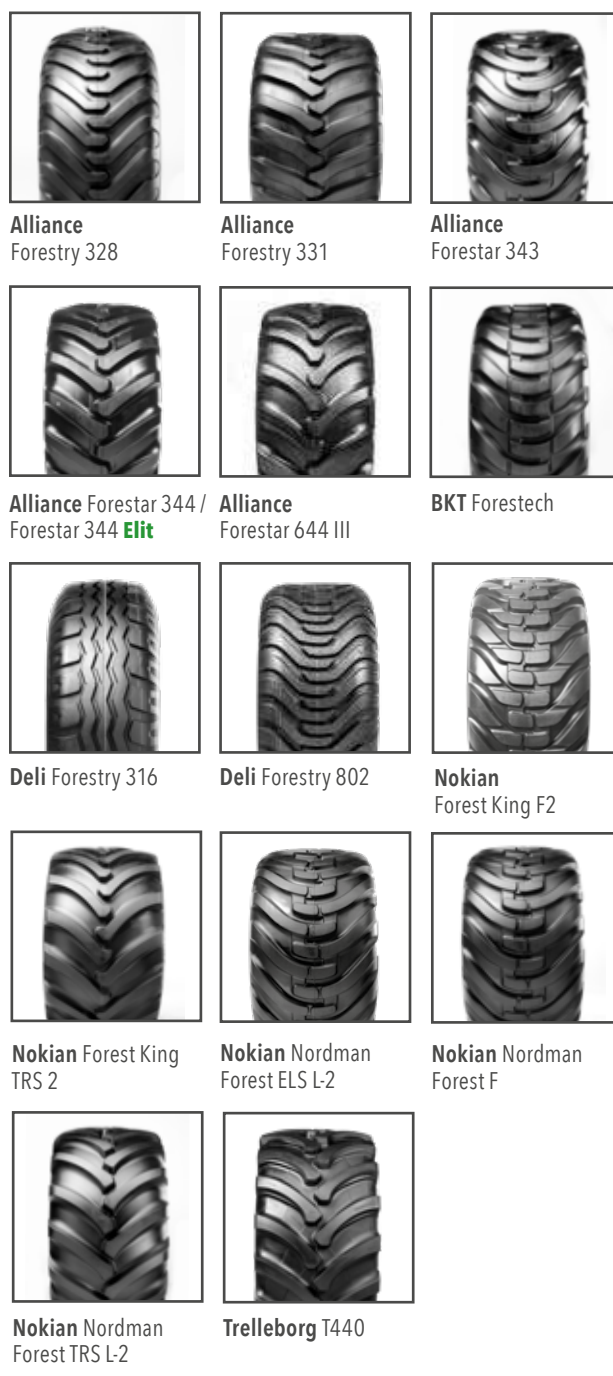

Forstreifen







Forstreifen Flotation

Preise und Bestände finden Sie unter www.bohnenkamp.de/shop

Artikel-Nr.	Größe	Last-/ Speed-Index	PR	TL/ TT	Profil	Marke	Felge ¹	Breite in mm	Außen ø in mm
15212747	650/65 - 26.5	181 A2/174 A8	20 PR	TL	Forestar 344	Alliance	20.00	650	1485
15212748	650/65 - 26.5	181 A2/174 A8	20 PR	TL	Forestar 343	Alliance	20.00	657	1485
15212760	710/45 - 26.5	175 A2/168 A8	20 PR	TL	Forestar 344	Alliance	24.00	710	1340
15212759	710/45 - 26.5	175 A2/168 A8	20 PR	TL	Forestar 344 ELIT	Alliance	24.00	710	1330
10000686	710/45 - 26.5	168 A8	20 PR	TT	Forestar 643 III	Alliance	24.00	695	1340
15212758	710/45 - 26.5	175 A2/168 A8	20 PR	TT	Forestar 644 III	Alliance	24.00	710	1340
15212761	710/45 - 26.5	175 A2/168 A8	20 PR	TL	Forestar 343	Alliance	24.00	710	1340
15215744	710/45 R 26.5	175 A2/168 A8		TL	Forestar 342	Alliance	24.00	714	1334
15712860	710/45 - 26.5	175 A2/168 A8	20 PR	TL	Forestech	BKT	24.00	710	1340
17416012	710/45 - 26.5	173 A2/168 A8	20 PR	TT	Forest King F2	Nokian	24.00	710	1340
17416060	710/45 - 26.5	175 A2/168 A8	20 PR	TT	Forest King TRS 2	Nokian	24.00	710	1340
17416013	710/45 - 26.5	180 A2/173 A8	24 PR	TT	Forest King F2	Nokian	24.00	710	1340
17416061	710/45 - 26.5	180 A2/173 A8	24 PR	TT	Forest King TRS 2	Nokian	24.00	710	1340
17415032	710/45 - 26.5	175 A2/168 A8	20 PR	TT	Nordman Forest TRS L-2	Nokian	24.00	710	1340
17415060	710/45 - 26.5	175 A2/168 A8	20 PR	TT	Nordman Forest F	Nokian	24.00	710	1340
15212849	750/55 - 26.5	184 A2/177 A8	20 PR	TL	Forestar 344	Alliance	24.00	750	1485
15212841	750/55 - 26.5	184 A2/177 A8	20 PR	TL	Forestar 344 ELIT	Alliance	24.00	750	1485
15212848	750/55 - 26.5	184 A2/177 A8	20 PR	TL	Forestar 343	Alliance	24.00	750	1485
15212843	750/55 - 26.5	189 A2/182 A8	24 PR	TT	Forestar 644 III	Alliance	24.00	750	1490
15712890	750/55 - 26.5	184 A2/177 A8	20 PR	TL	Forestech	BKT	23/25	755	1485
17416016	750/55 - 26.5	189 A2/182 A8	24 PR	TT	Forest King F2	Nokian	24.00	750	1485
17416062	750/55 - 26.5	189 A2/182 A8	24 PR	TT	Forest King TRS 2	Nokian	24.00	750	1485
17415052	750/55 - 26.5	184 A2/177 A8	20 PR	TT	Nordman Forest F	Nokian	24.00	750	1485
17415035	750/55 - 26.5	184 A2/177 A8	20 PR	TT	Nordman Forest TRS L-2	Nokian	24.00	750	1485
10001040	750/55 - 26.5	190 A2/182 A8	20 PR	TT	T440	Trelleborg	24.00	750	1485
15212850	800/40 - 26.5	177 A2/170 A8	20 PR	TL	Forestar 344	Alliance	28.00	800	1340
15212764	800/40 - 26.5	177 A2/170 A8	20 PR	TL	Forestar 344 ELIT	Alliance	28.00	800	1340
17416080	800/40 - 26.5	177 A2/170 A8	20 PR	TT	Forest King TRS 2	Nokian	28.00	800	1340
17416017	800/40 - 26.5	177 A2/170 A8	20 PR	TT	Forest King F2	Nokian	28.00	800	1340
10001039	800/40 - 26.5	177 A2/170 A8	20 PR	TT	T440	Trelleborg	28.00	800	1340
15212895	870/45 - 26.5	177 A2/170 A8	20 PR	TL	Forestar 344	Alliance	28.00	870	1430
17416064	710/55 - 28.5	187 A2/180 A8	24 PR	TT	Forest King TRS 2	Nokian	24.00	710	1525
17416018	710/55 - 28.5	187 A2/180 A8	24 PR	TT	Forest King F2	Nokian	24.00	710	1525
17416020	780/50 - 28.5	190 A2/182 A8	24 PR	TT	Forest King F2	Nokian	26.00	780	1525
17416066	780/50 - 28.5	190 A2/182 A8	24 PR	TT	Forest King TRS 2	Nokian	26.00	780	1525
15213513	600/60 - 30.5	175 A2/168 A8	20 PR	TL	Forestry 331	Alliance	20.00	600	1500
15213561	700/50 - 30.5	176 A2/169 A8	20 PR	TL	Forestry 331	Alliance	24.00	700	1510

¹ = empfohlene Felge / weitere zulässige Felgenbreiten

Alles auf einen Blick:

 statischer Halbmesser in mm	 Abrollumfang in mm	 Tragfähigkeit in kg	 km/h	 Luftdruck in bar
690	4502	8250/6700	10/40	5,00
690	4464	8250/6700	10/40	5,00
620	4016	6900/5600	10/40	5,00
602	3974	6900/5600	10/40	2,50
623	4126	5600	40	5,00
628	4098	6900/5600	10/40	5,50
620	4112	6900/5600	10/40	5,00
621	4113	6900/5600	10/40	5,00
620	4047	6900/5600	10/40	5,00
622	4084	6900/5600	10/40	5,00
618	4103	6900/5600	10/40	5,00
621	4084	8000/6500	10/40	6,00
617	4115	8000/6500	10/40	6,00
608	4077	6900/5600	10/40	5,00
622	4046	6900/5600	10/40	5,00
690	4554	9000/7300	10/40	5,00
664	4436	9000/7300	10/40	2,50
690	4536	9000/7300	10/40	5,00
683	4467	10300/8500	10/40	6,00
680	4467	9000/7300	10/40	5,00
674	4486	10300/8500	10/40	6,00
674	4499	10300/8500	10/40	6,00
680	4467	9000/7300	10/40	5,00
667	4474	9000/7300	10/40	5,00
690	4485	10600/8500	10/40	6,00
620	4016	7300/6000	10/40	4,50
600	3993	7300/6000	10/40	2,50
619	4096	7300/6000	10/40	5,00
620	4084	7300/6000	10/40	5,00
625	4020	7300/6000	10/40	5,00
666	4264	7300/6000	10/40	4,00
693	4618	9750/8000	10/40	6,00
696	4618	9750/8000	10/40	6,00
697	4618	10600/8500	10/40	6,00
691	4611	10600/8500	10/40	6,00
696	4504	6900/5600	10/40	4,00
699	4527	7100/5800	10/40	3,70

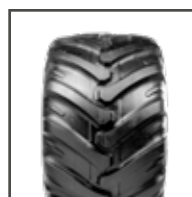

Alliance
Forestar 342



Alliance
Forestar 343

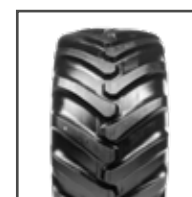

**Alliance Forestar 344 /
Forestar 344 **Elit****



Alliance
Forestar 643 III



Alliance
Forestar 644 III

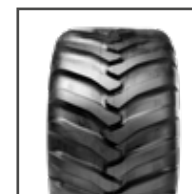

Alliance
Forestry 331

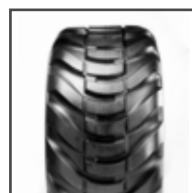

BKT Forestech



Nokian
Forest King F2

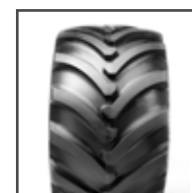

Nokian Forest King
TRS 2

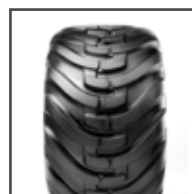

Nokian Nordman
Forest F



Nokian Nordman
Forest TRS L-2



Trelleborg T440





Forstreifen Flotation





Preise und Bestände finden Sie unter www.bohnenkamp.de/shop

Artikel-Nr.	Größe	Last-/ Speed-Index	PR	TL/ TT	Profil	Marke	Felge ¹	Breite in mm	Außen ø in mm
15222745	600/65 - 34	164 A2/157 A8	14 PR	TL	Forestar 346	Alliance	20	600	1640
17415020	600/65 - 34	170 A2/163 A8	20 PR	TT	Nordman Forest TRS L-2	Nokian	20	600	1644
17416110	600/65 - 34	176 A2/169 A8	24 PR	TT	Forest King TRS 2+	Nokian	20	615	1638
15222752	700/55 - 34	171 A2/164 A8	20 PR	TL	Forestar 346	Alliance	24	700	1650
17415010	700/55 - 34	173 A2/166 A8	20 PR	TT	Nordman Forest TRS L-2	Nokian	24	700	1630
17416114	710/55 - 34	180 A2/173 A8	24 PR	TT	Forest King TRS 2+	Nokian	24/23	715	1634
10001034	710/55 - 34	174 A2/167 A8	20 PR	TL	T440	Trelleborg	24	710	1650
15222757	700/70 - 34	180 A2/173 A8	20 PR	TL	Forestar 346	Alliance	20	721	1850
17415015	700/70 - 34	180 A2/173 A8	20 PR	TT	Nordman Forest TRS L-2	Nokian	20	700	1844
17416112	710/70 - 34	189 A2/181 A8	24 PR	TT	Forest King TRS 2+	Nokian	24/23	754	1833

¹ = **empfohlene Felge** / weitere zulässige Felgenbreiten



Alles auf einen Blick:

 statischer Halbmesser in mm	 Abrollumfang in mm	 Tragfähigkeit in kg	 km/h	 Luftdruck in bar
762	4927	5000/4125	10/40	2,40
755	4964	6000/4875	10/40	3,20
743	4964	7100/5800	10/40	4,00
766	5051	6150/5000	10/40	4,50
751	4938	6500/5300	10/40	3,20
740	4957	8000/6500	10/40	4,00
775	4950	6700/5450	10/40	3,20
863	5611	8000/6500	10/40	4,20
840	5542	8000/6500	10/40	3,20
819	5548	10300/8250	10/40	4,00

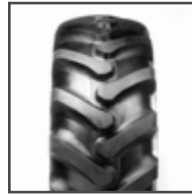

Alliance
Forestar 346



Nokian Forest King
TRS 2+



Nokian Nordman
Forest TRS L-2



Trelleborg T440

Forstreifen



138

Traktor Golf Rasenpflege



**TRAKTOR GOLF
RASENPFLEGE**



SERVICE-PLUS BY BOHNENKAMP

Erhalten Sie direkten Zugriff
auf unseren Online-Shop









Traktor Golf Rasenpflege

Preise und Bestände finden Sie unter www.bohnenkamp.de/shop

Artikel-Nr.	Größe	Last-/Speed-Index	PR	TL/TT	Profil	Marke	Felge ¹	Breite in mm	Außen ø in mm
15226930	220/55 R 12	82 A8/82 B		TL	579	Alliance	7.00	220	550
15226933	240/60 R 12	89 A8/89 B		TL	579	Alliance	8.00/7	240	592
15226940	200/60 R 15	83 A8/83 B		TL	579	Alliance	7	200	620
15226942	200/65 R 16	94 A8/94 B		TL	579	Alliance	6	198	666
15226945	200/70 R 16	94 A8/94 B		TL	579	Alliance	6	198	686
15226948	240/70 R 16	104 A8/104 B		TL	579	Alliance	8	245	740
15226950	260/70 R 16	109 A8/109 B		TL	579	Alliance	8/9	260	770
15726539	260/70 R 16	109 A8/109 B		TL	Agrimax Turf RT 333	BKT	8/9	258	770
15226953	280/70 R 16	112 A8/112 B		TL	579	Alliance	8/9/10	282	800
10691510	13.6 - 16	100 A6	4 PR	TT	PD1	Bridgestone	12	357	997
15226957	260/70 R 18	114 A8/114 B		TL	579	Alliance	8/9	258	821
15226963	280/70 R 18	114 A8/114 B		TL	579	Alliance	9	282	849
15226960	320/65 R 18	109 A8/106 B		TL	579	Alliance	10	310	873
15226966	300/70 R 20	110 A8/110 B		TL	579	Alliance	9	295	954
15726581	300/70 R 20	110 A8/110 B		TL	Agrimax Turf RT 333	BKT	9/10	295	955
15226970	320/70 R 20	113 A8/113 B		TL	579	Alliance	10	320	982
15726591	320/70 R 20	113 A8/113 B		TL	Agrimax Turf RT 333	BKT	10/9/11	319	982
10691830	355/80 - 20	111 A6	4 PR	TT	PD1	Bridgestone	11	345	1076
15226972	380/70 R 20	122 A8/122 B		TL	579	Alliance	12	380	1082
15726603	380/70 R 20	122 A8/122 B		TL	Agrimax Turf RT 333	BKT	11/10/12	357	1152
19800248	475/65 - 20	122 A6	4 PR	TT	PD1	Bridgestone	15	465	1126
15722105	11.2 - 24	116 A6/113 A8	8 PR	TL	TR 387	BKT	10/9	292	1075
12500840	310/75 - 24	106 A8	6 PR	TL	Turf Pro R-3	Carlisle	10.00/9/10	315	1077
15226975	360/70 R 24	122 A8/122 B		TL	579	Alliance	11/10/12	360	1152
15726612	360/70 R 24	122 A8/122 B		TL	Agrimax Turf RT 333	BKT	11/10/12	357	1152
15226978	380/70 R 24	125 A8/125 B		TL	579	Alliance	12/11/13	380	1190
15726623	380/70 R 24	125 A8/125 B		TL	Agrimax Turf RT 333	BKT	12/11/13	380	1190
15222206	14.9 - 24	123 A8	6 PR	TL	329	Alliance	13/12	394	1241
15722185	14.9 - 24	128 A6/124 A8	8 PR	TL	TR 391	BKT	13	405	1270
15226980	420/70 R 24	130 A8/130 B		TL	579	Alliance	13	418	1248
15726632	420/70 R 24	130 A8/130 B		TL	Agrimax Turf RT 333	BKT	13/12/14	418	1248
15222262	16.9 - 24	133 A8	8 PR	TL	329	Alliance	15	442	1309
15772442	18.4 - 26	146 A6	12 PR	TL	TR 387	BKT	16/15	475	1430
15222360	23.1 - 26	153 A8	12 PR	TL	329	Alliance	20	587	1560
15222365	23.1 - 26	159 A8	16 PR	TL	329	Alliance	20	587	1560
15772441	23.1 - 26	145 A6	8 PR	TL	TR 387	BKT	20	592	1560
15772440	23.1 - 26	162 A8	12 PR	TL	TR 387	BKT	20	592	1560
15222391	28 L - 26	173 A8	16 PR	TL	330	Alliance	25	714	1590

¹ = empfohlene Felge / weitere zulässige Felgenbreiten

Alles auf einen Blick:

 statischer Halbmesser in mm	 Abrollumfang in mm	 Tragfähigkeit in kg	 km/h	 Luftdruck in bar
252	1639	475	40/50	2,40
269	1764	580	40/50	2,40
286	1856	487	40/50	2,40
307	1968	670	40/50	2,40
330	1997	670	40/50	2,40
345	2190	900	40/50	2,40
350	2295	1030	40/50	2,40
348	2287	1030	40/50	2,40
363	2384	1120	40/50	2,40
454	2909	800	30	1,00
382	2460	1180	40/50	2,80
387	2530	1180	40/50	2,40
389	2575	1030/950	40/50	1,60
435	2843	1060	40/50	1,60
431	2826	1060	40/50	1,60
446	2926	1150	40/50	1,60
441	2916	1150	40/50	1,60
496	3178	1090	30	1,20
501	3236	1500	40/50	1,60
518	3409	1500	40/50	1,60
505	3236	1500	30	1,20
496	3228	1250/1150	30/40	2,40
495	3302	950	40	1,71
535	3440	1500	40/50	1,60
518	3409	1500	40/50	1,60
540	3546	1650	40/50	1,60
534	3538	1650	40/50	1,60
569	3698	1550	40	1,40
574	3805	1800/1600	30/40	1,80
563	3719	1900	40/50	1,60
557	3728	1900	40/50	1,60
579	3814	2060	40	1,70
635	4150	3000	30	2,30
690	4545	3650	40	1,70
690	4545	4375	40	2,30
690	4688	2900	30	1,10
690	4688	5000	30	1,70
702	4627	6500	40	2,20



Alliance 329



Alliance 330

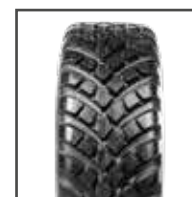

Alliance 579

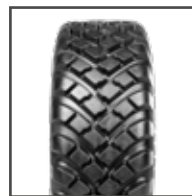

BKT Agrimax Turf RT 333

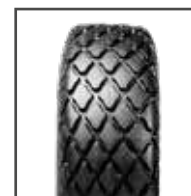

BKT TR 387



BKT TR 391



Bridgestone PD1



Carlisle Turf Pro R-3





Traktor Golf Rasenpflege





Preise und Bestände finden Sie unter www.bohnenkamp.de/shop

Artikel-Nr.	Größe	Last-/Speed-Index	PR	TL/TT	Profil	Marke	Felge ¹	Breite in mm	Außen ø in mm
15226983	320/85 R 28	124 A8/124 B		TL	579	Alliance	10	328	1252
15722336	12.4 - 28	123 A6	8 PR	TL	TR 387	BKT	11/9/10	325	1200
15222450	13.6 - 28	121 A8	6 PR	TL	329	Alliance	12/11	345	1311
15226987	340/85 R 28	127 A8/127 B		TL	579	Alliance	12	343	1289
15226990	360/70 R 28	125 A8/125 B		TL	579	Alliance	11	357	1251
15722437	16.9 - 28	135 A6	8 PR	TL	TR 387	BKT	15/14	440	1400
15226993	480/70 R 28	140 A8/140 B		TL	579	Alliance	15	479	1421
15722465	16.9 - 30	137 A6	8 PR	TL	TR 387	BKT	15/14	440	1450
15722475	18.4 - 30	139 A6	8 PR	TL	TR 387	BKT	16	475	1530
15226996	480/70 R 30	141 A8/141 B		TL	579	Alliance	15	479	1478
15226999	480/70 R 34	143 A8/143 B		TL	579	Alliance	15/14/16	479	1580

¹ = empfohlene Felge / weitere zulässige Felgenbreiten



Alles auf einen Blick:

				
statischer Halbmesser in mm	Abroll- umfang in mm	Tragfähigkeit in kg	km/h	Luftdruck in bar
562	3741	1600	40/50	1,60
550	3576	1550	30	2,30
610	3942	1450	40	1,60
607	3835	1750	40/50	1,60
575	3768	1650	40/50	1,60
630	4074	2180	30	1,70
632	4210	2500	40/50	1,60
655	4220	2300	30	1,70
680	4395	2430	30	1,40
669	4420	2575	40/50	1,60
723	4715	2725	40/50	1,60



Alliance 329



Alliance 579



BKT TR 387



144

Implementreifen

162

Anhängerreifen LKW Diagonal

164

Anhängerreifen LKW Radial



IMPLEMENTREIFEN

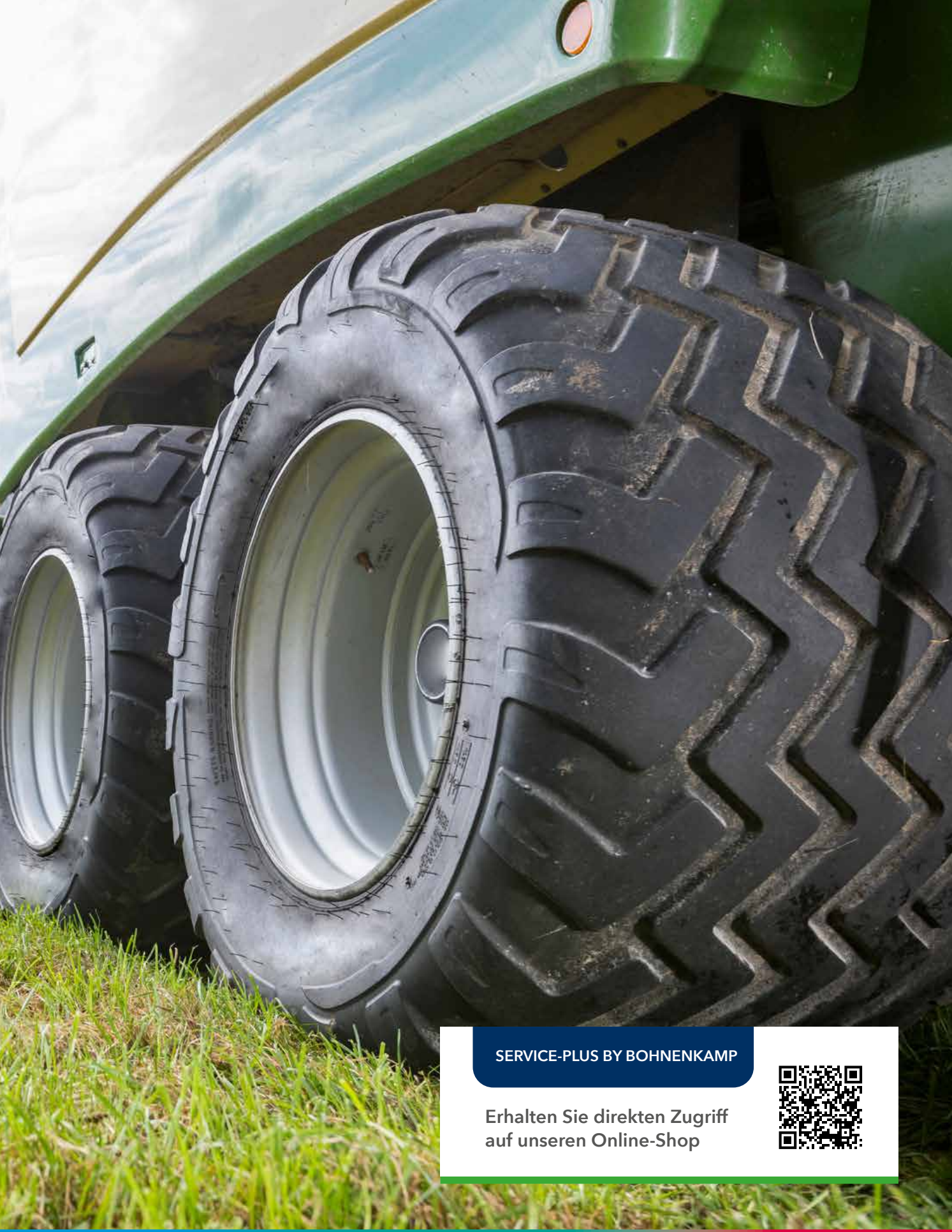

SERVICE-PLUS BY BOHNENKAMP

Erhalten Sie direkten Zugriff
auf unseren Online-Shop





Implementreifen





Preise und Bestände finden Sie unter www.bohnenkamp.de/shop

Artikel-Nr.	Größe	Last-/ Speed-Index	PR	TL/ TT	Profil	Marke	Felge ¹	Breite in mm	Außen ø in mm
19111027	4.00 - 4	60 A6	4 PR	TL	S-310	Deli	2.50	110	320
10714668	4.10/3.50 - 5		4 PR	TT	C156	Cheng Shin	3.25	104	297
15711240	18x8.50 - 8	85 A8	6 PR	TL	Rib 774 (A)	BKT	7.00	225	460
19166140	4.00 - 10	71 M	6 PR	TL	S-252	Deli	3.00	106	458
18692140	4.40 - 10	62 J	4 PR	TT	T690	Trelleborg	3.50	118	476
19111107	7.50 - 10	111 A8	12 PR	TT	SG-316	Deli	6.00/5.50	213	648
19800483	20x8.00 - 10	85 A8/97 A8*		TL	AS Loader	Starco	6.00	218	517
15222035	5 - 12	56 A6	4 PR	TT	FarmPRO 324	Alliance	4	127	550
15711260	5.00 - 12	67 A6/63 A8	6 PR	TT	TR 171	BKT	3.00/3.50/4	130	580
15711280	6.5/80 - 12	80 A8/93 A8*	6 PR	TT	AS 504	BKT	5/4.25	163	608
15711300	7.00 - 12	75 A8/88 A8*	4 PR	TL	AS 504	BKT	4.5	187	683
15711305	7.00 - 12	83 A8/95 A8*	6 PR	TL	AS 504	BKT	4.5/4.25	187	683
15711295	7.00 - 12	95 A8	6 PR	TL	AW 702	BKT	4.25/5	185	665
19111109	7.00 - 12	95 A8	6 PR	TT	SG-316	Deli	5.00	196	684
19800484	23x8.50 - 12	97 A8/109 A8*	8 PR	TL	MP Loader	Starco	7.00	205	580
19811066	250/60 - 12	98 A6/110 A6*		TL	SG Flotation	Starco	8.00/7.00/8.50/9.00	250	602
15711545	10.0/80 - 12	117 A6/110 A8	6 PR	TL	Rib Implement (A)	BKT	9.00/7.0	264	746
15711540	10.0/80 - 12	121 A8	10 PR	TL	AW 702	BKT	9.00/7.0	264	710
19111100	10.0/80 - 12	120 A8	10 PR	TL	SG-316	Deli	7.00	252	708
19800433	23x10.50 - 12	94 A8/107 A8*	8 PR	TL	AS Loader	Starco	8.50/7.00	262	580
18692552	23x10.50 - 12	100 A6	6 PR	TL	T539	Trelleborg	7.00/8.50	247	571
15711285	11.0/65 - 12	101 A8/114 A8*	8 PR	TT	AS 504	BKT	9.00/7.00/8.50	273	700
15710580	300/60 - 12	109 B	8 PR	TL	Trac Master	BKT	10.5/9.5	306	645
15711310	300/65 - 12	116 A8	8 PR	TL	Rib 775	BKT	9.0	305	685
19811067	300/65 - 12	100 A8/122 A8*	8 PR	TL	SG Flotation	Starco	9.00	290	682
15210105	26x12.00 - 12	94 A8/93 B	4 PR	TL	312	Alliance	10.5	289	665
15710507	26x12.00 - 12	112 A6	8 PR	TL	AS 504	BKT	10.50/8.0/8.5/9.0	310	648
15710515	26x12.00 - 12	116 A3/112 A6	8 PR	TL	TR 315	BKT	10.5/8/9	308	655
15710520	26x12.00 - 12	121 A6	12 PR	TL	TR 315	BKT	10.5/8.50/9.50	308	655
18692610	26x12.00 - 12		8 PR	TL	T539	Trelleborg	10.5/9.5	320	652
10000957	320/60 - 12	120 A8/132 A8*		TT	TR 678	BKT	10.50	328	689
18692564	320/60 - 12	132 A8		TT	T421	Trelleborg	10.50	320	690
15211121	9.00 - 13	111 A8/123 A8*	12 PR	TT	223	Alliance	5.50	236	780
15711590	9.00 - 13	116 A8	8 PR	TL	Sand Star	BKT	5.50	245	784

* = höhere Tragfähigkeit für Einsatz auf gezogenen Fahrzeugen, niedrigere Tragfähigkeit für Einsatz auf angetriebenen Fahrzeugen

¹ = empfohlene Felge / weitere zulässige Felgenbreiten

Alles auf einen Blick:

 statischer Halbmesser in mm	 Abrollumfang in mm	 Tragfähigkeit in kg	 km/h	 Luftdruck in bar
135	939	250	30	4,10
		172	16	3,45
217	1390	515	40	3,00
213	1397	345	130	3,50
220	1414	265	100	3,50
289	1970	1090	40	5,00
228	1539	515/730	40	2,90
254	1609	224	30	2,30
272	1750	307/272	30/40	2,80
273	1851	450/650	40	3,60
300	2001	387/560	40	2,40
300	2001	487/690	40	3,40
295	1948	690	40	2,50
306	2050	690	40	3,10
255	1737	730/1030	40	3,40
258	1771	750/1060	30	2,30
329	2186	1285/1060	30/40	3,20
317	2144	1450	40	3,90
310	2122	1400	40	3,90
255	1737	670/975	40	2,50
	1699	800	30	2,20
321	2072	825/1180	40	2,90
285	1885	1030	50	3,20
304	2007	1250	40	2,60
292	2038	1060/1500	40	3,40
292	1929	670/650	40/50	1,40
298	1932	1120	30	3,00
289	1905	1250/1120	15/30	3,00
289	1905	1450	30	4,50
291	1936	1150	30	2,70
327	2111	1400/2000	40	4,00
298	2049	2000	40	4,00
354	2310	1090/1550	40	3,10
342	2297	1250	40	2,75

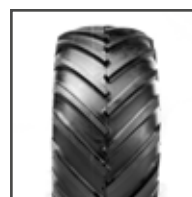

Alliance 312



Alliance 223



Alliance FarmPRO 324



BKT AS 504



BKT AW 702



BKT Rib 774 (A)



BKT Rib 775



BKT Rib Implement (A)



BKT Sand Star



BKT Trac Master



BKT TR 171

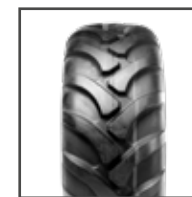

BKT TR 678



Cheng Shin C156



Deli S-310



Deli SG-316



Deli S-252



Starco AS Loader



Starco MP Loader

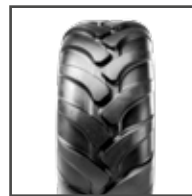

Trelleborg T421



Trelleborg T539



Trelleborg T690



Implementreifen



Preise und Bestände finden Sie unter www.bohnenkamp.de/shop

Artikel-Nr.	Größe	Last-/ Speed-Index	PR	TL/ TT	Profil	Marke	Felge ¹	Breite in mm	Außen ø in mm
19111117	4.50 - 14	43 A6/55 A6*	4 PR	TT	SG-814	Deli	3.00	121	611
15222040	6 - 14	66 A6	4 PR	TT	FarmPRO 324	Alliance	5	155	650
15711630	6 - 14	66 A6/63 A8	4 PR	TT	TR 126	BKT	5	157	655
15222043	7 - 14	72 A6	4 PR	TT	FarmPRO 324	Alliance	5	183	690
15711633	7 - 14	72 A6/68 A8	4 PR	TT	TR 126	BKT	5	170	690
19800161	250/60 - 14	79 A6		TL	M40B	Bridgestone	7	251	660
15711640	9.5L - 14 SL	111 D	8 PR	TT	Farm Implement I-1	BKT	7.00/8	240	735
15711650	200/60 - 14.5	106 A8	10 PR	TT	Rib 774 (B)	BKT	6.75	210	610
15711670	200/60 - 14.5	106 A8	10 PR	TT	SL 441	BKT	6.75	210	610
19111118	200/60 - 14.5	106 A8/102 B	10 PR	TL	SG-319	Deli	6.75	205	616
15711655	250/65 - 14.5	124 A8	14 PR	TL	Rib 774 (B)	BKT	8.00/6.75	255	675
19811065	300/55 - 14.5	120 A8/132 A8*		TL	SG Flotation	Starco	9.50	290	687
15711680	5.00 - 15	75 A8/88 A8*	6 PR	TT	AS 504	BKT	3.50/3.00/4.00	140	657
15211600	6.5/80 - 15	98 A6/94 A8	6 PR	TT	324	Alliance	5.00	163	663
15711686	6.5/80 - 15	92 A8/104 A8*	8 PR	TL	AS 505	BKT	5.0/4.50/5	169	683
15711688	6.70 - 15 SL	97 D	6 PR	TT	Farm Implement I-1	BKT	4.5/5	172	710
15711676	185/65 - 15	76 A8/89 A8*	4 PR	TL	AS 507	BKT	5.5	185	640
15221125	195/65 - 15		8 PR	TL	768	Alliance	5.5	200	665
15711692	7.60 - 15 SL	110 D	10 PR	TT	Farm Implement I-1	BKT	5.50/6	193	734
15711690	7.5L - 15	100 A8/113 A8*	8 PR	TT	AS 504	BKT	6/5/5.50	210	765
12521030	7.5L - 15 SL	93 A8	6 PR	TT	Farm Specialist F-2	Carlisle	6.00/5/6	203	739
19111132	8.0/75 - 15	100 A6	6 PR	TL	SG-811	Deli	7.0/6.0/6.5	209	700
10913010	240/70 - 15	115 A8	8 PR	TL	B 3	Mitas	7/6.5	227	721
15717148	IF 240/80 R 15	129 D		TL	Rib 713	BKT	8	240	765
15711695	9.5L - 15 SL	112 D	8 PR	TT	Farm Implement I-1	BKT	7.00/8	241	765
15711697	9.5L - 15 SL	121 D	12 PR	TL	Farm Implement I-1	BKT	7.00/8	241	765
15711693	10.00 - 15 FI	128 J	8 PR	TL	Farm Highway Tough	BKT	8	274	853
15717150	IF 280/70 R 15	128 D		TL	Rib 713	BKT	8	279	779
15721405	11L - 15 SL	106 A8	8 PR	TL	Pro Rib F2M	BKT	8/10	280	795
15711700	11L - 15 SL	114 A6/110 A8	10 PR	TL	Industrial Rib F3	BKT	8/10	279	813
15711704	11L - 15 SL	113 D	8 PR	TT	Farm Implement I-1	BKT	8/10	270	770
15711698	11L - 15 SL	121 D	12 PR	TL	Farm Implement I-1	BKT	8/10	270	770
15711702	11L - 15 FI	128 J	12 PR	TL	Farm Highway Tough	BKT	8/10	279	777
19111127	320/55 - 15	121 B/133 B*		TL	SG-809 Alptrak	Starco	10	310	730
15717152	IF 320/70 R 15	146 D		TL	Rib 713	BKT	10	320	823
15711706	12.5L - 15 SL	123 D	10 PR	TT	Farm Implement I-1	BKT	10	310	820
15710548	29x12.50 - 15	98 B	6 PR	TL	TR 319	BKT	10	312	755
15710551	29x12.50 - 15	106 B	8 PR	TL	TR 319	BKT	10	312	755
18694025	29x13.50 - 15		4 PR	TT	T411	Trelleborg	10	334	731
12500704	345/60 - 15	107 A4/98 B	4 PR	TL	Multi Trac C/S	Carlisle	10	343	800

* = höhere Tragfähigkeit für Einsatz auf gezogenen Fahrzeugen, niedrigere Tragfähigkeit für Einsatz auf angetriebenen Fahrzeugen

¹ = empfohlene Felge / weitere zulässige Felgenbreiten

Alles auf einen Blick:

 statischer Halbmesser in mm	 Abrollumfang in mm	 Tragfähigkeit in kg	 km/h	 Luftdruck in bar
288	1772	155/218	30	2,50
306	1938	300	30	1,90
305	1978	300/272	30/40	1,90
318	2037	355	30	1,60
320	2070	355/315	30/40	1,60
302	1935	437	30	1,60
326	2154	1090	65	3,00
278	1785	950	40	5,00
278	1785	950	40	5,00
285	1830	950/850	40/50	4,80
303	1978	1600	40	5,50
300	2068	1400/2000	40	4,40
308	1957	387/560	40	3,50
295	1942	750/670	30/40	3,60
325	2106	630/900	40	4,80
319	2080	730	65	3,00
301	1894	400/515	40	2,80
306	1987	650	40	3,20
328	2151	1060	65	4,30
354	2280	800/1150	40	3,70
333	2212	650	40	3,00
314	2072	800	30	2,50
322	2135	1215	40	3,90
354	2324	1850	65	5,00
340	2242	1120	65	3,00
340	2242	1450	65	3,90
409	2612	1800	100	4,10
347	2356	1800	65	3,60
370	2370	950	40	3,00
375		1060	40	3,60
342	2256	1150	65	2,50
342	2256	1450	65	3,60
347	2214	1800	100	6,20
320	2163	1450/2060	50	4,40
367	2590	3000	65	5,20
362	2403	1550	65	3,00
360	2264	750	50	2,10
360	2264	950	50	3,10
325	2171	600	50	1,20
361	2408	975/750	20/50	1,40



Implementreifen







Implementreifen

Preise und Bestände finden Sie unter www.bohnenkamp.de/shop

Artikel-Nr.	Größe	Last-/ Speed-Index	PR	TL/ TT	Profil	Marke	Felge ¹	Breite in mm	Außen ø in mm
15711694	31x13.50 - 15	124 B	12 PR	TL	Flotation Rib Implement	BKT	10	360	780
10711667	31x13.50 - 15		8 PR	TL	C769	Maxxis	10	323	776
12500708	360/55 - 15	116 B	8 PR	TL	Turf Pro R-3	Carlisle	13	361	770
15211645	31x15.50 - 15	109 A8/107 B	6 PR	TL	Grassland Flotation 221	Alliance	13	391	792
15211647	31x15.50 - 15	118 A8/116 B	8 PR	TL	Grassland Flotation 221	Alliance	13	391	792
15211639	31x15.50 - 15	116 B	8 PR	TL	332	Alliance	13	391	792
15710558	31x15.50 - 15	107 B	6 PR	TL	Trac Master	BKT	13	405	810
15710560	31x15.50 - 15	116 B	8 PR	TL	Trac Master	BKT	13	405	810
15710550	31x15.50 - 15	116 B	8 PR	TL	TR 315	BKT	13	390	800
15710552	31x15.50 - 15	116 B	8 PR	TL	TR 313	BKT	13	370	770
15710555	31x15.50 - 15	121 B	10 PR	TL	TR 315	BKT	13	390	800
15717160	31x15.50 R 15	122 B		TL	AS 511	BKT	13	388	785
18694035	33x12.50 - 15		6 PR	TL	T413	Trelleborg	10	320	846
15710565	400/50 - 15	109 A8/121 A8*	8 PR	TL	AS 504	BKT	13	395	790
19111143	400/50 - 15	109 A8/121 A8*	10 PR	TL	SE-374	Deli	13	385	776
19811087	400/50 - 15	109 A8/121 A8*		TL	SE-374 Turf Tech	Starco	13/12	385	776
19111128	400/50 - 15	123 B/135 B*		TL	SG-809 Alptrak	Starco	13	404	781
15211646	33x15.50 - 15	123 B	8 PR	TL	Grassland Flotation 221	Alliance	13	390	875
15710570	33x15.50 - 15	124 B	8 PR	TL	Trac Master	BKT	13	404	865
15710547	27x10 - 15.3	95 A8/107 A8*	8 PR	TL	AS 504	BKT	9.00	260	695
15211615	10.0/75 - 15.3	126 A6/125 A8	10 PR	TL	320 Value Plus	Alliance	9.00	264	760
15211616	10.0/75 - 15.3	136 A6/132 A8	14 PR	TL	320 Value Plus	Alliance	9.00	264	760
15211621	10.0/75 - 15.3	122 A8/135 A8*	18 PR	TL	320	Alliance	9.00	264	760
15711750	10.0/75 - 15.3	111 A8/123 A8*	10 PR	TL	AS 504	BKT	9.00	264	785
15711723	10.0/75 - 15.3	111 A8/123 A8*	10 PR	TL	MP 567	BKT	9.00	258	774
15711730	10.0/75 - 15.3	123 A8	10 PR	TL	AW 702	BKT	9.00	274	760
15711728	10.0/75 - 15.3	123 A8	10 PR	TL	AW 909 V-Line	BKT	9.00	274	760
15711751	10.0/75 - 15.3	118 A8/130 A8*	14 PR	TL	AS 504	BKT	9.00	264	785
15711726	10.0/75 - 15.3	118 A8/130 A8*	14 PR	TL	MP 567	BKT	9.00	258	774
15711734	10.0/75 - 15.3	130 A8	14 PR	TL	AW 702	BKT	9.00	274	760
15711753	10.0/75 - 15.3	123 A8/135 A8*	18 PR	TL	AS 504	BKT	9.00	264	785
15711727	10.0/75 - 15.3	123 A8/135 A8*	18 PR	TL	MP 567	BKT	9.00	258	774
15711738	10.0/75 - 15.3	135 A8	18 PR	TL	AW 702	BKT	9.00	274	760
15711740	10.0/75 - 15.3	137 A8	22 PR	TL	AW 702	BKT	9.00	274	760
19111110	10.0/75 - 15.3	123 A8	10 PR	TL	SG-316	Deli	9.00	280	780
19111111	10.0/75 - 15.3	130 A8	14 PR	TL	SG-316	Deli	9.00	280	780
19871021	255/75 - 15.3	107 A8/119 A8*	8 PR	TL	AS Dumper	Starco	9.00	256	775
15712840	260/75 - 15.3	119 A8/131 A8*		TL	Flotation 647	BKT	9.00	275	785
15717164	260/70 R 15.3	134 A8		TL	AW 712	BKT	9.00	264	760
19172433	260/75 - 15.3	111 A8/123 A8*		TL	SG-816	Deli	9.00	268	778
19811064	260/75 - 15.3	119 A8/131 A8*		TL	SG Flotation	Starco	9.00	270	780

* = höhere Tragfähigkeit für Einsatz auf gezogenen Fahrzeugen, niedrigere Tragfähigkeit für Einsatz auf angetriebenen Fahrzeugen

Alles auf einen Blick:

 statischer Halbmesser in mm	 Abrollumfang in mm	 Tragfähigkeit in kg	 km/h	 Luftdruck in bar
359	2129	1600	50	5,20
	2442	800/1330	80/40	3,10
348	2296	1250	50	3,10
353	2319	1030/975	40/50	2,10
353	2319	1320/1250	40/50	3,10
367	2540	1250	50	3,10
357	2365	975	50	2,10
357	2365	1250	50	3,10
354	2320	1250	50	3,00
342	2233	1250	50	3,10
354	2320	1450	50	4,10
353	2387	1500	50	2,80
	2513	1215	50	1,90
369	2387	1030/1450	40	3,00
351	2300	1030/1450	40	3,00
358	2300	1030/1450	40	3,00
340	2314	1550/2180	50	3,20
375	2530	1550	50	3,10
378	2526	1600	50	3,10
317	2071	690/975	40	3,10
343	2243	1700/1650	30/40	5,30
343	2243	2240/2000	30/40	7,50
343	2243	1500/2180	40	4,70
360	2404	1090/1550	40	3,90
355	2310	1090/1550	40	3,90
343	2227	1550	40	3,90
343	2227	1550	40	5,20
360	2404	1320/1900	40	5,50
355	2310	1320/1900	40	5,50
343	2227	1900	40	5,50
360	2404	1550/2180	40	7,10
355	2310	1550/2180	40	7,10
343	2227	2180	40	7,10
343	2227	2300/2575	40/30	7,10
348	2348	1550	40	3,90
350	2348	1900	40	5,50
352	2235	975/1360	40	3,10
363	2380	1360/1950	40	5,50
344	2304	2120	40	6,00
346	2317	1090/1550	40	3,90
350	2348	1360/1950	40	5,50

¹ = empfohlene Felge / weitere zulässige Felgenbreiten



Implementreifen



Implementreifen





Preise und Bestände finden Sie unter www.bohnenkamp.de/shop

Artikel-Nr.	Größe	Last-/ Speed-Index	PR	TL/ TT	Profil	Marke	Felge ¹	Breite in mm	Außen ø in mm
15211631	11.5/80 - 15.3	145 A6/141 A8	14 PR	TL	320 Value Plus	Alliance	9.00	290	845
15711770	11.5/80 - 15.3	114 A8/126 A8*	8 PR	TL	AS 504	BKT	9.00	290	867
15711759	11.5/80 - 15.3	119 A8/131 A8*	10 PR	TL	MP 567	BKT	9.00	292	868
15711790	11.5/80 - 15.3	131 A8	10 PR	TL	AW 702	BKT	9.00	297	844
15711788	11.5/80 - 15.3	131 A8	10 PR	TL	AW 909 V-Line	BKT	9.00	297	844
15711780	11.5/80 - 15.3	123 A8/135 A8*	12 PR	TL	AS 504	BKT	9.00	290	867
15711789	11.5/80 - 15.3	126 A8/139 A8*	14 PR	TT	AS 504	BKT	9.00	290	867
15711784	11.5/80 - 15.3	126 A8/139 A8*	14 PR	TL	AS 504	BKT	9.00	290	867
15711761	11.5/80 - 15.3	126 A8/139 A8*	14 PR	TL	MP 567	BKT	9.00	292	868
15711795	11.5/80 - 15.3	139 A8	14 PR	TL	AW 702	BKT	9.00	297	844
15711797	11.5/80 - 15.3	143 A8	18 PR	TL	AW 702	BKT	9.00	297	844
15711764	11.5/80 - 15.3	130 A8/143 A8*	18 PR	TL	MP 567	BKT	9.00	292	868
19111125	11.5/80 - 15.3	131 A8	10 PR	TL	SG-316	Deli	9.00	290	864
19111124	11.5/80 - 15.3	139 A8	14 PR	TL	Forestry 316	Deli	9.00	292	870
19111126	11.5/80 - 15.3	139 A8	14 PR	TL	SG-316	Deli	9.00	292	870
19811071	295/80 - 15.3	119 A8/131 A8*	10 PR	TL	AS Dumper	Starco	9.00	286	856
19811063	300/80 - 15.3	126 A8/138 A8*		TL	SG Flotation	Starco	9.00	290	862
15211633	12.5/80 - 15.3	148 A6/144 A8	14 PR	TL	320 Value Plus	Alliance	9.00	307	875
15711800	12.5/80 - 15.3	142 A8	14 PR	TL	AW 702	BKT	9.00/11.00	312	885
15711802	12.5/80 - 15.3	142 A8	14 PR	TL	AW 909 V-Line	BKT	9.00	312	885
19111120	12.5/80 - 15.3	142 A8	14 PR	TL	SG-316	Deli	9.00	310	889
15711805	280/60 - 15.5	102 A8/115 A8*	8 PR	TL	TR 678	BKT	8.0/8.25	275	750
15711806	280/60 - 15.5	116 A8/128 A8*	14 PR	TL	TR 678	BKT	8.0/8.25	275	750
18693660	280/60 - 15.5	115 A8		TL	T421	Trelleborg	8.00	260	730
15211654	400/60 - 15.5	132 A8/145 A8*	14 PR	TL	Flotation 328	Alliance	13.00	404	874
15211653	400/60 - 15.5	132 A8/145 A8*	14 PR	TL	FarmPRO 327	Alliance	13.00	405	874
15211664	400/60 - 15.5	152 A6/148 A8	16 PR	TL	320 Value Plus	Alliance	13.00	404	874
15711810	400/60 - 15.5	133 A8/145 A8*	14 PR	TL	TR 882	BKT	13.00	400	875
15711811	400/60 - 15.5	133 A8/145 A8*	14 PR	TL	TR 882	BKT	13.00	400	875
15711812	400/60 - 15.5	137 A8/149 A8*	18 PR	TL	TR 882	BKT	13.00	400	875
15711820	400/60 - 15.5	145 A8	14 PR	TL	AW 708	BKT	13.00	405	875
15711822	400/60 - 15.5	149 A8	18 PR	TL	AW 708	BKT	13.00	405	875
19172430	400/60 - 15.5	132 A8/145 A8*	14 PR	TL	SG-802	Deli	13.00	400	872
19111129	400/60 - 15.5	145 A8	14 PR	TL	Forestry 316	Deli	13.00	396	870
19111130	400/60 - 15.5	145 A8	14 PR	TL	SG-316	Deli	13.00	396	870
19172432	400/60 - 15.5	152 A8	18 PR	TL	SG-316	Deli	13.00	396	870
19172431	400/60 - 15.5	140 A8/152 A8*	18 PR	TL	SG-802	Deli	13.00	400	874
15211655	500/55 - 15.5	145 A8/141 B	12 PR	TL	320	Alliance	16	503	944

* = höhere Tragfähigkeit für Einsatz auf gezogenen Fahrzeugen, niedrigere Tragfähigkeit für Einsatz auf angetriebenen Achsen

¹ = **empfohlene Felge** / weitere zulässige Felgenbreiten

Alles auf einen Blick:

 statischer Halbmesser in mm	 Abrollumfang in mm	 Tragfähigkeit in kg	 km/h	 Luftdruck in bar
372	2456	2900/2575	30/40	6,50
380	2540	1180/1700	40	2,70
393	2578	1360/1950	40	3,40
370	2473	1950	40	3,40
370	2473	1950	40	3,40
380	2540	1550/2180	40	4,10
380	2540	1700/2430	40	4,80
380	2540	1700/2430	40	4,80
393	2578	1700/2430	40	4,75
370	2473	2430	40	4,75
370	2473	2725	40	6,10
393	2578	1900/2725	40	6,00
383	2601	1950	40	3,40
382	2619	2430	40	4,75
382	2619	2430	40	4,75
388	2485	1360/1950	40	3,40
368	2595	1800/2360	40	3,60
389	2558	3150/2800	30/40	5,90
387	2593	2650	40	4,30
387	2593	2650	40	4,30
384	2676	2650	40	4,30
357	2250	850/1215	40	2,90
357	2250	1250/1800	40	2,40
325	2142	1215	40	2,40
377	2510	2000/2900	40	3,60
375	2498	2000/2900	40	3,60
377	2569	3550/3150	30/40	5,50
378	2605	2060/2900	40	3,60
378	2605	2060/2900	40	3,60
378	2605	2300/3250	40	4,50
380	2564	2900	40	4,90
380	2564	3250	40	4,50
374	2584	2000/2900	40	3,60
370	2578	2900	40	3,60
370	2578	2900	40	3,60
374	2578	3550	40	5,00
374	2590	2500/3550	40	5,00
410	2720	2900/2575	40/50	2,40



Alliance 320 / 320 Value Plus



Alliance FarmPRO 327



Alliance Flotation 328

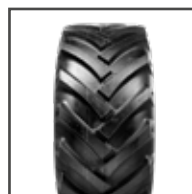

BKT AS 504



BKT AW 702



BKT AW 708



BKT AW 909 V-Line



BKT MP 567

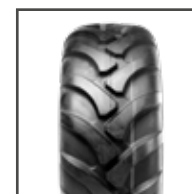

BKT TR 678



BKT TR 882



Deli SG-316



Deli Forestry 316



Deli SG-802

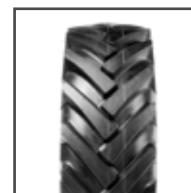

Starco AS Dumper



Starco SG Flotation



Trelleborg T421



Implementreifen





Preise und Bestände finden Sie unter www.bohnenkamp.de/shop

Artikel-Nr.	Größe	Last-/ Speed-Index	PR	TL/ TT	Profil	Marke	Felge ¹	Breite in mm	Außen ø in mm
15711722	4.00 - 16	66 A8/78 A8*	4 PR	TT	AS 504	BKT	3.00/2.50	110	628
19111131	5.00 - 16	76 A8	6 PR	TT	SG-811	Deli	4.0	144	701
15711823	6.00 - 16	83 A8/95 A8*	6 PR	TT	AS 504	BKT	4.00/4.50	164	735
15711825	6.00 - 16	95 A8	6 PR	TT	AW 702	BKT	4.00/4.50	169	722
15222049	6.50 - 16	98 A6	8 PR	TT	FarmPRO 324	Alliance	4.50	175	760
15222053	7 - 16	75 A6	4 PR	TT	FarmPRO 324	Alliance	6.00	183	742
15711708	7 - 16	75 A6/71 A8	4 PR	TT	TR 144	BKT	6/6.00	183	740
19011340	190/90 - 16	108 A8	8 PR	TL	AF302	Trelleborg	4.50	192	746
19011370	200/90 - 16	111 A8	8 PR	TL	AF302	Trelleborg	5.00	204	764
19966335	7.50 - 16	122 D	14 PR	TT	BTG208	Boka Agrar Trans	6.0/5.50/6.00/6.50	202	785
15711826	7.50 - 16 SL	110 D	8 PR	TT	Farm Implement I-1	BKT	5.50/6.00	205	785
15711712	7.50 - 16	111 J	8 PR	TT	Sand King	BKT	5.50/6.00	215	820
19011410	210/95 - 16	120 A8	10 PR	TL	AF302	Trelleborg	5.50	218	802
10691455	8 - 16	82 A6	4 PR	TT	FD	Bridgestone	6.00	208	790
10691450	8 - 16	82 A6	4 PR	TT	FSLM	Bridgestone	6.00	197	789
19966330	8.25 - 16	126 D	14 PR	TT	BTG208	Boka Agrar Trans	6.5/6.00	229	832
15711711	9.00 - 16 SL	122 D	10 PR	TT	Farm Implement I-1	BKT	6/8	234	845
15711818	9.0/70 - 16	106 A8/119 A8*	10 PR	TL	AS 504	BKT	7	222	760
15711827	250/80 - 16	113 A8/125 A8*	8 PR	TT	Farm 2000	BKT	8/7/9	240	820
15711830	10.5/65 - 16	123 A8	10 PR	TL	AW 702	BKT	9	270	760
15711832	10.5/65 - 16	130 A8	14 PR	TL	AW 702	BKT	9	270	760
19111133	10.5/65 - 16	130 A8	14 PR	TT	SG-316	Deli	8.0	254	760
13315006	270/65 R 16	134 A8		TL	XP 27	Michelin	8/7/9	265	755
15711710	11L - 16 SL	112 A8	10 PR	TL	Industrial Rib F3	BKT	8/10	279	830
15711713	11L - 16 SL	119 D	10 PR	TT	Farm Implement I-1	BKT	8/10	270	795
15211668	12.4 - 16	121 A8	10 PR	TT	316	Alliance	11/10	315	931
15711833	12.5/70 - 16	125 A2	8 PR	TL	AT 621	BKT	10	315	855
15711715	12.5L - 16 SL	128 D	12 PR	TT	Farm Implement I-1	BKT	10	310	845
15711838	13.0/55 - 16	133 A8	14 PR	TL	AW 702	BKT	11.0	336	770
15711839	13.0/55 - 16	138 A8	18 PR	TL	AW 702	BKT	11.0	336	770
15711836	13.0/75 - 16	135 A8	10 PR	TL	AW 702	BKT	11.0	340	890
15211667	340/55 - 16	121 A8/133 A8*	12 PR	TL	FarmPRO 327	Alliance	11	340	780
15711817	340/55 - 16	121 A8/133 A8*		TL	AW 729	BKT	11.0	343	785
19111135	355/65 - 16	142 A8	14 PR	TL	SG-316	Deli	11.00	353	874
15211666	360/65 - 16	138 A8/150 A8*		TL	FarmPRO 327	Alliance	11	357	874
15711834	14.0/65 - 16	142 A8	14 PR	TL	AW 705	BKT	11.0	353	870
15711716	14L - 16.1 SL	127 A8	12 PR	TL	Pro Rib F2M	BKT	11	355	980
15711719	14L - 16.1 SL	134 D	12 PR	TL	Farm Implement I-1	BKT	11	360	935
15211672	16.5 L - 16.1 SL	138 A8/134 B	10 PR	TL	222	Alliance	14	419	1024
15711717	16.5L - 16.1 SL	138 B	10 PR	TL	Farm Implement I-1	BKT	14	435	1025

* = höhere Tragfähigkeit für Einsatz auf gezogenen Fahrzeugen, niedrigere Tragfähigkeit für Einsatz auf angetriebenen Achsen

¹ = **empfohlene Felge** / weitere zulässige Felgenbreiten

Alles auf einen Blick:

 statischer Halbmesser in mm	 Abrollumfang in mm	 Tragfähigkeit in kg	 km/h	 Luftdruck in bar
296	1935	300/425	40	2,80
329	2081	400	40	3,70
343	2190	487/690	40	2,80
337	2150	690	40	2,75
354	2304	750	30	4,20
344	2204	387	30	1,60
344	2223	387/345	30/40	1,60
331	2223	1000	40	2,40
338	2227	1090	40	2,40
383	2464	1500	65	7,30
350	2300	1060	65	3,30
378	2471	1090	100	4,11
347	2392	1400	40	2,80
364	2332	475	30	1,60
362	2320	475	30	1,60
407	2612	1700	65	6,30
374	2476	1500	65	3,60
355	2285	950/1360	40	4,40
369	2429	1150/1650	40	2,50
343	2112	1550	40	3,80
343	2112	1900	40	5,30
340	2296	1900	40	5,30
333	2300	2120	40	5,00
385		1120	40	3,60
355	2329	1360	65	3,00
429	2783	1450	40	3,50
385	2584	1650	10	2,60
374	2476	1800	65	3,60
345	2256	2060	40	4,20
345	2256	2360	40	5,40
396	2726	2180	40	3,00
365	2354	1450/2060	40	3,40
358	2358	1450/2060	40	3,20
386	2631	2650	40	4,00
388	2590	2360/3350	40	4,60
388	2549	2650	40	4,00
453	2920	1750	40	3,60
409	2740	2120	65	3,00
438	2922	2360/2120	40/50	2,50
444	3003	2360	65	2,50



Implementreifen



Implementreifen





Preise und Bestände finden Sie unter www.bohnenkamp.de/shop

Artikel-Nr.	Größe	Last-/ Speed-Index	PR	TL/ TT	Profil	Marke	Felge ¹	Breite in mm	Außen ø in mm
15211636	21.5 L - 16.1 SL		10 PR	TL	542	Alliance	18	545	1139
15711718	21.5 L - 16.1 SL	152 B	14 PR	TL	Farm Implement I-1	BKT	18/16	550	1130
15717188	305/70 R 16.5	148 A8/148 B		TL	AW 711	BKT	9.75	325	851
15717190	340/60 R 16.5	145 A8/145 B		TL	AW 711	BKT	11/12	324	820
15711841	380/55 R 16.5	150 A8/150 B		TL	AW 711	BKT	12/11.75	360	830
15717192	395/55 R 16.5	152 A8/152 B		TL	AW 711	BKT	12	394	838
15211683	380/55 - 17	125 A8/138 A8*	12 PR	TL	FarmPRO 327	Alliance	13	391	850
19111138	380/55 - 17	141 A8/137 B	12 PR	TL	SG-316	Deli	13.00	384	845
19800356	380/55 - 17	125 A8/138 A8*	12 PR	TL	SG Flotation	Starco	13.00	377	872
19811072	380/55 - 17	125 A8/138 A8*	12 PR	TL	AS Dumper II	Starco	13.00	377	872
15211691	15.0/55 - 17	138 A6	10 PR	TL	320 Value Plus	Alliance	13.00	391	850
15211687	15.0/55 - 17	141 A6/138 A8	14 PR	TL	320 Value Plus	Alliance	13.00	391	850
15711853	15.0/55 - 17	122 A8/134 A8*	10 PR	TL	AW 729	BKT	13.00/13	385	850
15711860	15.0/55 - 17	122 A8/134 A8*	10 PR	TL	AS 504	BKT	13.00/13	380	890
15711865	15.0/55 - 17	128 A8/141 A8*	14 PR	TL	AS 504	BKT	13.00/13	380	890
15711842	15.0/55 - 17	134 A8	10 PR	TL	AW 909 V-Line	BKT	13.00/13	391	850
15711840	15.0/55 - 17	134 A8	10 PR	TL	AW 705	BKT	13.00/13	381	850
15711850	15.0/55 - 17	134 A8	10 PR	TL	Rib 774 (A)	BKT	13.00/13	391	850
15711847	15.0/55 - 17	141 A8	14 PR	TL	AW 705	BKT	13.00	381	850
15711848	15.0/55 - 17	146 A8	18 PR	TL	AW 705	BKT	13.00	381	850
19172455	400/55 R 17	152 D		TL	GU-783 HS Flotation	Starco	13.0	410	882
15711866	420/55 - 17	121 A8/133 A8*		TL	AW 726	BKT	13.00	415	890
15711867	420/55 - 17	133 A8/145 A8*	16 PR	TL	AS 504	BKT	13.00	430	910
15215075	425/55 R 17	140 A8/137 D		TL	Lawn Master 221	Alliance	13	420	890
15717220	440/50 R 17	135 D		TL	Trac Super	BKT	14.00/13.00	441	872
10915100	440/50 R 17	135 D		TL	AR-04	Mitas	14/13	441	873
15211678	450/55 - 17	132 A8/129 B	8 PR	TL	Grassland Flotation 221	Alliance	16	440	925
15211674	19.0/45 - 17	143 A8/139 B	14 PR	TL	222	Alliance	16	480	850
15211688	19.0/45 - 17	148 A6/144 A8	14 PR	TL	320 Value Plus	Alliance	16.00	472	866
15712420	19.0/45 - 17	131 A8/144 A8*	14 PR	TL	AS 504	BKT	16.00	465	865
15712419	19.0/45 - 17	134 A8/147 A8*	16 PR	TL	AS 504	BKT	16.00	465	865
15712410	19.0/45 - 17	138 A8	10 PR	TL	AW 708	BKT	16.00	491	866
15712415	19.0/45 - 17	144 A8	14 PR	TL	AW 708	BKT	16.00	491	866
15712417	19.0/45 - 17	148 A8	18 PR	TL	AW 708	BKT	16.00	491	866
15712421	19.0/45 - 17	152 A8	22 PR	TL	AW 708	BKT	16.00	491	866
15211676	480/45 - 17	134 A8/146 A8*	14 PR	TL	FarmPRO 327	Alliance	16.00	480	865
15211682	480/45 - 17	136 A8/149 A8*	18 PR	TL	FarmPRO 327	Alliance	16.00	480	865
15717225	VF 480/45 R 17	167 A8/167 B		TL	AW 711	BKT	16.00	491	866

* = höhere Tragfähigkeit für Einsatz auf gezogenen Fahrzeugen, niedrigere Tragfähigkeit für Einsatz auf angetriebenen Achsen

¹ = **empfohlene Felge** / weitere zulässige Felgenbreiten

Alles auf einen Blick:

 statischer Halbmesser in mm	 Abrollumfang in mm	 Tragfähigkeit in kg	 km/h	 Luftdruck in bar
494	3226	2994	48	1,90
485	3413	3550	50	2,50
371	2552	3150	40/50	5,00
368	2476	2900	40/50	5,00
372	2500	3350	40/50	5,00
365	2516	3550	40/50	5,00
384	2516	1650/2360	40	2,80
384	2522	2575/2300	40/50	3,30
374	2563	1650/2360	40	2,80
380	2581	1650/2360	40	2,80
372	2490	2360/2120	30/40	2,60
372	2490	2575/2360	30/40	3,70
377	2560	1500/2120	40	2,60
395	2608	1500/2120	40	2,60
395	2608	1800/2575	40	3,70
377	2490	2120	40	2,60
391	2575	2120	40	3,60
377	2490	2120	40	2,60
391	2575	2575	40	4,90
391	2575	3000	40	4,70
380	2714	3550	65	5,00
392	2584	1450/2060	40	2,00
407	2712	2060/2900	40	3,50
399	2656	2500/2300	40/65	3,50
395	2674	2180	65	3,60
393	2605	2180	65	3,60
413	2711	2000/1850	40/50	2,50
375	2470	2725/2430	40/50	4,00
384	2578	3150/2800	30/40	2,80
389	2578	1950/2800	40	2,80
389	2578	2120/3075	40	3,10
380	2536	2360	40	3,00
380	2536	2800	40	3,90
380	2536	3150	40	3,30
380	2536	3550	40	3,90
400	2592	2120/3000	40	2,80
400	2592	2240/3250	40	3,30
363	2644	5450	40/50	5,00



Implementreifen



Implementreifen





Preise und Bestände finden Sie unter www.bohnenkamp.de/shop

Artikel-Nr.	Größe	Last-/ Speed-Index	PR	TL/ TT	Profil	Marke	Felge ¹	Breite in mm	Außen ø in mm
19811062	480/45 - 17	134 A8/146 A8*	14 PR	TL	SG Flotation	Starco	16.00	451	889
15211677	500/50 - 17	136 A8/149 A8*	14 PR	TL	FarmPRO 327	Alliance	16	500	960
15211695	500/50 - 17	141 A8/154 A8*	18 PR	TL	FarmPRO 327	Alliance	16	500	960
15211689	500/50 - 17	153 A6/149 A8	14 PR	TL	320 Value Plus	Alliance	16	500	932
15216051	500/50 R 17	149 D		TL	Flotmaster 381	Alliance	16.00	494	950
15712428	500/50 - 17	137 A8/149 A8*	14 PR	TL	Flotation 648	BKT	16.00	510	945
15712431	500/50 - 17	140 A8	10 PR	TL	AW 708	BKT	16.00	500	945
15712436	500/50 - 17	149 A8	14 PR	TL	AW 708	BKT	16.00	500	945
15712438	500/50 - 17	154 A8	18 PR	TL	AW 708	BKT	16.00	500	945
15712429	500/50 - 17	145 A8/157 A8*	18 PR	TL	Flotation 648	BKT	16.00	510	945
10915105	500/50 R 17	149 D		TL	AR-03	Mitas	16	502	933
15712439	500/65 - 17	160 A8	18 PR	TL	AW 708	BKT	16.0	520	1070
15712437	520/50 - 17	162 A8		TL	AW 708	BKT	16.00	516	952
15712845	520/50 - 17	147 B/159 B*		TL	Flotation 647	BKT	16.00	516	965
19800485	520/50 - 17	162 A8/159 B		TL	AW	Starco	16.00	520	970
19811061	520/50 - 17	147 B/159 B*		TL	SG Flotation	Starco	16.00	510	950
15712440	215/75 - 17.5	142 A8	16 PR	TL	Rib Master	BKT	6.75	220	775
15711689	400/45 L 17.5	156 A8	14 PR	TL	Terra Trax	BKT	14.00	398	785
19172460	400/45 L 17.5	156 B		TL	SG-815	Deli	14.00/13.00	392	770
19911655	400/45 - 17.5	156 A8	14 PR	TL	Magic D-905	Magic	14.00	397	798
15222054	8 - 18	94 A6	6 PR	TT	FarmPRO 324	Alliance	7	206	835
15712392	250/80 - 18	115 A8/127 A8*	8 PR	TT	Farm 2000	BKT	8/7/9	240	870
13315011	270/65 R 18	124 A8/136 A8*		TL	XP 27	Michelin	8/9	265	810
15212311	10.5/80 - 18	135 A6/131 A8	10 PR	TL	320 Value Plus	Alliance	9	274	885
15711870	10.5/80 - 18	119 A8/131 A8*	10 PR	TL	AS 504	BKT	9/8	274	907
15772510	10.5/80 - 18	119 A8/131 A8*	10 PR	TL	AT 603	BKT	9/8	274	907
15711875	10.5/80 - 18	131 A8	10 PR	TL	AW 702	BKT	9	275	885
15711877	10.5/80 - 18	138 A8	14 PR	TL	AW 702	BKT	9	275	885
15212315	12.0/75 - 18	139 A6/135 A8	12 PR	TT	317 (Spacer)	Alliance	9	299	915
15212332	12.5/80 - 18	145 A6/142 A8	12 PR	TL	320 Value Plus	Alliance	9/11	308	965
15212337	12.5/80 - 18	152 A6/148 A8	16 PR	TL	320 Value Plus	Alliance	9	308	965
15711930	12.5/80 - 18	129 A8/142 A8*	12 PR	TL	AS 504	BKT	9/11	308	987
15772520	12.5/80 - 18	129 A8/142 A8*	12 PR	TL	AT 603	BKT	9/11	308	987
15711935	12.5/80 - 18	135 A8/148 A8*	16 PR	TL	AS 504	BKT	9/11	308	987
15711938	12.5/80 - 18	138 A8/150 A8*	18 PR	TL	AS 504	BKT	9/11	308	987

* = höhere Tragfähigkeit für Einsatz auf gezogenen Fahrzeugen, niedrigere Tragfähigkeit für Einsatz auf angetriebenen Achsen

¹ = empfohlene Felge / weitere zulässige Felgenbreiten

Alles auf einen Blick:

 statischer Halbmesser in mm	 Abrollumfang in mm	 Tragfähigkeit in kg	 km/h	 Luftdruck in bar
412	2633	2120/3000	40	3,20
435	2840	2240/3250	40	2,75
435	2840	2575/3750	40	3,50
424	2760	3650/3250	30/40	2,80
421	2870	3250	65	4,50
416	2750	2300/3250	40	2,80
416	2750	2500	40	2,00
416	2750	3250	40	2,80
416	2750	3750	40	3,60
416	2750	2900/4125	40	4,00
425	2800	3250	65	5,00
462	3135	4500	40	3,50
404	2777	4750	40	4,00
426	2907	3075/4375	50	4,00
425	2900	4750/4375	40/50	4,00
419	2903	3075/4375	50	4,00
360	2310	2650	40	9,00
361	2370	4000	40	6,00
348	2285	4000	50	6,00
372	2347	4000	40	6,00
380	2496	670	30	1,90
394	2679	1215/1750	40	2,80
361	2472	1600/2240	40	5,00
390	2620	2180/1950	30/40	3,70
405	2657	1360/1950	40	3,70
422	2727	1360/1950	40	3,70
395	2593	1950	40	3,70
395	2593	2360	40	5,10
411	2690	2430/2180	30/40	4,00
407	2803	2900/2650	30/40	3,70
422	2870	3550/3150	30/40	4,90
438	2892	1850/2650	40	3,70
448	3027	1850/2650	40	3,70
438	2892	2180/3150	40	4,90
438	2892	2360/3350	40	5,50



Alliance 317 (Spacer)

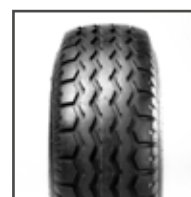

Alliance 320 Value Plus

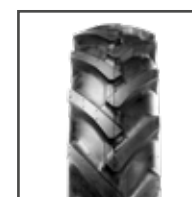

Alliance FarmPRO 324



Alliance FarmPRO 327

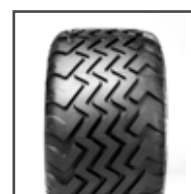

Alliance Flotmaster 381



BKT AS 504



BKT AT 603

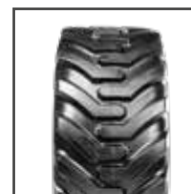

BKT AT 621



BKT AW 702



BKT AW 708

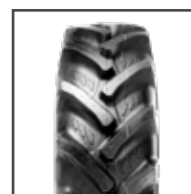

BKT Farm 2000



BKT Flotation 647



BKT Flotation 648



BKT Rib Master



BKT Terra Trax



Deli SG-815



Magic Magic D-905

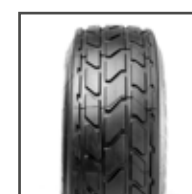

Michelin XP 27

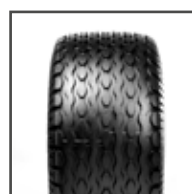

Mitas AR-03



Starco AW



Starco SG Flotation



Implementreifen





Preise und Bestände finden Sie unter www.bohnenkamp.de/shop

Artikel-Nr.	Größe	Last-/Speed-Index	PR	TL/TT	Profil	Marke	Felge ¹	Breite in mm	Außen ø in mm
15711880	12.5/80 - 18	142 A8	12 PR	TL	AW 702	BKT	9/11	308	965
15711886	12.5/80 - 18	148 A8	16 PR	TL	AW 702	BKT	9/11	308	965
19111140	315/80 - 18	143 A8	12 PR	TL	SG-316	Deli	10.0/9.0/11.0	308	961
19811073	315/80 - 18	136 A8/148 A8*	16 PR	TL	AS Dumper	Starco	9.00/9/11	314	981
15212317	320/80 - 18	129 A8/142 A8*	12 PR	TL	FarmPRO 327	Alliance	10	320	970
15217021	340/65 R 18	145 E		TL	571	Alliance	11	340	892
15717280	IF 340/65 R 18	153 A8/153 B		TL	AW 711	BKT	11	330	899
13315110	340/65 R 18	137 A8/149 A8*		TL	XP 27	Michelin	11/9	343	891
15712360	340/70 - 18	150 A8	16 PR	TL	Rib 774 (B)	BKT	11.0	342	902
10915150	355/60 R 18	142 J		TL	AR-05	Mitas	11	352	890
15212359	13.0/65 - 18	144 A8/140 B	16 PR	TT	320	Alliance	11	336	890
15712355	13.0/65 - 18	144 A8	16 PR	TL	AW 702	BKT	11.0	336	890
15712350	13.0/65 - 18	144 A8	16 PR	TL	AW 702 V-Line	BKT	11.0	336	890
15712365	14.5/80 - 18	155 A8	12 PR	TT	AW 702	BKT	11.0/12/13	362	1047
15212400	15.0/70 - 18	145 A8/141 B	12 PR	TL	320	Alliance	13	391	990
15212405	15.0/70 - 18	151 A8/147 B	16 PR	TL	320	Alliance	13	391	990
15712380	15.0/70 - 18	145 A8	12 PR	TL	AW 705	BKT	13.00/13	405	1010
15712382	15.0/70 - 18	151 A8	16 PR	TL	AW 705	BKT	13.00/13	405	1010
15772531	15.5/60 - 18	141 A2	12 PR	TL	AT 621	BKT	13	394	940
15717290	400/60 R 18	159 A8/159 B		TL	AW 711	BKT	14/13	394	945
15717292	440/55 R 18	159 A8/159 B		TL	AW 711	BKT	14/13	410	945
10001402	425/70 - 18	143 B/155 B*		TL	Flotation 647	BKT	13.00	435	1065
19811074	425/50 - 18	150 A8/134 A8*		TL	AS Dumper II	Starco	14.00	410	882
19811113	425/50 - 18	134 G		TL	SG-809 Alptrak	Starco	14.00	400	886
19811068	425/70 - 18	143 B/155 B*		TL	SG Flotation	Starco	13.00	480	1092
15712445	6.50 - 20	112 A6	10 PR	TT	BK 308	BKT	5.50/4.00/5.00	190	865
19966340	7.00 - 20	127 D	14 PR	TT	BTG208	Boka Agrar Trans	5.5/5.50/6.0	203	898
19966345	7.50 - 20	130 D	14 PR	TT	BTG208	Boka Agrar Trans	6.0/6.00/6.50	219	926
19966350	8.25 - 20	136 D	14 PR	TT	BTG208	Boka Agrar Trans	6.5/7.0/7.00	242	974
19966355	9.00 - 20	141 D	14 PR	TT	BTG208	Boka Agrar Trans	7.0/7.00/7.5/7.50	259	1038
19966360	10.00 - 20	146 D	16 PR	TT	BTG208	Boka Agrar Trans	7.5/7.50/8.0/8.00	274	1030
19966365	11.00 - 20	149 D	16 PR	TT	BTG208	Boka Agrar Trans	8.0/8.00/8.5	301	1058
19966370	12.00 - 20	154 D	18 PR	TT	BTG208	Boka Agrar Trans	8.5	320	1126
15212488	400/70 - 20	139 A8/151 A8*	12 PR	TL	FarmPRO 327	Alliance	13	408	1075
15712486	400/70 - 20	149 A8	12 PR	TL	AS 504	BKT	13/12/14	408	1097
12500802	400/70 - 20	129 A8	6 PR	TL	Xtra Grip	Carlisle	14.00	424	1095
15212480	16.0/70 - 20	151 A8/147 B	12 PR	TT	320	Alliance	13.00/12	418	1075
15212485	16.0/70 - 20	154 A8/150 B	14 PR	TT	320	Alliance	13.00/12	418	1075
15712480	16.0/70 - 20	135 A8/147 A8*	10 PR	TL	AS 504	BKT	13/12/14	408	1097
15712481	16.0/70 - 20	142 A8/154 A8*	14 PR	TL	AS 504	BKT	13/12/14	408	1097

* = höhere Tragfähigkeit für Einsatz auf gezogenen Fahrzeugen, niedrigere Tragfähigkeit für Einsatz auf angetriebenen Achsen

¹ = empfohlene Felge / weitere zulässige Felgenbreiten

Alles auf einen Blick:

 statischer Halbmesser in mm	 Abrollumfang in mm	 Tragfähigkeit in kg	 km/h	 Luftdruck in bar
432	2827	2650	40	5,00
432	2827	3150	40	4,90
417	2825	2725	40	3,20
444	2839	2240/3150	40	4,90
434	2860	1850/2650	40	3,70
405	2717	2900	70	5,00
381	2662	3650	40/50	4,00
393	2720	2300/3250	40	5,00
414	2688	3350	40	5,20
398	2650	2650	100	5,00
398	2611	2800/2500	40/50	4,90
398	2608	2800	40	4,90
398	2608	2800	40	6,70
446	3068	3875	40	4,50
442	2902	2900/2575	40/50	3,10
442	2902	3450/3075	40/50	4,21/4,25
447	3092	2900	40	3,10
447	3092	3450	40	4,21
428	2871	2575	10	3,00
419	2807	4375	40/50	5,50
432	2893	4375	40/50	5,00
		2725	50	3,50
410	2575	2120/3350	40	3,50
394	2691	2120	90	3,50
461	3209	2725/3875	50	3,50
393	2534	1120	30	4,80
130	2820	1750	65	8,40
445	2904	1900	65	8,10
464	3058	2240	65	8,10
464	3260	2575	65	7,70
502	3234	3000	65	8,10
517	3322	3250	65	8,10
536	3536	3750	65	8,10
476	3112	2430/3450	40	3,00
487	3214	3250	40	4,00
490	3277	1850	40	2,10
465	3140	3450/3075	40/50	3,00
470	3164	3750/3350	40/50	3,50
487	3214	2180/3075	40	2,50
487	3214	2650/3750	40	3,50

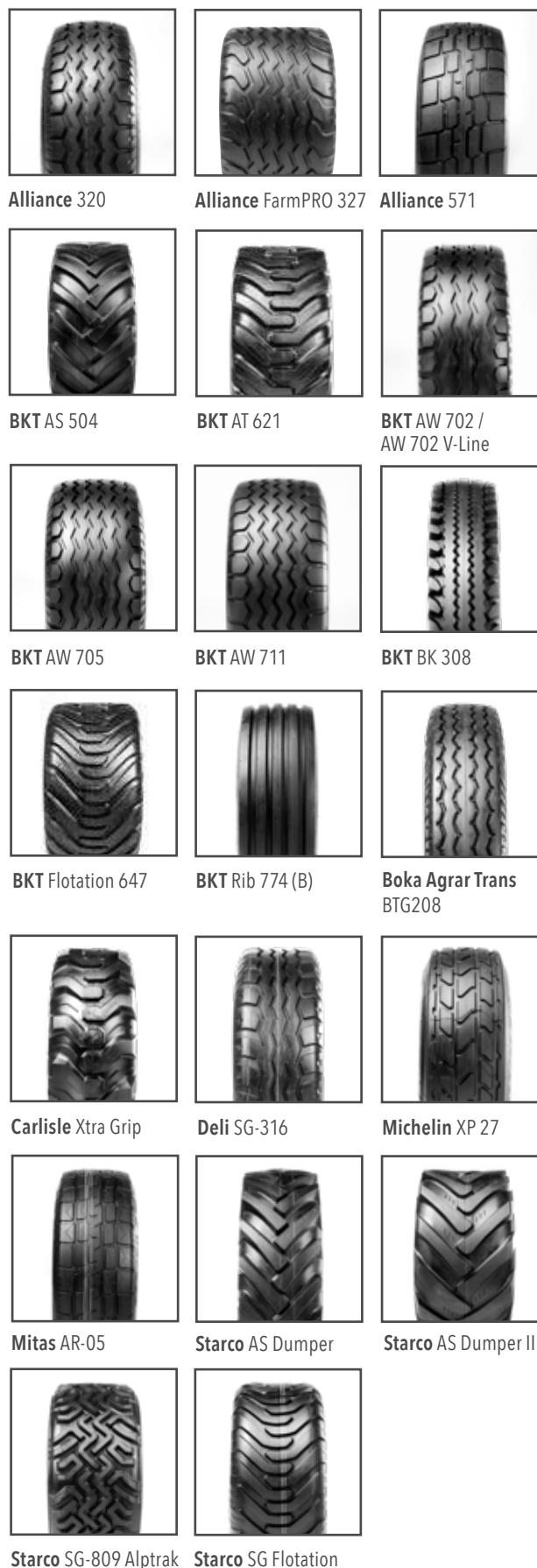

Implementreifen



Implementreifen





Preise und Bestände finden Sie unter www.bohnenkamp.de/shop

Artikel-Nr.	Größe	Last-/ Speed-Index	PR	TL/ TT	Profil	Marke	Felge ¹	Breite in mm	Außen ø in mm
15712471	16.0/70 - 20	151 A8	12 PR	TL	AW 705	BKT	13.0/12/13/14	408	1075
15712472	16.0/70 - 20	156 A8	16 PR	TL	AW 705	BKT	13.0/12/13/14	408	1075
19811075	405/70 - 20	142 A8/154 A8*	14 PR	TL	AS Dumper	Starco	14.00	407	1092
15212550	20.00 - 20	169 A6/165 A8	20 PR	TT	222	Alliance	16/20	498	1400
15216080	500/45 R 20	145 A8/157 A8*		TL	Flotmaster 381	Alliance	16	502	958
15212568	500/55 - 20	138 A8/150 A8*	10 PR	TL	FarmPRO 327	Alliance	16	503	1055
15212559	500/55 - 20	143 A8/155 A8*	12 PR	TL	FarmPRO 327	Alliance	16	503	1058
15215077	500/55 R 20	160 B		TL	Lawn Master 221	Alliance	16	505	1055
15212558	21.0/80 - 20	154 A8/166 A8*	12 PR	TL	222	Alliance	16	525	1384
10001016	24 R 20.5	176 F		TL	392	Alliance	18.00	600	1372
15717300	24 R 20.5	176 F		TL	Ridemax FL 699	BKT	18.00	590	1370
13366470	24 R 20.5	176 F		TL	XS	Michelin	18	602	1374
15222268	15.5/80 - 24	157 A6/154 A8	12 PR	TL	324	Alliance	12/14	384	1262
15712495	15.5/80 - 24	145 A8/157 A8*	12 PR	TL	AS 504	BKT	12/13/14	384	1262
15712493	15.5/80 - 24	151 A8/163 A8*	16 PR	TL	AS 504	BKT	12/13/14	384	1262
15712494	15.5/80 - 24	151 A6	16 PR	TL	Grip Star	BKT	12/13/14	392	1270
15712490	400/80 - 24	162 A8	16 PR	TL	AS 504	BKT	13/12/14	394	1262

* = höhere Tragfähigkeit für Einsatz auf gezogenen Fahrzeugen, niedrigere Tragfähigkeit für Einsatz auf angetriebenen Achsen

¹ = **empfohlene Felge** / weitere zulässige Felgenbreiten

Alles auf einen Blick:

 statischer Halbmesser in mm	 Abrollumfang in mm	 Tragfähigkeit in kg	 km/h	 Luftdruck in bar
480	3155	3450	40	3,00
480	3155	4000	40	4,00
495	3162	2650/3750	40	3,50
598	3991	5800/5150	30/40	3,90
412	2877	2900/4125	40	4,00
464	3063	2360/3350	40	2,40
464	3063	2725/3875	40	3,25
455	3250	4500	50	4,20
573	4080	3750/5300	40	2,20
<hr/>				
619	4210	7100	80	6,00
613	4165	7100	0	6,00
584	4148	7100	80	6,00
<hr/>				
566	3786	4125/3750	30/40	3,00
570	3875	2900/4125	40	3,00
570	3875	3450/4875	40	4,00
569	3683	3450	30	5,20
566	3655	4750	40	5,00



Alliance Lawn Master 221



Alliance 222



Alliance 324



Alliance FarmPRO 327



Alliance Flotmaster 381



Alliance 392



BKT AS 504



BKT AW 705



BKT Grip Star

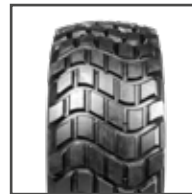

BKT Ridemax FL699



Michelin XS

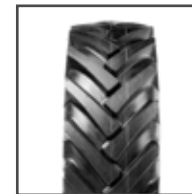

Starco AS Dumper



Anhängerreifen LKW Diagonal

Preise und Bestände finden Sie unter www.bohnenkamp.de/shop

Artikel-Nr.	Größe	Last-/ Speed-Index	PR	TL/TT Set	Profil	Marke	Felge ¹
19966299	7.50 - 15	119/115 K	12 PR	TT/Set	Rib	Boka Truck	6.00 /5.50
19966296	6.00 - 16	102/98 K	10 PR	TT/Set	Rib	Boka Truck	4.00 /4.50
19966297	6.00 - 16	102/98 K	10 PR	TT/Set	Lug	Boka Truck	4.00 /4.50
18365350	6.00 - 16	95/92 L	6 PR	TL	ML914	Security	4.50
19966298	6.50 - 16	110/105 K	12 PR	TT/Set	Rib	Boka Truck	5.50 /4.50/5.00
19966301	7.00 - 16	118/114 K	14 PR	TT/Set	Rib	Boka Truck	5.50 /6.00
19966300	7.50 - 16	122/118 K	14 PR	TT/Set	Rib	Boka Truck	5.50 /6.00
19966335	7.50 - 16	122 D	14 PR	TT/Set	BTG208	Boka Agrar Trans	6.0 /5.50/6.00/6.50
19966302	8.25 - 16	126/122 K	14 PR	TT/Set	Lug	Boka Truck	6.50 /6.00
19966303	8.25 - 16	126/122 K	14 PR	TT/Set	Rib	Boka Truck	6.50 /6.00
19911655	400/45 L - 17.5	156 A8	14 PR	TL	Magic D-905	Magic	14.00
19172460	400/45 L - 17.5	156 B		TL	SG-815	Deli	14.00 /13.00
19966304	7.00 - 20	127/123 G	14 PR	TT/Set	Rib	Boka Truck	5.50 /6.0
19966340	7.00 - 20	127 D	14 PR	TT/Set	BTG208	Boka Agrar Trans	5.5 /5.50/6.0
19966306	7.50 - 20	130/126 G	14 PR	TT/Set	Rib	Boka Truck	6.00 /6.50
19966345	7.50 - 20	130 D	14 PR	TT/Set	BTG208	Boka Agrar Trans	6.0 /6.00/6.50
19966309	8.25 - 20	135/131 G	14 PR	TT/Set	Rib	Boka Truck	6.50 /7.0
19966350	8.25 - 20	136 D	14 PR	TT/Set	BTG208	Boka Agrar Trans	6.5 /6.50/7.0/7.00
19966330	8.25 - 16	126 D	14 PR	TT/Set	BTG208	Boka Agrar Trans	6.5 /6.00
19966311	9.00 - 20	141/136 G	14 PR	TT/Set	Lug	Boka Truck	7.00 /7.0/7.5
19966312	9.00 - 20	141/136 G	14 PR	TT/Set	Rib	Boka Truck	7.00 /7.0/7.5
19966355	9.00 - 20	141 D	14 PR	TT/Set	BTG208	Boka Agrar Trans	7.0 /7.00/7.5/7.50
19966313	10.00 - 20	146/142 G	16 PR	TT/Set	Lug	Boka Truck	7.50 /7.5/8.0
19966314	10.00 - 20	146/142 G	16 PR	TT/Set	Rib	Boka Truck	7.50 /7.5/8.0
19966360	10.00 - 20	146 D	16 PR	TT/Set	BTG208	Boka Agrar Trans	7.5 /7.50/8.0/8.00
19966315	11.00 - 20	149/144 G	16 PR	TT/Set	Lug	Boka Truck	8.00 /8.0/8.5
19966316	11.00 - 20	149/144 G	16 PR	TT/Set	Rib	Boka Truck	8.00 /8.0/8.5
19966365	11.00 - 20	149 D	16 PR	TT/Set	BTG208	Boka Agrar Trans	8.0 /8.00/8.5
19966317	12.00 - 20	154/149 G	18 PR	TT/Set	Lug	Boka Truck	8.5 /8.50/9.0
19966318	12.00 - 20	154/149 G	18 PR	TT/Set	Rib	Boka Truck	8.5 /8.50/9.0
19966370	12.00 - 20	154 D	18 PR	TT/Set	BTG208	Boka Agrar Trans	8.5

¹ = empfohlene Felge / weitere zulässige Felgenbreiten

Alles auf einen Blick:

Breite in mm	Außen ø in mm	Tragfähigkeit in kg	km/h	Luft- druck in bar
215	780	1360/1215	110	6,30
160	740	850/750	110	5,30
160	740	850/750	110	5,30
170	730	690/630	120	4,00
182	755	1060/925	110	6,30
200	775	1320/1180	110	7,30
220	808	1500/1320	110	7,30
202	785	1500	65	7,30
237	856	1700/1500	110	6,30
237	856	1700/1500	110	6,30
397	798	4000	40	6,00
392	770	4000	50	6,00
200	904	1750/1550	90	8,40
203	898	1750	65	8,40
190	910	1900/1700	90	8,10
219	926	1900	65	8,10
234	970	2180/1950	90	8,10
242	974	2240	65	8,10
229	832	1700	65	6,30
280	1059	2575/2240	90	7,70
256	1012	2575/2240	90	7,70
259	1038	2575	65	7,70
278	1054	3000/2650	90	8,10
278	1062	3000/2650	90	8,10
274	1030	3000	65	8,10
316	1128	3250/2800	90	8,10
291	1080	3250/2800	90	8,10
301	1058	3250	65	8,10
340	1170	3750/3250	90	8,10
312	1120	3750/3250	90	8,10
320	1126	3750	65	8,10



Boka Agrar Trans
BTG208

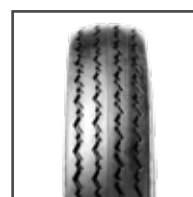

Boka Truck Rib

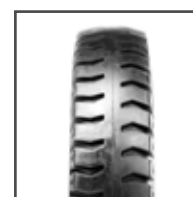

Boka Truck Lug



Deli SG-815



Magic Magic D-905



Security ML914





Anhängerreifen LKW Radial

Preise und Bestände finden Sie unter www.bohnenkamp.de/shop

Artikel-Nr.	Größe	Last-/ Speed-Index	PR	TL/ TT	Profil	Marke	Felge ¹	Breite in mm	Außen ø in mm
10935170	315/55 R 16	124 F/120 K		TL	MPT 81	Continental	10/11	302	750
10000996	9.5 R 17.5	143/141 J	18 PR	TL	SAR1	Sailun	6.75/6	240	842
11366110	385/55 R 19.5	156 J	18 PR	TL	T820	Linglong	12.25/11.75	386	919
11366120	435/50 R 19.5	160 J	20 PR	TL	T820	Linglong	14.00/15.00	438	931
19968005	435/50 R 19.5	165 A8/161 C		TL	Boka Agrar Trans K68	Runderneuert	14.00/15.00	440	930
19968014	435/50 R 19.5	165 A8/161 C		TL	K19	Runderneuert	14.00/15.00	440	930
19968070	435/50 R 19.5	166 A8/161 C		TL	Boka K68	Runderneuert	14.00/15.00	440	955
11366115	445/45 R 19.5	160 J	20 PR	TL	T820	Linglong	15.00/14.00	446	895
10935030	10.5 R 20	134 J	14 PR	TL	MPT 80	Continental	9/8	265	950
10935040	12.5 R 20	132 J	12 PR	TL	MPT 80	Continental	11	320	1030
10935060	12.5 R 20	139 J	16 PR	TL	MPT 80	Continental	11	320	1030
10935071	12.5 R 20	147 J	22 PR	TL	MPT 80	Continental	11	320	1030
10935075	335/80 R 20	147 K		TL	MPT 81	Continental	11/9/10/12	320	1032
10966410	365/80 R 20	152 K		TL	MPT 81	Continental	11/12	378	1089
10935090	14.5 R 20	143 J	18 PR	TL	MPT 80	Continental	11	352	1090
10935111	14.5 R 20	152 J	22 PR	TL	MPT 80	Continental	11	352	1090
19968064	315/80 R 22.5	156/150 M		TL	RE Power WP Alltrac	Runderneuert	9.00/9.75	314	1092
10000906	315/80 R 22.5	157/154 L	20 PR	TL	GMD30	GoodTrip	9.00/9.75	312	1076
10000907	315/80 R 22.5	157/154 L	20 PR	TL	GHA20	GoodTrip	9.00/9.75	312	1076
19968049	385/65 R 22.5	165 D		TL	Boka Agrar Trans I	Runderneuert	11.75	379	1070
19968044	385/65 R 22.5	160 F		TL	Boka Agrar Trans II	Runderneuert	11.75	379	1070
19968059	385/65 R 22.5	160 F		TL	ZA	Runderneuert	11.75	380	1070
19968076	385/65 R 22.5	160 K		TL	RE POWER WP TRUCK	Runderneuert	11.75	385	1068
10466745	385/65 R 22.5	160 K(158 L)	20 PR	TL	WTR 69	Windpower	11.75/12.25	384	1069
10466744	385/65 R 22.5	164 K(158 L)	20 PR	TL	WTR 69+	Windpower	11.75/12.25	384	1069
11066389	385/65 R 22.5	160 K(158 L)	20 PR	TL	STM1	Sailun	11.75/12.25	385	1072
10000884	385/65 R 22.5	164 K		TL	CONTI Hybrid HT3+	Continental	11.75	381	1064
19968069	385/55 R 22.5	158 L/160 J		TL	Boka K19	Runderneuert	12.25	386	997
19968074	425/65 R 22.5	165 G		TL	Agrarmax MZL	Runderneuert	13.00	422	1120
19968075	425/65 R 22.5	165 A8		TL	Boka Agrar Trans SA	Runderneuert		330	1136
11066406	425/65 R 22.5	165 K	20 PR	TL	S825	Sailun	12.25/11.75/13.00	425	1124
10466685	425/65 R 22.5	165 K	20 PR	TL	WTR 69	Windpower	13.00/14.00	421	1119
10466681	425/65 R 22.5	165 K	20 PR	TL	WGC 28	Windpower	13.00/12.25	421	1121
19968072	445/65 R 22.5	169 A8		TL	Boka BS 16	Runderneuert	14.00/13.00	450	1170
11066411	445/65 R 22.5	168 K	20 PR	TL	S825	Sailun	13.00/14.00	444	1150
11066412	445/65 R 22.5	169 K	20 PR	TL	S696	Sailun	13.00/14.00	444	1150
10466693	445/65 R 22.5	169 K	20 PR	TL	WTR 69	Windpower	14.00/13.00	443	1147
10466698	445/65 R 22.5	169 K	20 PR	TL	WGC 28	Windpower	14.00/13.00	450	1148
10436000	445/65 R 22.5	169 F		TL	WGP 23	Windpower	14.00/13.00	438	1178
10436010	445/65 R 22.5	169 F		TL	WE 77	Windpower	14.00/13.00	443	1149
19968090	445/65 R 22.5	168 A8		TL	Boka Agrar Trans SA	Runderneuert	14.00	444	1148
19911657	455/40 R 22.5	160 J		TL	Agrarmax MZL	Runderneuert	15.00/14.00	436	938

¹ = empfohlene Felge / weitere zulässige Felgenbreiten

Alles auf einen Blick:

Tragfähigkeit in kg	km/h	Luft- druck in bar	Roll- wider- stand	Nass- haftung	Rollge- räusch	Rollge- räusch Level	M+S	3PMSF
1600/1400	80/110	3,50	POR				x	
2725/2575	100	8,75	D	B	73	B	x	x
4000	100	9,00	C	B	73	B	x	x
4500	100	9,00	C	B	73	B	x	x
5150/4625	40/60	9,00						
5150/4625	40/60	9,00						
5300/4625	40/60	9,00						
4500	100	9,00	C	B	73	B	x	x
2120	100	5,25	POR				x	
2000	100	3,50	POR				x	
2430	100	4,50	POR				x	
3075	100	6,50	POR				x	
3075	110	6,50	POR				x	
3550	110	6,00	POR				x	
2725	100	4,50	POR				x	
3550	100	6,00	POR				x	
4000/3350	130	8,50					x	x
4125/3750	120	8,30	D	B	73	B	x	x
4125/3750	120	8,30	C	B	70	A	x	x
5150	65	9,00						
4500	80	8,50						
4500	80	9,00						
4500	110	9,00					x	x
4500/4250	110/120	9,00	C	C	72	B	x	x
5000/4250	110/120	9,00	B	C	72	B	x	x
4500/4250	110/120	9,00	D	C	72	A	x	x
5000	110	9,00	B	B	70	A	x	x
4250/4500	120/100	9,00						
5150	90	9,00						
5150	40	9,00						
5150	110	8,30	D	C	72	B	x	x
5150	110	8,30	C	D	71	A	x	x
5150	110	8,30	C	C	74	B	x	x
5800	40	9,00						
5600	110	8,30	D	C	72	B	x	x
5800	110	9,00	C	C	72	B	x	x
5800	110	8,30	C	B	73	B	x	x
5800	110	8,30	C	C	74	B	x	x
5800	80	7,90	POR				x	
5800	80	8,20	POR				x	
5600	40	9,00						
4500	100	9,00						

Continental MPT 80

Continental MPT 81

Continental CONTI Hybrid HT3+

Goodtrip GHA20

Goodtrip GMD30

Linglong T820

Runderneuert Boka Agrar Trans SA

Runderneuert Boka BS 16

Runderneuert K 19 / Boka K 19

Runderneuert Agrarmax MZL

Runderneuert RE Power WP Alltrac

Runderneuert Boka Agrar Trans K 68 / BokAgrar Trans K 68

Runderneuert Boka Agrar Trans II

Sailun S696

Sailun S825

Sailun SAR1

Sailun STM1

Windpower WE 77

Windpower WGP 23

Windpower WGC 28

Windpower WTR 69 / WTR 69+

Implementreifen

168

Erläuterung Flotationreifen

170

Übersicht Flotationreifen Diagonal

172

Übersicht Flotationreifen Radial

176

Flotationreifen Diagonal

182

Flotationreifen Radial

196

Straßenwalzenreifen

198

Industrie Traktorreifen



FLOTATIONREIFEN



Flotationreifen

SERVICE-PLUS BY BOHNENKAMP

Erhalten Sie direkten Zugriff
auf unseren Online-Shop





Aufbau eines Radialreifen

1 Lauffläche:

Die **Lauffläche** ist der meist beanspruchte Teil des Reifens und die Kontaktfläche zum Untergrund.

2 Wulst:

Die **Wulst** verbindet den Reifen mit der Felge. Der Wulstkern besteht hauptsächlich aus Stahldrähten.

3 Inliner:

Als **Inliner** bezeichnet man die innere Wand eines Reifens. Sie verhindert das Entweichen der Luft bei schlauchloser Montage.

4 Karkasse:

Die **Karkasse** ist das Gerüst des Reifens. Sie besteht aus mehreren Gewebeschichten und Nylon (Ausnahme siehe All-Steel-Reifen).

5 Gürtel:

Als **Gürtel** bezeichnet man die gürtelförmigen Lagen unterhalb der Lauffläche. Je nach Material wird von einem Nylon-/Textilgürtel oder Stahlgürtel (Steel Belt) gesprochen (siehe Erläuterung).



Erläuterung der verschiedenen Gürtelarten

Stahlgürtel

Bei einem **Stahlgürtel** werden Stahlmatten eingearbeitet (siehe auch „Steel Belted“). Reifen mit Stahlgürtel bieten – je nach Anzahl der Stahleinlagen – eine höhere Tragkraft und Stabilität. Zusätzlich schützt der Stahlgürtel den Reifen vor äußerlichen

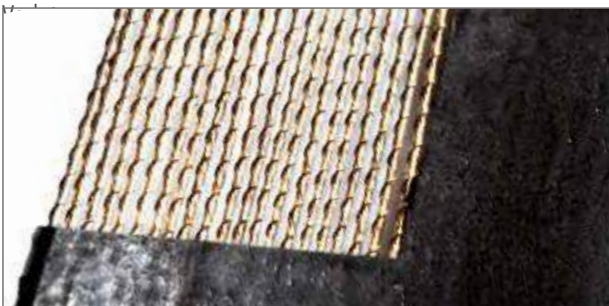

Nylon-/Textilgürtel

Unter der Lauffläche werden **Textil- bzw. Nylonlagen** eingearbeitet. Diese erhöhen die Tragkraft und geben dem Reifen zusätzliche Stabilität.





BODENSCHONER!

Professionelle Flotation-Reifen verringern die Bodenverdichtung

Verstärkung von Flotationreifen

Steel Belted

„Steel Belted“ ist eine andere Bezeichnung für Stahlgürtel. Die so bezeichneten Flotationreifen von Alliance sind durch zwei Stahleinlagen in der Lauffläche verstärkt.



Heavy Duty (HD)

Ein **Heavy Duty (HD)** ist ein Stahlgürtelreifen, der mit einer zusätzlichen Stahleinlage verstärkt ist. HD-Reifen bieten eine sehr hohe Tragkraft und sind besonders widerstandsfähig. Sie sind somit besonders für schwere Erdbewegungsarbeiten geeignet.



All Steel-Reifen

Bei einem **All Steel-Reifen** ist in der Karkasse eine Stahleinlage eingearbeitet, die von Wulst zu Wulst verläuft. Zusätzlich ist der Reifen in der Lauffläche mit einem Stahlgürtel aus drei Stahllagen verstärkt. All Steel Reifen bieten eine sehr hohe Tragkraft und sind aufgrund der durchgängigen Stahlkarkasse auch für sehr lange Transportfahrten mit hohen Geschwindigkeiten bis zu 100 km/h geeignet.*



*Bei sehr langen Transportfahrten mit hohen Geschwindigkeiten kann es zu einer Erwärmung des Gummis in der Seitenwand kommen.

Durch die durchgängige Stahleinlage beim All Steel-Reifen wird die Hitzeentwicklung reduziert, da Stahl die Wärme ableitet.



Übersicht Flotationreifen DIAGONAL



128	Grassland Flotation 221	222	FarmPRO 327	328 Value Plus
800/35 - 22.5	31x15.50 - 15 33x15.50 - 15 450/55 - 17	16.5L - 16.1SL 19.0/45 - 17 20.00 - 20 21.0/80 - 20	500/55 - 20 500/55 - 20 560/60 - 22.5	400/60 - 15.5 500/60 - 22.5 550/45 - 22.5 550/60 - 22.5

Flotation 328	330	Flotation 331
400/60 - 15.5 400/55 - 17.5 400/55 - 22.5 500/45 - 22.5 500/60 - 22.5 550/45 - 22.5 550/60 - 22.5 600/50 - 22.5 600/55 - 22.5 700/50 - 22.5 600/55 - 26.5 700/50 - 26.5 800/45 - 26.5 750/60 - 30.5 850/50 - 30.5	23.1/18 - 26 28L - 26	500/45 - 20 500/60 - 22.5 550/45 - 22.5 550/60 - 22.5 600/40 - 22.5 600/50 - 22.5 600/55 - 22.5 700/40 - 22.5 700/50 - 22.5 600/50 - 26.5 600/55 - 26.5 700/50 - 26.5 800/45 - 26.5 600/60 - 30.5 700/50 - 30.5 800/45 - 30.5



AS 509	Flotation 351	Flotation 558	Flotation 647	Flotation 648
550/45 - 22.5	48x31 - 20 66x43.00 - 25	400/55 - 22.5 400/55 - 22.5 500/45 - 22.5 500/45 - 22.5	260/75 - 15.3 520/50 - 17	500/50 - 17 500/50 - 17 500/55 - 20 385/65 - 22.5 400/60 - 22.5 500/50 - 22.5 500/50 - 22.5 550/45 - 22.5 550/60 - 22.5 550/60 - 22.5 600/50 - 22.5 600/55 - 22.5 700/40 - 22.5 700/50 - 22.5 600/55 - 26.5 700/50 - 26.5 800/45 - 26.5 650/65 - 30.5 750/60 - 30.5 850/50 - 30.5

Flotationreifen



Flotation 648 T	Flotation RIB 774	Flotation TR 675	R 390	TR 678
550/45 - 22.5	550/60 - 22.5 600/55 - 22.5	500/60 - 22.5 500/60 - 22.5 550/60 - 22.5	28L - 26 28 L - 26	280/60 - 15.5 600/40 - 22.5 650/45 - 22.5 710/40 - 22.5



Übersicht Flotationreifen RADIAL



380
Stahlgürtel

Für Transportarbeiten
abseits der Straße



Flotmaster 381
Stahlgürtel

Der Stahlgürtelreifen
für den Grünland-
einsatz



382
Stahlgürtel

Für den landwirtschaft-
lichen LKW-Einsatz

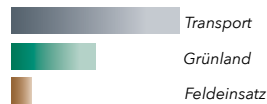

388
Stahlgürtel

Allrounder für den
gemischten Einsatz



Agriflex 389+
Stahlgürtel

Niederdruckreifen mit
großer Aufstandsfläche
für geringeren Bodendruck
bei hoher Tragfähigkeit



All Steel

550/45 R 22.5
560/45 R 22.5
560/60 R 22.5
600/50 R 22.5
600/55 R 22.5
620/40 R 22.5
650/50 R 22.5
710/45 R 22.5
750/45 R 22.5
600/55 R 26.5
600/55 R 26.5
650/55 R 26.5
650/60 R 26.5
710/50 R 26.5
750/45 R 26.5
650/65 R 30.5
750/60 R 30.5

500/50 R 17
500/45 R 20
560/45 R 22.5
560/45 R 22.5
560/45 R 22.5
620/40 R 22.5
620/40 R 22.5
620/50 R 22.5
710/40 R 22.5
620/55 R 26.5
710/50 R 26.5
800/45 R 26.5

400/55 R 22.5
600/50 R 22.5

650/65 R 26.5
710/55 R 34
800/50 R 34

VF 560/60 R 22.5
VF 600/55 R 26.5
VF 650/55 R 26.5
VF 650/60 R 26.5
VF 710/50 R 26.5
VF 750/45 R 26.5
VF 750/60 R 30.5
VF 800/60 R 32

380 Industrial

560/60 R 22.5
600/50 R 22.5
750/45 R 22.5
600/55 R 26.5
650/55 R 26.5

Agriflex 381 +

VF 445/50 R 22.5



Übersicht Flotationreifen RADIAL



FL630 Super
*Stahlgürtel

Für die Traktion im Feld



560/60 R 22.5
580/65 R 22.5
600/50 R 22.5
600/55 R 22.5
600/55 R 26.5
650/55 R 26.5
650/55 R 26.5
650/65 R 26.5
750/45 R 26.5
750/60 R 26.5
650/65 R 30.5
750/60 R 30.5



FL630 Ultra
*Polyestergürtel

Der Reifen für schwere Einsätze im Feld



500/60 R 22.5
560/45 R 22.5
560/60 R 22.5
600/50 R 22.5
600/50 R 22.5
710/40 R 22.5
600/55 R 26.5
650/55 R 26.5
710/50 R 26.5
800/45 R 26.5



FL635
*Polyestergürtel

Der Reifen für den Gründlandeinsatz



620/40 R 22.5
650/55 R 22.5
710/40 R 22.5
750/45 R 22.5



FL637
*Polyestergürtel

Der Reifen für Feld- und Transporteinsatz

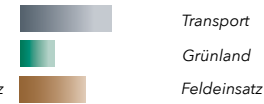

520/50 R 17



FL639
*Polyestergürtel

Für hohe Traglast im Transport- und Traktionseinsatz



560/45 R 22.5
600/50 R 22.5
710/40 R 22.5
850/40 R 26.5



RIB 713

IF-Technologie mit ausgezeichneten Fahreigenschaften auch auf der Straße



IF 280/70 R 15



Ridemax FL 615

Allrounder für Transport- Feld- und Grünland-einsatz

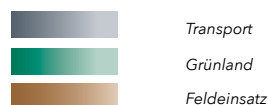

800/65 R 32



Ridemax FL 699

Allrounder für Militär, Erd- bau und landwirtschaft- lichen Transport



525/65 R 20.5
24 R 20.5



Flotationreifen Diagonal





Preise und Bestände finden Sie unter www.bohnenkamp.de/shop

Artikel-Nr.	Größe	Last-/ Speed-Index	PR	TL/ TT	Profil	Marke	Felge ¹	Breite in mm	Außen ø in mm
15211654	400/60 - 15.5	132 A8/145 A8*	14 PR	TL	Flotation 328	Alliance	13.00	404	874
19172430	400/60 - 15.5	132 A8/145 A8*	14 PR	TL	SG-802	Deli	13.00	400	872
19172431	400/60 - 15.5	140 A8/152 A8*	18 PR	TL	SG-802	Deli	13.00	400	874
19172450	380/55 - 17	138 A8/125 A8*	12 PR	TL	SG-802	Deli	13.00	377	872
19811062	480/45 - 17	134 A8/146 A8*	14 PR	TL	SG Flotation	Starco	16.00	451	889
15712428	500/50 - 17	137 A8/149 A8*	14 PR	TL	Flotation 648	BKT	16.00	510	945
15712429	500/50 - 17	145 A8/157 A8*	18 PR	TL	Flotation 648	BKT	16.00	510	945
15712845	520/50 - 17	147 B/159 B*		TL	Flotation 647	BKT	16.00	516	965
19811061	520/50 - 17	147 B/159 B*		TL	SG Flotation	Starco	16.00	510	950
15212250	400/55 - 17.5	136 A8/149 A8*	16 PR	TL	Flotation 328	Alliance	13.00/11.75	393	902
18693730	400/55 - 17.5	119 A8/131 A8*		TT	T404	Trelleborg	11.75	400	880
19811068	425/70 - 18	143 B/155 B		TL	SG Flotation	Starco	13.00	480	1092
15212563	500/45 - 20	134 A8/147 A8*	12 PR	TL	Flotation 331	Alliance	16.00	490	950
15212565	500/45 - 20	164 A6/160 A8	18 PR	TL	Flotation 331	Alliance	16.00	490	980
15212568	500/55 - 20	138 A8/150 A8*	10 PR	TL	FarmPRO 327	Alliance	16.00	503	1055
15212559	500/55 - 20	143 A8/155 A8*	12 PR	TL	FarmPRO 327	Alliance	16.00	503	1058
15712499	500/55 - 20	138 A8/150 A8*	12 PR	TL	Flotation 648	BKT	16.00	508	1058
14813090	500/55 - 20	138 A8/150 A8*		TL	FLOTATION+	Vredestein	16.00	515	1060
15710660	48x31 - 20	148 B	12 PR	TL	Flotation 351	BKT	26.00	775	1283
15212550	20.00 - 20	169 A8/165 B	20 PR	TT	222	Alliance	16/20	498	1400
15712507	385/65 - 22.5	155 A8/167 A8*		TL	Flotation 648	BKT	11.75	400	1070
15212569	400/55 - 22.5	140 A8/152 A8*	16 PR	TL	Flotation 328	Alliance	13.00/11.75	401	1030
15712500	400/55 - 22.5	138 A8/150 A8*	14 PR	TL	Flotation 558	BKT	11.75/12.25/13.00	405	1020
15712502	400/55 - 22.5	140 A8/152 A8*	16 PR	TL	Flotation 558	BKT	11.75/12.25/13.00	405	1020
15712488	400/55 - 22.5	154 A8	18 PR	TL	AW 705	BKT	11.75	405	1016
15712505	400/60 - 22.5	148 A8/160 A8*	18 PR	TL	Flotation 648	BKT	11.75	400	1070
15212575	500/45 - 22.5	142 A8/154 A8*	16 PR	TL	Flotation 328	Alliance	16.00	500	1030
15712510	500/45 - 22.5	136 A8/148 A8*	12 PR	TL	Flotation 558	BKT	16.00	500	1045
15712515	500/45 - 22.5	142 A8/154 A8*	16 PR	TL	Flotation 558	BKT	16.00	500	1045
15712518	500/50 - 22.5	146 A8/158 A8*	16 PR	TL	Flotation 648	BKT	16.00	500	1070
15712522	500/50 - 22.5	151 A8/163 A8*	20 PR	TL	Flotation 648	BKT	16.00	500	1070
15212584	500/60 - 22.5	153 A8/165 A8*	18 PR	TL	Flotation 328	Alliance	16.00	500	1170
15212582	500/60 - 22.5	151 A8/163 A8*	16 PR	TL	Flotation 331	Alliance	16.00	503	1172
15212602	500/60 - 22.5	151 A8/163 A8*	16 PR	TL	328 Value Plus	Alliance	16.00	500	1170
15712527	500/60 - 22.5	145 A8/157 A8*	12 PR	TL	Flotation TR 675	BKT	16.00/15.00/17.00	500	1181
15712528	500/60 - 22.5	151 A8/163 A8*	16 PR	TL	Flotation TR 675	BKT	16.00/15.00/17.00	500	1181
15712526	500/60 - 22.5	151 A8/163 A8*	16 PR	TL	Flotation V-Line	BKT	16.00/15.00/17.00	500	1170
15212590	550/45 - 22.5	141 A8/153 A8*	12 PR	TL	Flotation 331	Alliance	16.00/18.00/20.00	550	1070
15212595	550/45 - 22.5	147 A8/159 A8*	16 PR	TL	Flotation 331	Alliance	16.00/18.00/20.00	550	1070

* = höhere Tragfähigkeit für Einsatz auf gezogenen Fahrzeugen, niedrigere Tragfähigkeit für Einsatz auf angetriebenen Achsen

¹ = empfohlene Felge / weitere zulässige Felgenbreiten

Alles auf einen Blick:

 statischer Halbmesser in mm	 Abrollumfang in mm	 Tragfähigkeit in kg	 km/h	 Luftdruck in bar
377	2510	2000/2900	40	3,60
374	2584	2000/2900	40	3,60
374	2590	2500/3550	40	5,00
376	2547	2360/1650	40	2,80
412	2633	2120/3000	40	3,20
416	2750	2300/3250	40	2,80
416	2750	2900/4125	40	4,00
426	2907	3075/4375	50	4,00
419	2903	3075/4375	50	4,00
418	2709	2240/3250	40	4,00
388	2583	1360/1950	40	2,00
461	3209	2725/3875	50	3,50
433	2820	2120/3075	40	2,80
446	2910	5000/4500	30/40	6,00
464	3063	2360/3350	40	2,40
464	3063	2725/3875	40	3,25
458	3153	2360/3350	40	2,30
475	3160	2360/3350	40	2,40
559	3886	3150	50	2,70
598	3991	5800/5150	40/50	3,90
475	3233	3875/5450	40	5,90
455	3150	2500/3550	40	4,00
445	3084	2360/3350	40	3,50
445	3084	2500/3550	40	4,00
443	3072	3750	40	4,50
475	3233	3150/4500	40	4,30
455	3153	2650/3750	40	3,60
471	3167	2240/3150	40	2,70
471	3167	2650/3750	40	3,60
475	3200	3000/4250	40	3,00
475	3200	3450/4875	40	3,80
510	3470	3650/5150	40	3,60
519	3472	3450/4875	40	3,20
510	3460	3450/4875	40	3,20
534	3505	2900/4125	40	2,40
534	3505	3450/4875	40	4,40
510	3489	3450/4875	40	3,20
488	3271	2575/3650	40	2,10
488	3271	3075/4375	40	2,80



Flotationreifen



Flotationreifen Diagonal





Preise und Bestände finden Sie unter www.bohnenkamp.de/shop

Artikel-Nr.	Größe	Last-/ Speed-Index	PR	TL/ TT	Profil	Marke	Felge ¹	Breite in mm	Außen ø in mm
15212598	550/45 - 22.5	147 A8/159 A8*	16 PR	TL	Flotation 328	Alliance	16.00/18.00	550	1070
15212591	550/45 - 22.5	147 A8/159 A8*	16 PR	TL	328 Value Plus	Alliance	16.00/18.00	550	1070
15712530	550/45 - 22.5	147 A8/159 A8*	16 PR	TL	Flotation 648	BKT	16.00	550	1070
15712532	550/45 - 22.5	154 A8/166 A8*	20 PR	TL	Flotation 648 T	BKT	16.00	550	1070
15712537	550/45 - 22.5	154 A8/166 A8*	20 PR	TL	AS 509	BKT	16.00	540	1065
15212616	550/60 - 22.5	154 A8/166 A8*	16 PR	TL	Flotation 328	Alliance	16.00	550	1238
15212625	550/60 - 22.5	154 A8/166 A8*	16 PR	TL	328 Value Plus	Alliance	16.00	550	1238
15212618	550/60 - 22.5	160 D/159 E	16 PR	TL	Flotation 328	Alliance	16.00	550	1238
15212624	550/60 - 22.5	154 A8/167 A8*	16 PR	TL	Flotation 331	Alliance	16.00	550	1238
15712568	550/60 - 22.5	154 A8/167 A8*	16 PR	TL	Flotation TR 675	BKT	16.00	550	1260
15712565	550/60 - 22.5	154 A8/167 A8*	16 PR	TL	Flotation Rib 774	BKT	16.00	550	1240
15712546	550/60 - 22.5	154 A8/167 A8*	16 PR	TL	Flotation V-Line	BKT	16.00	550	1240
15712556	550/60 - 22.5	156 A8/169 A8*	18 PR	TL	Flotation 648	BKT	16.00	550	1240
15712557	550/60 - 22.5	158 A8/171 A8*	20 PR	TL	Flotation 648	BKT	16.00	550	1240
15212610	560/60 - 22.5	157 A8/169 A8*	16 PR	TL	FarmPRO 327	Alliance	16.00	565	1250
15212646	600/40 - 22.5	142 A8/154 A8*	12 PR	TL	Flotation 331	Alliance	20.00	600	1090
15212643	600/40 - 22.5	173 A6/169 A8	18 PR	TL	Flotation 331	Alliance	20.00	600	1100
15712572	600/40 - 22.5	157 A8/169 A8*	20 PR	TL	TR 678	BKT	20.00	615	1085
15212638	600/50 - 22.5	158 D/157 E	16 PR	TL	Flotation 328	Alliance	20.00	600	1170
15212639	600/50 - 22.5	153 A8/165 A8*	16 PR	TL	Flotation 331	Alliance	20.00	600	1170
15212644	600/50 - 22.5	174 A6/170 A8	18 PR	TL	Flotation 331	Alliance	20.00	600	1170
15712575	600/50 - 22.5	153 A8/165 A8*	16 PR	TL	Flotation 648	BKT	20.00	600	1170
15212648	600/55 - 22.5	162 D/161 E	16 PR	TL	Flotation 328	Alliance	20.00	600	1270
15212635	600/55 - 22.5	156 A8/169 A8*	16 PR	TL	Flotation 331	Alliance	20.00	602	1270
15712585	600/55 - 22.5	156 A8/169 A8*	16 PR	TL	Flotation 648	BKT	20.00	600	1230
15712595	600/55 - 22.5	156 A8/169 A8*	16 PR	TL	Flotation Rib 774	BKT	20.00	600	1230
15712597	650/45 - 22.5	166 B	20 PR	TL	TR 678	BKT	20.00	650	1150
15212621	700/40 - 22.5	177 A6/173 A8	18 PR	TL	Flotation 331	Alliance	24.00	700	1230
15712605	700/40 - 22.5	154 A8/166 A8*	16 PR	TL	Flotation 648	BKT	24.00	700	1170
15212670	700/50 - 22.5	167 D/166 E	16 PR	TL	Flotation 328	Alliance	24.00	700	1270
15212655	700/50 - 22.5	162 A8/174 A8*	16 PR	TL	Flotation 331	Alliance	24.00	700	1270
15712615	700/50 - 22.5	162 A8/174 A8*	16 PR	TL	Flotation 648	BKT	24.00	700	1270
15712608	710/40 - 22.5	173 A8		TL	TR 678	BKT	24.00	707	1165
14812630	710/45 - 22.5	171 A8	16 PR	TL	FLOTATION+	Vredestein	24.00	730	1240
15212674	800/35 - 22.5	169 A8/162 D	16 PR	TL	128	Alliance	28.00/24.00/26.00	800	1170
15712672	66x43.00 - 25	170 B	16 PR	TL	Flotation 351	BKT	36.0	1020	1750
15222357	23.1/18 - 26	168 A8	16 PR	TL	330	Alliance	20	587	1560
15222391	28L - 26	173 A8	16 PR	TL	330	Alliance	25	714	1590
10000927	28L - 26	160 A6/157 A8	16 PR	TL	TR 390	BKT	25/23	714	1560
15772457	28 L - 26	172 A6/168 A8	20 PR	TL	TR 390	BKT	25/23	714	1560

* = höhere Tragfähigkeit für Einsatz auf gezogenen Fahrzeugen, niedrigere Tragfähigkeit für Einsatz auf angetriebenen Achsen

¹ = empfohlene Felge / weitere zulässige Felgenbreiten

Alles auf einen Blick:

				
statischer Halbmesser in mm	Abrollumfang in mm	Tragfähigkeit in kg	km/h	Luftdruck in bar
476	3175	3075/4375	40	2,80
470	3105	3075/4375	40	3,80
475	3203	3075/4375	40	2,80
475	3203	3750/5300	40	4,00
479	3250	3750/5300	40	4,00
540	3765	3750/5300	40	3,00
540	3765	3750/5300	40	3,00
540	3580	4500/4375	65/70	2,80
540	3740	3750/5450	40	2,80
547	3640	3750/5450	40	3,80
540	3725	3750/5450	40	2,80
540	3725	3750/5450	40	2,80
540	3725	4000/5800	40	3,20
540	3725	4250/6150	40	3,50
547	3618	4125/5800	40	3,75
480	3356	2650/3750	40	2,10
505	3280	6500/5800	30/40	6,00
483	3264	4125/5800	40	4,10
520	3450	4250/4125	65/70	2,60
510	3470	3650/5150	40	2,60
533	3470	6700/6000	30/40	6,00
510	3501	3650/5150	40	2,60
550	3650	4750/4625	65/70	2,80
533	3580	4000/5800	40	2,60
540	3716	4000/5800	40	2,60
540	3716	4000/5800	40	2,60
502	3302	5300	50	4,50
559	3727	7300/6500	30/40	6,00
510	3537	3750/5300	40	2,20
550	3650	5450/5300	65/70	2,80
550	3650	4750/6700	40	2,40
550	3775	4750/6700	40	2,40
545	3624	6500	40	6,00
550	3700	6150	40	2,80
523	3508	5800/4750	40/65	2,60
782	5213	6000	50	2,80
690	4545	5600	40	2,30
702	4627	6500	40	2,20
690	4545	4500/4125	30/40	1,90
690	4545	6300/5600	30/40	2,80



Alliance 128



Alliance FarmPRO 327



Alliance Flotation 328



Alliance 328 Value Plus



Alliance 330

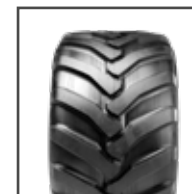

Alliance Flotation 331



BKT AS 509



BKT Flotation 351



BKT Flotation 648 / Flotation 648 T



BKT Flotation Rib 774



BKT TR 390



BKT Flotation TR 675



BKT TR 678



BKT Flotation V-Line



Vredestein FLOTATION +



Flotationreifen Diagonal

Preise und Bestände finden Sie unter www.bohnenkamp.de/shop

Artikel-Nr.	Größe	Last-/Speed-Index	PR	TL/TT	Profil	Marke	Felge ¹	Breite in mm	Außen ø in mm
18622340	400/60 - 26.5	135 A8/147 A8*		TT	T404	Trelleborg	13.00	400	1160
15212711	600/50 - 26.5	155 A8/167 A8*	16 PR	TL	Flotation 331	Alliance	20.00	600	1270
15212741	600/55 - 26.5	159 A8/170 A8*	16 PR	TL	Flotation 331	Alliance	20.00	591	1333
15212721	600/55 - 26.5	167 B/163 C	16 PR	TL	Flotation 328	Alliance	20.00	600	1333
15712825	600/55 - 26.5	159 A8/170 A8*	16 PR	TL	Flotation 648	BKT	20.00	600	1354
15212831	700/50 - 26.5	170 B/166 C	16 PR	TL	Flotation 328	Alliance	24.00	700	1333
15212820	700/50 - 26.5	162 A8/174 A8*	16 PR	TL	Flotation 331	Alliance	24.00	700	1333
15712855	700/50 - 26.5	162 A8/174 A8*	16 PR	TL	Flotation 648	BKT	24.00	700	1354
15212870	800/45 - 26.5	164 A8/177 A8*	16 PR	TL	Flotation 328	Alliance	28.00	800	1393
15212880	800/45 - 26.5	164 A8/177 A8*	16 PR	TL	Flotation 331	Alliance	28.00	800	1393
15712885	800/45 - 26.5	164 A8/177 A8*	16 PR	TL	Flotation 648	BKT	28.00	800	1354
15213510	600/60 - 30.5	161 A8/174 A8*	16 PR	TL	Flotation 331	Alliance	20.00	600	1500
15712910	650/65 - 30.5	167 A8/179 A8*	16 PR	TL	Flotation 648	BKT	20.00	650	1650
15213560	700/50 - 30.5	163 A8/176 A8*	16 PR	TL	Flotation 331	Alliance	24.00	700	1515
15213575	750/60 - 30.5	179 B/172 D	16 PR	TL	Flotation 328	Alliance	24.00	750	1670
15712930	750/60 - 30.5	170 A8/182 A8*	16 PR	TL	Flotation 648	BKT	24.00	750	1650
15213600	800/45 - 30.5	167 A8/179 A8*	16 PR	TL	Flotation 331	Alliance	28.00	800	1500
15213612	850/50 - 30.5	174 A8/186 A8*	16 PR	TL	Flotation 328	Alliance	28.00	850	1670

* = höhere Tragfähigkeit für Einsatz auf gezogenen Fahrzeugen, niedrigere Tragfähigkeit für Einsatz auf angetriebenen Achsen

¹ = empfohlene Felge / weitere zulässige Felgenbreiten



Alles auf einen Blick:

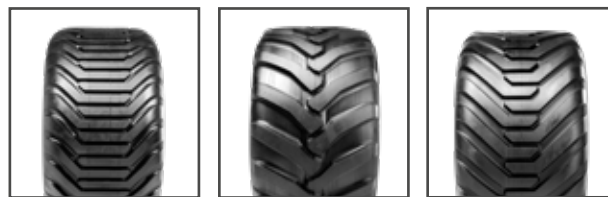

Alliance Flotation 328 Alliance Flotation 331 BKT Flotation 648



Trelleborg T404

statischer Halbmesser in mm	Abrollumfang in mm	Tragfähigkeit in kg	km/h	Luftdruck in bar
525	3470	2180/3075	40	2,40
560	3694	3875/5450	40	2,60
580	3850	4375/6000	40	2,60
580	3850	5450/4875	50/60	2,60
581	4017	4375/6000	40	2,60
580	3974	6000/5300	50/60	2,40
580	3976	4750/6700	40	2,40
581	4017	4750/6700	40	2,40
614	4050	5000/7300	40	2,20
614	4051	5000/7300	40	2,20
581	4017	5000/7300	40	2,20
655	4340	4625/6700	40	2,60
710	4935	5450/7750	40	2,20
684	4590	4875/7100	40	2,20
720	4790	7750/6300	50/65	2,50
710	4935	6000/8500	40	2,20
655	4561	5450/7750	40	2,20
720	4790	6700/9500	40	2,20



1 Mio. Reifen. 100% Service.



Europas größter Online-Service-Shop für Agrar-, Industrie-, EM-, LKW und Kleinreifen

www.bohnenkamp.de



Flotationreifen Radial





Preise und Bestände finden Sie unter www.bohnenkamp.de/shop

Artikel-Nr.	Größe	Last-/ Speed-Index	TL/ TT	Profil	Marke	Felge ¹	Breite in mm	Außen ø in mm
15717150	IF 280/70 R 15	128 D	TL	Rib 713	BKT	8	279	779
15711841	380/55 R 16.5	150 A8/150 B	TL	AW 711	BKT	12/11.75	360	830
15717218	425/55 R 17	140 A8/129 D	TL	Ridemax FL 693 M	BKT	13.00	420	894
15717220	440/50 R 17	135 D	TL	Trac Super	BKT	14.00/13.00	441	872
15216051	500/50 R 17	149 D	TL	Flotmaster 381	Alliance	16.00	494	950
15215505	500/50 R 17	149 D	TL	882	Alliance	16.00	503	932
15717230	500/50 R 17	149 D/146 E	TL	Ridemax FL 693 M	BKT	16.00	503	932
10000073	VF 500/50 R 17	156 D	TL	Ridemax FL 693 M	BKT	16.00	503	932
15717240	520/50 R 17	151 D/148 E	TL	FL 637	BKT	16.00	516	952
15715080	VF 400/45 R 17.5	159 D	TL	Ridemax FL 693 M	BKT	14.00	400	800
10000070	525/65 R 20.5	173 F	TL	Ridemax FL 699	BKT	16.00/18.00	518	1200
13366470	24 R 20.5	176 F	TL	XS	Michelin	18	602	1374
15215520	385/65 R 22.5	164 D	TL	882	Alliance	11.75	389	1075
15215490	400/55 R 22.5	146 J	TL	382	Alliance	13.00/11.75	404	1020
15216106	VF 445/50 R 22.5	167 D	TL	Agriflex 381 +	Alliance	14.00	437	1016
15216272	445/65 R 22.5	160 J	TL	398	Alliance	14.00/13.00	455	1166
15715090	VF 445/65 R 22.5	169 D	TL	SR 713	BKT	13.00/14.00	440	1160
10915500	460/65 R 22.5	156 A8/168 A8*	TL	AR-01	Mitas	14.00	475	1142
15715100	500/45 R 22.5	146 D/143 E	TL	Ridemax FL 693 M	BKT	16.00	503	1022
10000865	500/60 R 22.5	163 D	TL	Ridemax FL 693 M	BKT	16.00/15.00/17.00	503	1172
15215525	500/60 R 22.5	155 D	TL	390	Alliance	16.00	510	1180
15215524	500/60 R 22.5	155 D	TL	882	Alliance	16.00	510	1180
15715106	500/60 R 22.5	166 A8/155 D	TL	FL 630 Ultra	BKT	16.00/15.00/17.00	503	1172
15715121	500/60 R 22.5	155 D/152 E	TL	Ridemax FL 693 M	BKT	16/15/17	503	1172
13316150	VF 500/60 R 22.5	160 D	TL	TrailXBib	Michelin	16.00/15.00/17.00	501	1173
10915520	500/60 R 22.5	161 D	TL	Agriterra 02	Mitas	16.00/15.00/17.00	524	1172
17415575	500/60 R 22.5	155 D	TL	Country King	Nokian	16.00/14.00/15.00/17.00	503	1172
13615150	500/60 R 22.5	155 D	TL	Twin Radial	Trelleborg	16.00/15.00/17.00	520	1192
15215510	550/45 R 22.5	151 E	TL	380	Alliance	16.00	550	1070
15216112	560/45 R 22.5	146 D	TL	Flotmaster 381	Alliance	16.00	540	1080
15216110	560/45 R 22.5	146 D	TL	Flotmaster 381	Alliance	16.00	540	1080
15216111	560/45 R 22.5	146 D	TL	Flotmaster 381	Alliance	16.00	540	1080
15215513	560/45 R 22.5	152 D	TL	380	Alliance	16.00	543	1075
15215515	560/45 R 22.5	152 D	TL	390	Alliance	16.00	545	1078
15216211	560/45 R 22.5	152 D	TL	885	Alliance	16.00	543	1060
15215522	560/45 R 22.5	152 D	TL	882	Alliance	16.00	543	1076
15715113	560/45 R 22.5	163 A8/152 D	TL	FL 630 Ultra	BKT	16.00	543	1076
15715116	560/45 R 22.5	152 D	TL	Ridemax FL 693 M	BKT	16.00	543	1076
15715118	560/45 R 22.5	163 A8/152 D	TL	FL 639	BKT	16.00	543	1076

Heavy Duty = Heavy Duty (verstärkte Ausführung)

¹ = **empfohlene Felge** / weitere zulässige Felgenbreiten

Alles auf einen Blick:

 statischer Halbmesser in mm	 Abrollumfang in mm	 Tragfähigkeit in kg	 km/h	 Luftdruck in bar
347	2356	1800	65	3,60
372	2500	3350	40/50	5,00
397	2704	2500/1850	40/65	4,00
395	2674	2180	65	3,60
421	2870	3250	65	4,50
409	2833	3250	65	5,00
424	2913	3250/3000	65/70	5,00
422	2880	4000	65	5,00
414	2930	3450/3150	65/70	5,00
357	2448	4375	65	6,00
544	3678	6500	80	8,00
584	4148	7100	80	6,00
493	3205	5000	65	9,00
474	3150	3000	100	6,00
454	3123	5450	65	6,70
532	3592	4500	100	6,00
533	3515	5800	65	4,40
512	3420	4000/5600	40	5,00
455	3114	3000/2725	65/70	4,00
544	3625	4875	65	6,00
529	3616	3875	65	4,00
529	3616	3875	65	4,00
521	3592	5300/3875	40/65	4,00
531	3577	3875/3550	65/70	4,00
493	3433	4500	65	3,20
543	3547	4625	65	6,00
521	3581	3875	65	4,00
537	3600	3875	65	4,00
489	3275	3450	70	4,00
485	3295	3000	65	3,20
485	3304	3000	65	3,20
485	3295	3000	65	3,20
485	3265	3550	65	4,00
483	3291	3550	65	4,00
478	3260	3550	65	4,00
485	3310	3550	65	4,00
490	3290	4875/3550	40/65	4,00
457	3306	3550	65	4,00
484	3303	4875/3550	40/65	4,00

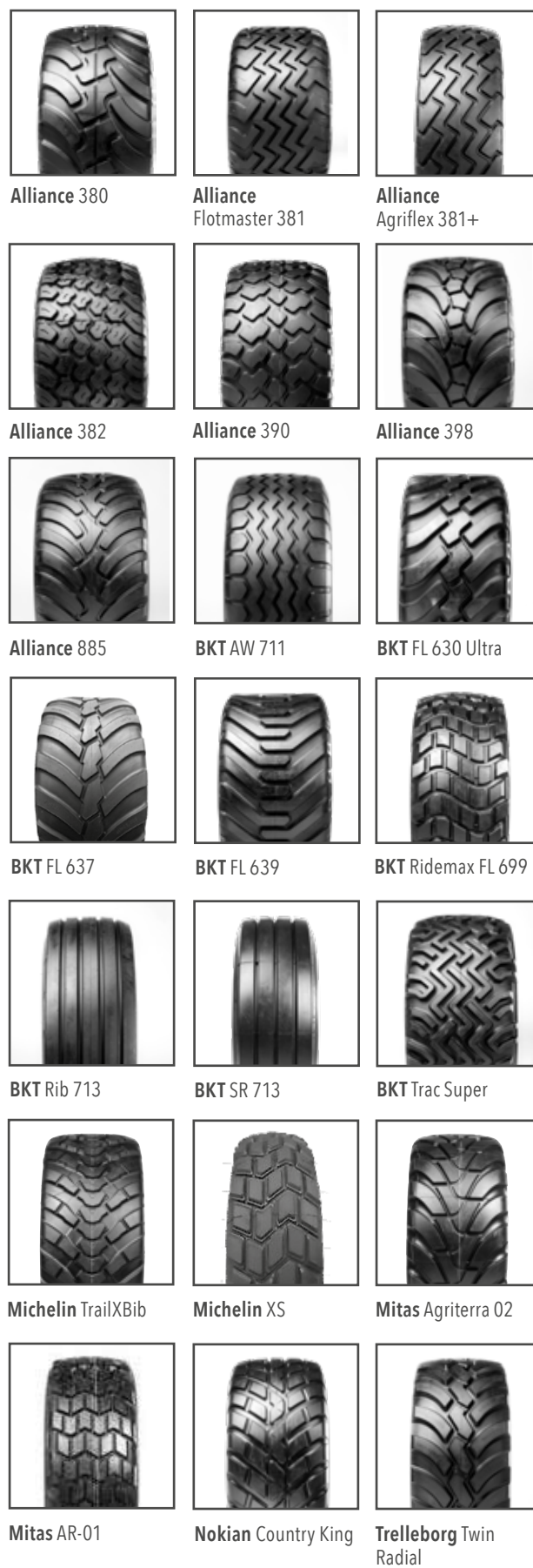

Flotationreifen



Flotationreifen Radial





Preise und Bestände finden Sie unter www.bohnenkamp.de/shop

Artikel-Nr.	Größe	Last- / Speed-Index	TL/ TT	Profil	Marke	Felge ¹	Breite in mm	Außen ø in mm
10915530	560/45 R 22.5	152 D	TL	Agriterra 02	Mitas	16.00	564	1076
17415555	560/45 R 22.5	152 D	TL	Country King	Nokian	16.00	564	1076
14815152	560/45 R 22.5	152 D	TL	FLOTATION PRO	Vredestein	16.00	545	1085
15715119	560/55 R 22.5	158 D/155 E	TL	Ridemax FL 693 M	BKT	16.00/17.00/20.00	543	1180
15215536	VF 560/60 R 22.5	163 D	TL	Agriflex 389 +	Alliance	16.00	565	1250
15215530	560/60 R 22.5	164 D	TL	390	Alliance	16.00	572	1252
15216225	560/60 R 22.5	164 D	TL	885	Alliance	16.00	555	1230
15215531	560/60 R 22.5	165 D	TL	882	Alliance	16.00	565	1244
15215600	560/60 R 22.5	161 E	TL	380	Alliance	16.00	554	1245
10000946	560/60 R 22.5	169 D	TL	590	Alliance	16.00	550	1244
15215533	560/60 R 22.5	170 D	TL	390 Industrial HD	Alliance	16.00	556	1252
15215534	560/60 R 22.5	172 D	TL	380 Industrial HD	Alliance	16.00	550	1249
15715136	560/60 R 22.5	161 D	TL	FL 630 Super	BKT	16.00/17.00	543	1244
15715139	560/60 R 22.5	172 A8/161 D	TL	FL 630 Ultra	BKT	16.00/17.00/20.00	543	1244
15715143	560/60 R 22.5	165 D/162 E	TL	Ridemax FL 693 M	BKT	16.00/17.00	543	1244
15715650	VF 560/60 R 22.5	166 D	TL	V-Flexa	BKT	16.00	555	1250
13316170	560/60 R 22.5	166 D	TL	TrailXBib	Michelin	16.00/17.00/18.00/20.00	542	1242
10915537	560/60 R 22.5	165 D	TL	Agriterra 02	Mitas	16.00/20.00	567	1247
17415580	560/60 R 22.5	161 D	TL	Country King	Nokian	16.00/15.00/17.00/20.00	564	1244
17415850	560/60 R 22.5	165 D	TL	CT	Nokian	16.00/18.00	560	1245
13615160	560/60 R 22.5	161 D	TL	Twin Radial	Trelleborg	16.00/17.00	552	1240
14815165	560/60 R 22.5	161 D	TL	FLOTATION PRO	Vredestein	16.00	565	1250
15216232	580/65 R 22.5	166 D	TL	885	Alliance	16.00	574	1315
15215537	580/65 R 22.5	166 D	TL	882	Alliance	16.00	575	1326
15715137	580/65 R 22.5	166 D	TL	FL 630 Super	BKT	18.00/16.00/17.00/20.00	577	1326
15715128	580/65 R 22.5	166 D/163 E	TL	Ridemax FL 693 M	BKT	18.00/16.00/20.00	577	1326
17415585	580/65 R 22.5	166 D	TL	Country King	Nokian	16.00/18.00	577	1300
13615170	580/65 R 22.5	159 D	TL	Twin Radial	Trelleborg	16.00/17.00/20.00	583	1300
15215540	600/45 R 22.5	165 A8/161 B	TL	Flotation 331	Alliance	20.00	608	1152
15215560	600/50 R 22.5	174 A8/171 B	TL	390 Industrial HD	Alliance	20.00	605	1168
15216241	600/50 R 22.5	159 D	TL	885	Alliance	20.00	606	1172
15215579	600/50 R 22.5	167 D	TL	380 Industrial HD	Alliance	20.00	611	1172
15215570	600/50 R 22.5	159 E	TL	390	Alliance	20.00	583	1171
15215562	600/50 R 22.5	159 E	TL	882	Alliance	20.00	611	1172
15215566	600/50 R 22.5	166 F	TL	390	Alliance	20.00	585	1180
15215580	600/50 R 22.5	164 J	TL	380	Alliance	20.00	608	1172
15215572	600/50 R 22.5	164 J	TL	382	Alliance	20.00	600	1170
15216303	600/50 R 22.5	164 J	TL	398	Alliance	20.00	620	1172
15715146	600/50 R 22.5	159 D	TL	FL 630 Super	BKT	20.00	611	1170

HD = Heavy Duty (verstärkte Ausführung)

¹ = **empfohlene Felge** / weitere zulässige Felgenbreiten

Alles auf einen Blick:

 statischer Halbmesser in mm	 Abrollumfang in mm	 Tragfähigkeit in kg	 km/h	 Luftdruck in bar
495	3228	3550	65	4,00
474	3280	3550	65	4,00
490	3295	3550	65	4,00
533	3614	4250/3875	65/70	4,00
538	3759	4875	65	2,80
558	3671	5000	65	4,00
553	3620	5000	65	4,00
555	3650	5150	65	4,20
559	3800	4625	70	4,00
563	3775	5800	65	6,00
559	3834	6000	65	5,00
553	3849	6300	65	5,00
549	3785	4625	65	4,00
535	3760	6300/4625	40/65	4,00
552	3767	5150/4750	65/70	5,00
550	3756	5300	65	3,20
507	3612	5300	65	3,20
568	3743	5150	65	5,00
557	3764	4625	65	4,00
555	3811	5150	65	5,00
559	3824	4625	65	4,00
560	3850	4625	65	3,20
580	4040	5300	65	4,00
588	4030	5300	65	4,00
594	4058	5300	65	4,00
572	4031	5300/4875	65/70	4,00
586	3977	5300	65	4,00
586	3950	4375	65	3,20
511	3502	5150/4625	40/50	4,00
527	3450	6700/6150	40/50	6,50
532	3470	4375	65	4,00
527	3588	5450	65	5,00
531	3605	4375	70	4,00
527	3473	4375	70	4,00
539	3510	5300	80	6,00
527	3611	5000	100	6,50
535	3587	5000	100	6,50
541	3605	5000	100	6,50
518	3533	4375	65	4,00



Alliance Flotation 331

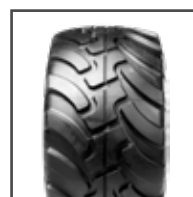

Alliance 380 /
380 Industrial HD

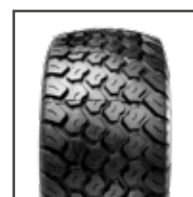

Alliance 382

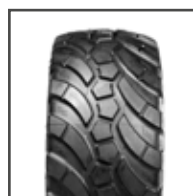

Alliance
Agriflex 389 +



Alliance 390 /
390 Industrial HD



Alliance 398



Alliance 590



Alliance 882

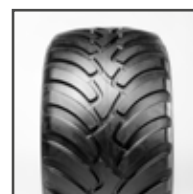

Alliance 885



BKT FL 630 Super



BKT FL 630 Ultra



BKT Ridemax FL
693 M

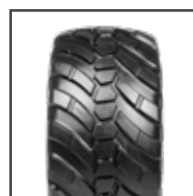

BKT V-Flexa



Michelin TrailXBib



Mitas Agriterra 02

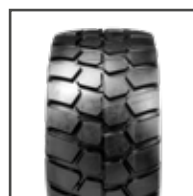

Nokian CT

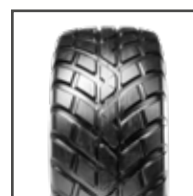

Nokian Country King



Trelleborg Twin
Radial



Vredestein
FLOTATION PRO



Flotationreifen Radial





Preise und Bestände finden Sie unter www.bohnenkamp.de/shop

Artikel-Nr.	Größe	Last-/ Speed-Index	TL/ TT	Profil	Marke	Felge ¹	Breite in mm	Außen ø in mm
15715142	600/50 R 22.5	170 A8/159 D	TL	FL 630 Ultra	BKT	20.00	611	1172
15715129	600/50 R 22.5	170 A8/159 D	TL	FL 639	BKT	20.00	611	1172
15715133	600/50 R 22.5	159 D/156 E	TL	Ridemax FL 693 M	BKT	20.00	611	1172
13316180	VF 600/50 R 22.5	164 D	TL	TrailXBib	Michelin	20.00	617	1172
10915550	600/50 R 22.5	163 D	TL	Agriterra 02	Mitas	20.00	631	1173
10915552	600/50 R 22.5	167 D	TL	Agriterra 02	Mitas	20.00	631	1173
17415565	600/50 R 22.5	159 D	TL	Country King	Nokian	20.00	600	1172
17415860	600/50 R 22.5	163 D	TL	CT	Nokian	20.00	605	1173
10001038	600/50 R 22.5	159 D	TL	Twin Radial	Trelleborg	20.00	600	1170
15215630	600/55 R 22.5	162 E	TL	380	Alliance	20.00	600	1245
15715145	600/55 R 22.5	162 D	TL	FL 630 Super	BKT	20.00	595	1232
15216131	620/40 R 22.5	148 D	TL	Flotmaster 381	Alliance	20.00	612	1080
15216125	620/40 R 22.5	154 D	TL	Flotmaster 381	Alliance	20.00	612	1080
15215642	620/40 R 22.5	155 D	TL	380	Alliance	20.00	620	1072
15715138	620/40 R 22.5	154 D	TL	FL 635	BKT	20.00	625	1068
14815170	620/40 R 22.5	148 D	TL	FLOTATION PRO	Vredestein	20.00	610	1080
14815175	620/40 R 22.5	154 D	TL	FLOTATION PRO	Vredestein	20.00	610	1090
15216142	620/50 R 22.5	161 D	TL	Flotmaster 381	Alliance	20.00	600	1170
14815180	620/50 R 22.5	154 D	TL	FLOTATION PRO	Vredestein	20.00	610	1185
14815185	620/50 R 22.5	161 D	TL	FLOTATION PRO	Vredestein	20.00	610	1185
15216249	650/50 R 22.5	163 D	TL	885	Alliance	20.00	650	1235
15215650	650/50 R 22.5	163 E	TL	380	Alliance	20.00	650	1235
15715134	650/50 R 22.5	163 D/160 E	TL	Ridemax FL 693 M	BKT	20.00	645	1222
17415570	650/50 R 22.5	163 D	TL	Country King	Nokian	20.00	645	1237
14815195	650/50 R 22.5	163 D	TL	FLOTATION PRO	Vredestein	20.00	645	1250
15715150	650/55 R 22.5	167 D	TL	FL 635	BKT	20.00	645	1287
10001262	710/35 R 22.5	157 D	TL	882	Alliance	24.00	712	1069
15715166	710/35 R 22.5	157 D/154 E	TL	Ridemax FL 693 M	BKT	24.00	712	1070
17415550	710/35 R 22.5	157 D	TL	Country King	Nokian	24.00	712	1069
15216163	710/40 R 22.5	162 D	TL	Flotmaster 381	Alliance	24.00	702	1161
15715141	710/40 R 22.5	172 A8/161 D	TL	FL 630 Ultra	BKT	24.00	727	1140
15715140	710/40 R 22.5	172 A8/161 D	TL	FL 639	BKT	24.00	727	1140
15715168	710/40 R 22.5	161 D	TL	FL 635	BKT	24.00	727	1140
14815205	710/40 R 22.5	161 D	TL	FLOTATION PRO	Vredestein	24.00	705	1140
15215657	710/45 R 22.5	165 D	TL	380	Alliance	24.00	727	1210
15216245	710/45 R 22.5	165 D	TL	885	Alliance	24.00	725	1210
15715169	710/45 R 22.5	165 D	TL	Ridemax FL 693 M	BKT	24.00	706	1212
13316190	VF 710/45 R 22.5	170 D	TL	TrailXBib	Michelin	24.00	717	1214
10915570	710/45 R 22.5	165 D	TL	Agriterra 02	Mitas	24.00	729	1208

Industrial HD = Industrial Heavy Duty (verstärkte Ausführung)

¹ = empfohlene Felge

Alles auf einen Blick:

 statischer Halbmesser in mm	 Abrollumfang in mm	 Tragfähigkeit in kg	 km/h	 Luftdruck in bar
518	3533	6000/4375	40/65	4,00
521	3592	6000/4375	40/65	4,00
516	3574	4375/4000	65/70	4,00
485	3419	5000	65	3,20
537	3530	4875	65	5,00
537	3530	5450	65	6,00
533	3575	4375	65	4,00
528	3574	4875	65	5,00
530	3550	4375	65	4,50
562	3807	4750	70	4,00
560	3757	4750	65	4,00
486	3295	3150	65	3,20
486	3278	3750	65	4,00
488	3352	3875	65	4,00
470	3249	3750	65	4,00
495	3330	3150	65	3,20
495	3330	3750	65	4,00
520	3601	4625	65	4,00
540	3640	3750	65	3,20
540	3640	4625	65	4,00
554	3630	4875	65	4,00
554	3798	4875	70	4,00
535	3715	4875/4500	65/70	4,00
564	3789	4875	65	4,00
560	3850	4875	65	4,00
568	3901	5450	65	4,00
481	3263	4125	65	4,00
482	3254	4125/3750	65/70	4,00
484	3248	4125	65	4,00
521	3582	4750	65	4,00
514	3490	6300/4625	40/65	4,00
503	3492	6300/4625	40/65	4,00
510	3467	4625	65	4,00
520	3520	4625	65	4,00
534	3683	5150	65	4,00
535	3675	5150	65	4,00
542	3658	5150	65	4,00
	3562	6000	65	3,20
545	3610	5150	65	4,00



Alliance 380



Alliance
Flotmaster 381

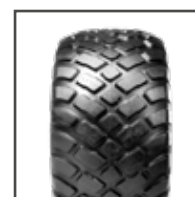

Alliance 882

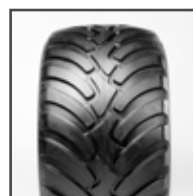

Alliance 885



BKT FL 630 Super



BKT FL 630 Ultra



BKT FL 635



BKT FL 639



BKT Ridemax
FL 693 M

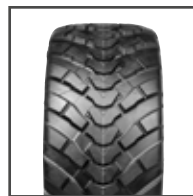

Michelin TrailXBib



Mitas Agriterra 02



Nokian CT

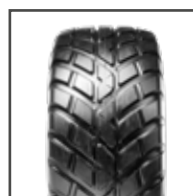

Nokian Country King



Trelleborg Twin
Radial

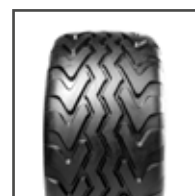

Vredestein
FLOTATION PRO



Flotationreifen Radial

Preise und Bestände finden Sie unter www.bohnenkamp.de/shop

Artikel-Nr.	Größe	Last- / Speed-Index	TL/ TT	Profil	Marke	Felge ¹	Breite in mm	Außen ø in mm
17415560	710/45 R 22.5	165 D	TL	Country King	Nokian	24.00	727	1212
14816100	710/45 R 22.5	165 D	TL	FLOTATION TRAC	Vredestein	24.00	730	1230
15215660	750/45 R 22.5	166 E	TL	380	Alliance	24.00	750	1245
15215662	750/45 R 22.5	177 D/174 E	TL	380 Industrial HD	Alliance	24.00	745	1250
15715170	750/45 R 22.5	168 D	TL	FL 635	BKT	24.00	754	1247
15215670	620/75 R 26	174 D	TL	390	Alliance	20	620	1590
15215825	28L R 26	176 A8/173 B	TL	390	Alliance	25	727	1542
15715180	28L R 26	176 A8/173 B	TL	Ridemax FL 690	BKT	25/23	719	1590
15215690	600/55 R 26.5	165 E	TL	380	Alliance	20.00	625	1346
15215689	600/55 R 26.5	165 E	TL	380	Alliance	20.00	625	1345
15215680	600/55 R 26.5	165 D	TL	390	Alliance	20.00	624	1355
15216247	600/55 R 26.5	165 D	TL	882	Alliance	20.00	611	1333
15216248	600/55 R 26.5	165 D	TL	885	Alliance	20.00	625	1345
15215695	VF 600/55 R 26.5	167 D	TL	Agriflex 389 +	Alliance	20.00	629	1348
10000954	600/55 R 26.5	173 D	TL	590	Alliance	20.00	611	1333
15215692	600/55 R 26.5	177 D	TL	380 Industrial HD	Alliance	20.00	624	1350
15715212	600/55 R 26.5	176 A8/165 D	TL	FL 630 Ultra	BKT	20.00	611	1333
15715211	600/55 R 26.5	165 D	TL	Ridemax FL 693 M	BKT	20.00	611	1333
15715750	VF 600/55 R 26.5	167 D	TL	V-Flexa	BKT	20.00	615	1342
10001508	600/55 R 26.5	173 D	TL	FL 695	BKT	20.00	591	1335
15715208	600/55 R 26.5	177 D	TL	Ridemax FL 693 M	BKT	20.00	611	1333
15715209	600/55 R 26.5	177 D	TL	FL 630 Super	BKT	20.00	611	1333
13316300	VF 600/55 R 26.5	170 D	TL	TrailXBib	Michelin	20.00	624	1353
10915580	600/55 R 26.5	165 D	TL	Agriterra 02	Mitas	20.00	626	1335
10001037	600/55 R 26.5	165 D	TL	Twin Radial	Trelleborg	20.00	636	1341
15715760	VF 600/65 R 26.5	172 D	TL	V-Flexa	BKT	20.00	615	1453
15216170	620/55 R 26.5	166 D	TL	Flotmaster 381	Alliance	20.00	612	1356
14815210	620/55 R 26.5	166 D	TL	FLOTATION PRO	Vredestein	20.00	625	1360
17415620	620/60 R 26.5	169 D	TL	Country King	Nokian	20.00	625	1400
15215700	650/55 R 26.5	170 D/167 E	TL	380	Alliance	20.00	645	1360
15215653	650/55 R 26.5	170 D	TL	882	Alliance	20.00	645	1389
15215703	650/55 R 26.5	178 D	TL	380 Industrial HD	Alliance	20.00	641	1367
15215705	650/55 R 26.5	170 D	TL	390	Alliance	20.00	660	1395
10000955	650/55 R 26.5	177 D	TL	590	Alliance	20.00	650	1390
15215708	650/55 R 26.5	178 D	TL	390 Industrial HD	Alliance	20.00	663	1394
15216250	650/55 R 26.5	170 D	TL	885	Alliance	20.00	648	1380
15215710	VF 650/55 R 26.5	171 D	TL	Agriflex 389 +	Alliance	20.00	650	1384
15715216	650/55 R 26.5	169 D	TL	FL 630 Super	BKT	20.00	645	1389

Industrial HD = Industrial Heavy Duty (verstärkte Ausführung)

¹ = **empfohlene Felge** / weitere zulässige Felgenbreiten

Alles auf einen Blick:

statischer Halbmesser in mm	Abrollumfang in mm	Tragfähigkeit in kg	km/h	Luftdruck in bar
545	3695	5150	65	4,00
570	3780	5150	65	4,00
562	3843	5300	70	4,00
557	3843	7300/6700	65/70	5,00
555	3810	5600	65	4,00
707	4721	6700	65	4,00
688	4520	7100/6500	40/50	2,80
695	4745	7100/6500	40/50	2,80
609	4160	5150	70	4,00
618	4160	5150	70	5,00
613	4119	5150	65	4,00
604	4043	5150	65	4,00
610	3980	5150	65	4,00
587	4064	5450	65	2,80
612	4071	6500	65	6,00
606	4136	7300	65	5,00
579	4070	7100/5150	40/65	4,00
586	4051	5150	65	4,00
580	3986	5450	65	2,80
620	4090	7500	65	6,00
584	4077	7300	65	6,00
604	4104	7300	65	6,00
568	3960	6000	65	3,20
585	4033	5150	65	4,00
605	4110	5150	65	4,00
628	4377	6300	65	2,80
608	4147	5300	65	4,00
620	4200	5300	65	4,00
639	4291	5800	65	4,00
618	4175	6000/5450	65/70	4,00
621	4227	6000	65	4,00
614	4020	7500	65	5,00
629	4266	6000	65	4,00
635	4253	7300	65	6,00
635	4266	7500	65	5,00
630	4080	6000	65	4,00
600	4173	6150	65	2,80
627	4258	5800	65	4,00



Alliance 380 /
380 Industrial HD



Alliance
Flotmaster 381

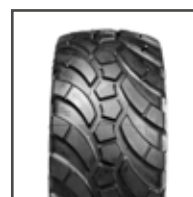

Alliance Agriflex 389+



Alliance 390 /
390 Industrial HD

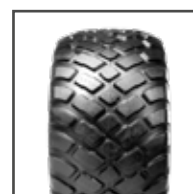

Alliance 882

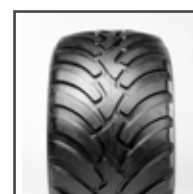

Alliance 885



Alliance 590

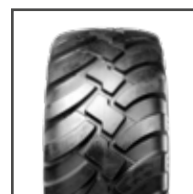

BKT FL 630 Super



BKT FL 630 Ultra



BKT FL 635

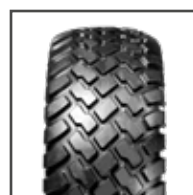

BKT Ridemax FL 690



BKT Ridemax
FL 693 M



BKT FL 695

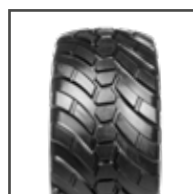

BKT V-Flexa



Michelin TrailXBib



Mitas Agriterra 02

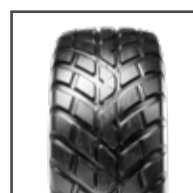

Nokian
Country King

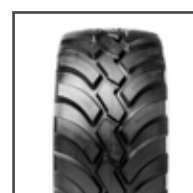

Trelleborg
Twin Radial



Vredestein
FLOTATION PRO



Vredestein
FLOTATION TRAC



Flotationreifen Radial





Preise und Bestände finden Sie unter www.bohnenkamp.de/shop

Artikel-Nr.	Größe	Last-/ Speed-Index	TL/ TT	Profil	Marke	Felge ¹	Breite in mm	Außen ø in mm
15715755	VF 650/55 R 26.5	171 D	TL	V-Flexa	BKT	20.00	644	1389
15715224	650/55 R 26.5	178 D	TL	FL 695	BKT	20.00/22.00	630	1390
15715214	650/55 R 26.5	178 D	TL	FL 630 Super	BKT	20.00	645	1389
15715218	650/55 R 26.5	180 A8/169 D	TL	FL 630 Ultra	BKT	20.00	645	1389
15715217	650/55 R 26.5	169 D	TL	Ridemax FL 693 M	BKT	20.00	645	1389
15715222	650/55 R 26.5	178 D	TL	Ridemax FL 693 M	BKT	20.00	645	1389
13316440	VF 650/55 R 26.5	174 D	TL	TrailXBib	Michelin	20.00	649	1402
10915590	650/55 R 26.5	169 D	TL	Agriterra 02	Mitas	20.00	653	1383
14816170	650/55 R 26.5	169 D	TL	FLOTATION TRAC	Vredestein	20.00	650	1400
17415700	650/55 R 26.5	177 D	TL	CT	Nokian	20.00/22.00	645	1389
15215740	650/60 R 26.5	173 D	TL	380	Alliance	20.00	660	1450
15215736	VF 650/60 R 26.5	174 D	TL	Agriflex 389 +	Alliance	20.00	665	1453
15215743	650/65 R 26.5	165 D	TL	388	Alliance	20.00	651	1500
15216252	650/65 R 26.5	174 D	TL	885	Alliance	20.00	645	1519
15715219	650/65 R 26.5	174 D	TL	FL 630 Super	BKT	20.00	645	1519
17415640	650/65 R 26.5	174 D	TL	Country King	Nokian	20.00	645	1518
17415642	650/65 R 26.5	174 D	TL	ELS	Nokian	20.00	650	1518
10001068	680/55 R 26.5	171 D	TL	Twin Radial	Trelleborg	20.00	685	1420
15215747	710/50 R 26.5	170 D	TL	380	Alliance	24.00	732	1400
15215745	710/50 R 26.5	172 D	TL	390	Alliance	24.00	730	1390
15215746	710/50 R 26.5	180 D	TL	390 Industrial HD	Alliance	24.00	734	1396
15216180	710/50 R 26.5	170 D	TL	Flotmaster 381	Alliance	24.00	710	1360
15216256	710/50 R 26.5	172 D	TL	882	Alliance	24.00	727	1383
15216255	710/50 R 26.5	170 D	TL	885	Alliance	24.00	732	1400
15215749	VF 710/50 R 26.5	173 D	TL	Agriflex 389 +	Alliance	24.00	732	1400
15715221	710/50 R 26.5	181 A8/170 D	TL	FL 630 Ultra	BKT	24.00/20.00	727	1383
15715223	710/50 R 26.5	170 D	TL	Ridemax FL 693 M	BKT	24.00/20.00	727	1383
10001163	710/50 R 26.5	179 D	TL	Ridemax FL 693 M	BKT	24.00/20.00	727	1383
13316450	VF 710/50 R 26.5	176 D	TL	TrailXBib	Michelin	24.00	739	1380
10915620	710/50 R 26.5	170 D	TL	Agriterra 02	Mitas	24.00/20.00	737	1388
17415600	710/50 R 26.5	170 D	TL	Country King	Nokian	24.00	740	1405
14815215	710/50 R 26.5	170 D	TL	FLOTATION PRO	Vredestein	24.00	710	1360
15216257	750/45 R 26.5	170 D	TL	885	Alliance	24.00	740	1360
15215754	750/45 R 26.5	173 D/170 E	TL	380	Alliance	24.00	750	1360
15215756	VF 750/45 R 26.5	172 D	TL	Agriflex 389 +	Alliance	24.00	754	1360
15715225	750/45 R 26.5	170 D	TL	FL 630 Super	BKT	24.00	754	1349
14816150	750/45 R 26.5	170 D	TL	FLOTATION TRAC	Vredestein	24.00	740	1365
17415776	750/55 R 26.5	177 D	TL	ELS	Nokian	24.00	750	1495
15715226	750/60 R 26.5	180 D	TL	FL 630 Super	BKT	24.00	754	1574
15216190	800/45 R 26.5	174 D	TL	Flotmaster 381	Alliance	28.00	801	1374

Industrial HD = Industrial Heavy Duty (verstärkte Ausführung)

¹ = empfohlene Felge / weitere zulässige Felgenbreiten

Alles auf einen Blick:

 statischer Halbmesser in mm	 Abrollumfang in mm	 Tragfähigkeit in kg	 km/h	 Luftdruck in bar
591	4100	6150	65	2,80
630	4242	7500	65	6,00
628	4292	7500	65	6,00
600	4207	8000/5800	40/65	4,00
608	4216	5800	65	4,00
609	4250	7500	65	6,00
575	4082	6700	65	3,20
627	4142	5800	65	4,00
635	4300	5800	65	4,00
639	4247	7300	65	6,00
655	4280	6500	65	4,00
622	4390	6700	65	2,80
661	4509	5150	65	2,80
670	4580	6700	65	4,00
684	4653	6700	65	4,00
689	4656	6700	65	4,00
680	4618	6700	65	4,00
631	4335	6150	65	4,00
630	4290	6000	65	4,00
627	4100	6300	65	4,00
625	4249	8000	65	5,00
610	4171	6000	65	4,00
623	4219	6300	65	4,00
629	4290	6000	65	4,00
602	4271	6500	65	2,80
599	4208	8250/6000	40/65	4,00
606	4217	6000	65	4,00
606	4217	7750	65	6,00
568	4022	7100	65	3,20
628	4189	6000	65	4,00
646	4304	6000	65	4,00
620	4200	6000	65	4,00
618	4138	6000	65	4,00
608	4165	6500/6000	65/70	5,00
589	4086	6300	65	2,80
606	4147	6000	65	4,00
620	4180	6000	65	4,00
670	4524	7300	65	4,00
694	4800	8000	65	4,00
613	4252	6700	65	4,00



Alliance 380

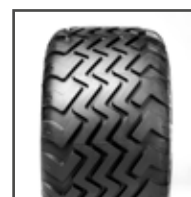

Alliance Flotmaster 381



Alliance 388



Alliance Agriflex 389+



Alliance 390 / 390 Industrial HD

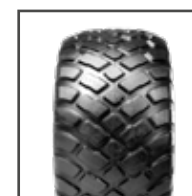

Alliance 882

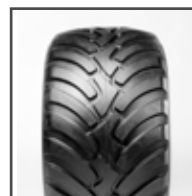

Alliance 885



BKT FL 630 Super



BKT FL 630 Ultra



BKT Ridemax FL 693 M



BKT FL 695

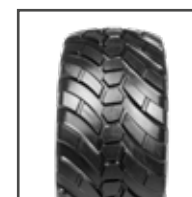

BKT V-Flexa



Michelin TrailXBib



Mitas Agriterra 02



Nokian CT



Nokian Country King



Nokian ELS

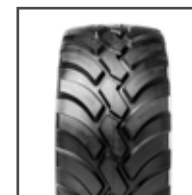

Trelleborg Twin Radial

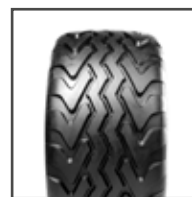

Vredestein FLOTATION PRO



Vredestein FLOTATION TRAC



Flotationreifen Radial



Preise und Bestände finden Sie unter www.bohnenkamp.de/shop

Artikel-Nr.	Größe	Last-/ Speed-Index	TL/ TT	Profil	Marke	Felge ¹	Breite in mm	Außen ø in mm
15216258	800/45 R 26.5	174 D	TL	885	Alliance	28.00 /24.00	800	1390
15215760	800/45 R 26.5	177 D	TL	390	Alliance	28.00	810	1395
15715231	800/45 R 26.5	184 A8/174 D	TL	FL 630 Ultra	BKT	28.00 /24.00	828	1393
10915630	800/45 R 26.5	174 D	TL	Agriterra 02	Mitas	24.00 /28.00	770	1394
17415643	800/45 R 26.5	174 D	TL	Country King	Nokian	28.00 /24.00	815	1396
14815220	800/45 R 26.5	174 D	TL	FLOTATION PRO	Vredestein	28.00	800	1370
14816190	800/45 R 26.5	174 D	TL	FLOTATION TRAC	Vredestein	28.00	800	1380
15715228	850/40 R 26.5	184 A8/173 D	TL	FL 639	BKT	28.00	860	1355
15215790	600/60 R 30.5	173 D	TL	390	Alliance	20.00 /20	600	1506
10000956	600/60 R 30.5	173 D	TL	590	Alliance	20.00	611	1495
15715233	600/60 R 30.5	173 D	TL	Ridemax FL 693 M	BKT	20.00 /18.00	605	1495
13315300	600/60 R 30.5	169 D	TL	CargoXBib	Michelin	20.00	639	1496
10915650	600/60 R 30.5	173 D	TL	Agriterra 04	Mitas	20.00	625	1500
17415920	600/60 R 30.5	173 D	TL	CT	Nokian	20.00	610	1496
15215793	650/65 R 30.5	176 D	TL	380	Alliance	20.00	680	1625
15715235	650/65 R 30.5	176 D	TL	FL 630 Super	BKT	20.00	645	1621
13316500	VF 650/65 R 30.5	176 D	TL	TrailXBib	Michelin	24.00	668	1624
17415670	650/65 R 30.5	176 D	TL	Country King	Nokian	20.00	660	1623
10001035	650/65 R 30.5	176 D	TL	Twin Radial	Trelleborg	20.00	675	1635
10915660	680/60 R 30.5	176 D	TL	Agriterra 03	Mitas	20.00	697	1623
15215795	710/50 R 30.5	176 D	TL	390	Alliance	24.00	727	1495
10000141	710/50 R 30.5	176 D	TL	Flotation 331 Radial	Alliance	24.00	700	1500
15216264	710/50 R 30.5	173 D	TL	885	Alliance	24.00	733	1490
15715240	710/50 R 30.5	173 D	TL	Ridemax FL 693 M	BKT	24.00 /20.00	727	1485
13315320	710/50 R 30.5	173 D	TL	CargoXBib	Michelin	24.00	728	1495
15215805	750/60 R 30.5	181 D	TL	380	Alliance	24.00	767	1680
15215800	750/60 R 30.5	181 D	TL	390	Alliance	24.00	780	1675
15215801	750/60 R 30.5	190 D	TL	390 Industrial HD	Alliance	24.00	770	1685
15216265	750/60 R 30.5	181 D	TL	885	Alliance	24.00	767	1680
15216267	750/60 R 30.5	181 D	TL	882	Alliance	24.00	754	1675
15215806	VF 750/60 R 30.5	183 D	TL	Agriflex 389 +	Alliance	24.00	780	1680
15715245	750/60 R 30.5	181 D	TL	FL 630 Super	BKT	24.00	754	1675
15715250	750/60 R 30.5	181 D	TL	Ridemax FL 693 M	BKT	24.00	754	1675
10001260	VF 750/60 R 30.5	187 D	TL	V-Flexa	BKT	24.00	780	1675
13316530	VF 750/60 R 30.5	187 D	TL	TrailXBib	Michelin	24.00	782	1678
10915670	750/60 R 30.5	181 D	TL	Agriterra 03	Mitas	24.00	792	1672
17415675	750/60 R 30.5	181 D	TL	Country King	Nokian	24.00	750	1680
10001067	750/60 R 30.5	181 D	TL	Twin Radial	Trelleborg	24.00	790	1678
15215808	800/45 R 30.5	176 D	TL	885	Alliance	28.00 /24.00	790	1495

HD = Heavy Duty (verstärkte Ausführung)

¹ = **empfohlene Felge** / weitere zulässige Felgenbreiten

Alles auf einen Blick:

 statischer Halbmesser in mm	 Abrollumfang in mm	 Tragfähigkeit in kg	 km/h	 Luftdruck in bar
623	4216	6700	65	4,00
627	4110	7300	65	4,00
618	4238	9000/6700	40/65	4,00
628	4163	6700	65	4,00
622	4240	6700	65	4,00
625	4200	6700	65	4,00
640	4300	6700	65	4,00
599	4122	9000/6500	40/65	4,00
693	4587	6500	65	4,00
684	4542	6500	65	5,00
681	4495	6500	65	5,00
654	4417	5800	65	4,00
690	4524	6500	65	5,00
681	4570	6500	65	5,00
726	4881	7100	65	4,00
734	4976	7100	65	4,00
699	4778	7100	65	3,20
737	4969	7100	65	4,00
735	4975	7100	65	4,00
740	4875	7100	65	4,00
680	4430	7100	65	4,00
674	4570	7100	65	4,00
677	4560	6500	65	4,00
656	4533	6500	65	4,00
649	4408	6500	65	4,00
754	5145	8250	65	4,00
756	4950	8250	65	4,00
751	5136	10600	65	5,00
754	5113	8250	65	4,00
748	5121	8250	65	4,00
721	5071	8750	65	2,80
746	5115	8250	65	4,00
728	5092	8250	65	4,00
728	5085	9750	65	3,20
695	4873	9750	65	3,20
755	4998	8250	65	4,00
757	5144	8250	65	4,00
756	5130	8250	65	4,00
670	4597	7100	65	4,00



Alliance Flotation 331 Radial



Alliance 380

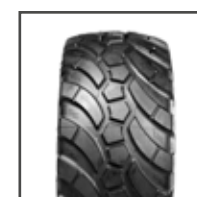

Alliance Agriflex 389+



Alliance 390 / 390 Industrial HD



Alliance 590

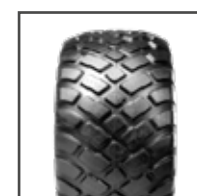

Alliance 882

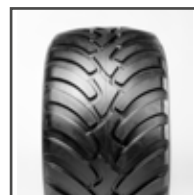

Alliance 885



BKT FL 630 Super



BKT FL 630 Ultra



BKT FL 639



BKT Ridemax FL 693 M

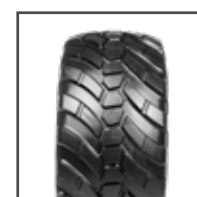

BKT V-Flexa



Michelin CargoXBib



Michelin TrailXBib



Mitas Agriterra 02



Mitas Agriterra 03



Mitas Agriterra 04

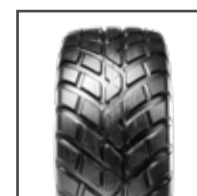

Nokian Country King



Trelleborg Twin Radial

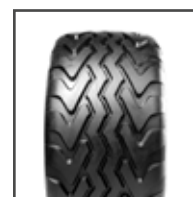

Vredestein FLOTATION PRO



Vredestein FLOTATION TRAC







Flotationreifen Radial

Preise und Bestände finden Sie unter www.bohnenkamp.de/shop

Artikel-Nr.	Größe	Last- / Speed-Index	TL/TT	Profil	Marke	Felge ¹	Breite in mm	Außen ø in mm
15215810	850/50 R 30.5	182 D	TL	390	Alliance	28.00	882	1653
15715260	850/50 R 30.5	182 D	TL	Ridemax FL 693 M	BKT	28.00	862	1625
13315350	850/50 R 30.5	182 D	TL	CargoXBib	Michelin	28.00	861	1628
10915680	850/50 R 30.5	182 D	TL	Agriterra 02	Mitas	28.00	880	1620
13615350	850/50 R 30.5	182 D	TL	Twin Radial	Trelleborg	28.00	875	1630
15215830	30.5L R 32	181 B	TL	390	Alliance	27	790	1800
15715280	30.5L R 32	181 B	TL	Ridemax FL 690	BKT	27	790	1800
15215820	800/60 R 32	184 D/181 E	TL	390	Alliance	27	800	1800
15715269	800/60 R 32	185 D	TL	Ridemax FL 690	BKT	27	800	1800
15215819	VF 800/60 R 32	188 D	TL	Agriflex 389 +	Alliance	27	800	1800
10000351	800/65 R 32	185 D	TL	Ridemax FL 615	BKT	27	830	1853
10915690	800/65 R 32	185 D	TL	Agriterra 04	Mitas	25/23/27/28	785	1859
15215836	35.5L R 32	193 A8/190 D	TL	393	Alliance	31/30	925	1986
15215870	710/55 R 34	169 D	TL	388	Alliance	24	712	1656
17415800	710/55 R 34	177 D	TL	ELS	Nokian	24/20/23	707	1641
15215880	800/50 R 34	168 D	TL	388	Alliance	25/23/28	800	1659
17415810	800/50 R 34	181 D	TL	ELS	Nokian	25/23/24/28	800	1650
17415812	800/60 R 34	186 D	TL	ELS	Nokian	25/24/28	800	1812

¹ = empfohlene Felge / weitere zulässige Felgenbreiten

Alles auf einen Blick:

 statischer Halbmesser in mm	 Abrollumfang in mm	 Tragfähigkeit in kg	 km/h	 Luftdruck in bar
742	4860	8500	65	4,00
719	4925	8500	65	4,00
692	4778	8500	65	4,00
732	4844	8500	65	4,00
735	4946	8500	65	4,00
805	5431	8250	50	3,00
806	5430	8250	50	3,00
806	5424	9000/8250	65/70	4,00
817	5454	9250	65	4,00
778	5465	10000	65	2,80
834	5624	9250	65	3,60
835	5442	9250	65	3,60
864	5952	11500/10600	40/65	3,00
720	4910	5800	65	2,80
748	4995	7300	65	4,00
746	5088	5600	65	2,40
801	5089	8250	65	4,00
813	5542	9500	65	4,00



Flotationreifen



Straßenwalzenreifen





Preise und Bestände finden Sie unter www.bohnenkamp.de/shop

Artikel-Nr.	Größe	Last-/ Speed-Index	PR	TL/ TT	Profil	Marke	Felge ¹	Breite in mm	Außen ø in mm
15222206	14.9 - 24	123 A8	6 PR	TL	329	Alliance	13/12	394	1241
15722185	14.9 - 24	128 A6/124 A8	8 PR	TL	TR 391	BKT	13	405	1270
15222262	16.9 - 24	133 A8	8 PR	TL	329	Alliance	15	442	1309
15772442	18.4 - 26	146 A6	12 PR	TL	TR 387	BKT	16/15	475	1430
15222357	23.1 - 26	168 A8	16 PR	TL	330	Alliance	20	587	1560
15222360	23.1 - 26	153 A8	12 PR	TL	329	Alliance	20	587	1560
15222365	23.1 - 26	159 A8	16 PR	TL	329	Alliance	20	587	1560
15772441	23.1 - 26	145 A6	8 PR	TL	TR 387	BKT	20	592	1560
15772440	23.1 - 26	162 A8	12 PR	TL	TR 387	BKT	20	592	1560
15222391	28L - 26	173 A8	16 PR	TL	330	Alliance	25	714	1590
15722336	12.4 - 28	123 A6	8 PR	TL	TR 387	BKT	11/9/10	325	1200
15222450	13.6 - 28	121 A8	6 PR	TL	329	Alliance	12/11	345	1311
15722437	16.9 - 28	135 A6	8 PR	TL	TR 387	BKT	15/14	440	1400
15722465	16.9 - 30	137 A6	8 PR	TL	TR 387	BKT	15/14	440	1450
15722475	18.4 - 30	139 A6	8 PR	TL	TR 387	BKT	16	475	1530

¹ = **empfohlene Felge** / weitere zulässige Felgenbreiten



Alles auf einen Blick:

 statischer Halbmesser in mm	 Abrollumfang in mm	 Tragfähigkeit in kg	 km/h	 Luftdruck in bar
569	3698	1550	40	1,40
574	3805	1800/1600	30/40	1,80
579	3814	2060	40	1,70
635	4150	3000	30	2,30
690	4545	5600	40	2,30
690	4545	3650	40	1,70
690	4545	4375	40	2,30
690	4688	2900	30	1,10
690	4688	5000	30	1,70
702	4627	6500	40	2,20
550	3576	1550	30	2,30
610	3942	1450	40	1,60
630	4074	2180	30	1,70
655	4220	2300	30	1,70
680	4395	2430	30	1,40



Alliance 329



Alliance 330



BKT TR 387











BKT TR 391





Industrie Traktorreifen

Preise und Bestände finden Sie unter www.bohnenkamp.de/shop

									
Artikel-Nr.	Größe	Last-/ Speed-Index	PR	TL/ TT	Profil	Marke	Felge ¹	Breite in mm	Außen ø in mm
15222212	14.9 - 24	145 A8	12 PR	TL	533	Alliance	13/12	378	1241
15772538	14.9 - 24	145 A8	12 PR	TT	AT 625	BKT	13/11/12	400	1265
15772555	14.9 - 24	145 A8	12 PR	TL	TR 459	BKT	13/11/12	390	1244
15222273	15.5/80 - 24	157 A6/154 A8	12 PR	TT	533	Alliance	12/13/14	394	1262
15712494	15.5/80 - 24	151 A6	16 PR	TL	Grip Star	BKT	12/13/14	392	1270
15222264	16.9 - 24	149 A8	12 PR	TL	533	Alliance	15	429	1309
15772560	16.9 - 24	149 A8	12 PR	TL	TR 459	BKT	15/14	440	1310
15772562	16.9 - 24	149 A8	12 PR	TL	TR 463	BKT	15/14	445	1300
15772568	16.9 - 24	149 A8	12 PR	TL	AT 621	BKT	15/14	450	1302
15772570	17.5L - 24	148 A6	12 PR	TL	TR 459	BKT	15/14	445	1270
15772575	18.4 - 24	155 A8	12 PR	TL	TR 459	BKT	16/15	472	1375
15772580	19.5L - 24	151 A8	12 PR	TL	TR 459	BKT	16	490	1333
15772585	19.5L - 24	151 A8	12 PR	TL	AT 621	BKT	16	482	1305
15772590	21 L - 24	155 A8	12 PR	TL	TR 459	BKT	18	533	1378
15772445	18.4 - 26	156 A8	12 PR	TL	TR 459	BKT	16/15	472	1425
15772595	18.4 - 26	156 A8	12 PR	TL	AT 621	BKT	16/15	480	1425
15722440	16.9 - 28	152 A8	12 PR	TL	TR 459	BKT	15/14	440	1410
15772539	16.9 - 28	152 A8	12 PR	TT	AT 625	BKT	15/14	450	1415
15772588	16.9 - 28	152 A8	12 PR	TL	TR 463	BKT	15/14	450	1405
15772593	16.9 - 30	153 A8	12 PR	TL	TR 459	BKT	15/14	440	1470
15772597	16.9 - 30	153 A8	12 PR	TL	AT 621	BKT	15/14	450	1460

¹ = empfohlene Felge / weitere zulässige Felgenbreiten

Alles auf einen Blick:

statischer Halbmesser in mm	Abrollumfang in mm	Tragfähigkeit in kg	km/h	Luftdruck in bar
560	3661	2900	40	2,90
575	3800	2900	40	2,90
562	3657	2900	40	2,90
552	3652	4125/3750	30/40	3,00
569	3683	3450	30	5,20
589	3855	3250	40	2,50
590	3850	3250	40	2,60
584	3877	3250	40	2,60
590	3906	3250	40	2,60
557	3825	3150	30	2,70
610	4114	3875	40	2,50
585	4031	3450	40	2,30
587	3936	3450	40	2,30
605	3995	3875	40	2,20
628	4346	4000	40	2,50
649	4288	4000	40	2,50
640	4145	3550	40	2,60
645	4254	3550	40	2,60
636	4190	3550	40	2,60
657	4484	3650	40	2,60
670	4398	3650	40	2,60



Alliance 533



BKT AT 621



BKT AT 625



BKT Grip Star



BKT TR 459

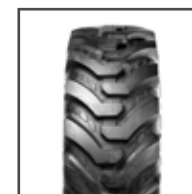

BKT TR 463

202

Implementräder

210

Anhängerräder runderneuert

210

**Anhängerräder Windpower
und Sailun**

214

Flotationräder Diagonal

222

Flotationräder Radial

242

**Flotationräder mit Anschluss
für Reifendruckregelanlage**

244

Flotationräder für Agrotucks



**IMPLEMENT-/
FLOTATIONRÄDER**



Implement-/
Flotationräder

SERVICE-PLUS BY BOHNENKAMP

Erhalten Sie direkten Zugriff
auf unseren Online-Shop











Implementräder

Preise und Bestände finden Sie unter www.bohnenkamp.de/shop

Artikel-Nr.	Größe	Last-/ Speed-Index Reifen	PR	Profil	Marke	Felge	Anschluss	Bolzenloch- ausführung	Einpresse- tiefe	Breite in mm
59911141	7.00 - 12	95 A8	6 PR	AS 504	BKT	4.5 J x 12	5/110/160	E1	0	187
59991502	31x15.50 - 15	118 A8 / 116 B	8 PR	Grassland Flot.221	Alliance	13 LB x 15	6/161/205	A2	0	391
59991517	31x15.50 R 15	122 B		AS 511	BKT	13 LB x 15	6/161/205	A2	-55	388
59991516						13 LB x 15	6/161/205	B2	0	388
10000868	400/50 - 15	121 A8	8 PR	AS 504	BKT	13 LB x 15 H2	6/161/205	E2	-85	395
59910548	27x10 - 15.3	107 A8	8 PR	AS 504	BKT	9.00 x 15.3	5/66.5/112	A1	0	260
59910547							9.00 x 15.3	6/161/205	E2	+20
59911660	10.0/75 - 15.3	123 A8	10 PR	AS 504	BKT	9.00 x 15.3	6/161/205	B2	-40	264
59911650							9.00 x 15.3	6/161/205	E2	-5
59911296	10.0/75 - 15.3	135 A8	18 PR	AS 504	BKT	9.00 x 15.3	6/161/205	A2	0	264
59911413	10.0/75 - 15.3	123 A8	10 PR	AW 702	BKT	9.00 x 15.3	6/161/205	B2	-40	274
59911412							9.00 x 15.3	6/161/205	E2	-5
59911461	10.0/75 - 15.3	130 A8	14 PR	AW 702	BKT	9.00 x 15.3	6/161/205	B2	-40	274
59911460							9.00 x 15.3	6/161/205	E2	-5
59911283	10.0/75 - 15.3	135 A8	18 PR	AW 702	BKT	9.00 x 15.3	6/161/205	B2	-40	274
59911281							9.00 x 15.3	6/161/205	E2	-5
59911298	10.0/75 - 15.3	137 A8	22 PR	AW 702	BKT	9.00 x 15.3	6/161/205	B2	-40	274
59911294							9.00 x 15.3	6/161/205	A2	-5
59696578	260/75 - 15.3	123 A8	10 PR	SG-816	Deli	9.00 x 15.3	6/161/205	B2	-40	268
59696577							9.00 x 15.3	6/161/205	E2	-5
59911675	11.5/80 - 15.3	145 A6 / 141 A8	14 PR	320 Value Plus	Alliance	9.00 x 15.3	6/161/205	E2	-5	290
59911554	11.5/80 - 15.3	126 A8	8 PR	AS 504	BKT	9.00 x 15.3	6/161/205	B2	-40	290
59911553							9.00 x 15.3	6/161/205	E2	-5
59911483	11.5/80 - 15.3	131 A8	10 PR	AW 702	BKT	9.00 x 15.3	6/161/205	B2	-40	297
59911482							9.00 x 15.3	6/161/205	E2	-5
59911571	11.5/80 - 15.3	135 A8	12 PR	AS 504	BKT	9.00 x 15.3	6/161/205	B2	-40	290
59911574							9.00 x 15.3	6/161/205	E2	+20
59911488	11.5/80 - 15.3	139 A8	14 PR	AW 702	BKT	9.00 x 15.3	6/161/205	A2	-5	297
59911489							9.00 x 15.3	6/161/205	B2	-40
59911288	11.5/80 - 15.3	143 A8	18 PR	AW 702	BKT	9.00 x 15.3	6/161/205	B2	-40	297
59911286							9.00 x 15.3	6/161/205	A2	-5
59911476	12.5/80 - 15.3	142 A8	14 PR	AW 702	BKT	9.00 x 15.3	6/161/205	B2	-40	312
59911475							9.00 x 15.3	6/161/205	A2	-5
59911681	400/60 - 15.5	145 A8	14 PR	FarmPRO 327	Alliance	13.00 x 15.5	6/161/205	E2	0	405
59911746	400/60 - 15.5	145 A8	14 PR	AW 708	BKT	13.00 x 15.5	6/161/205	E2	0	405
59911754	400/60 - 15.5	145 A8	14 PR	TR 882	BKT	13.00 x 15.5	6/161/205	E2	0	400

Alle Räder in TL Ausführung Standardlackierung für alle Felgen ist silber

Alles auf einen Blick:

					
Außen ϕ in mm	stat. Halbmesser in mm	Abrollumfang in mm	Tragfähigkeit kpl. Rad in kg	km/h	Luftdruck in bar
683	300	2.001	690	40	3,40
792	353	2.319	1320/1250	40/50	3,10
785	353	2.387	1500	40	2,80
785	353	2.387	1500	40	2,80
790	369	2.387	1400	40	3,00
695	317	2.071	975	40	3,10
695	317	2.071	975	40	3,10
785	360	2.404	1550	40	3,90
785	360	2.404	1550	40	3,90
785	360	2.404	2180	40	7,10
760	343	2.227	1550	40	3,90
760	343	2.227	1550	40	3,90
760	343	2.227	1900	40	5,50
760	343	2.227	1900	40	5,50
760	343	2.227	2180	40	7,10
760	343	2.227	2180	40	7,10
760	343	2.227	2300	40	7,10
760	343	2.227	2300	40	7,10
778	346	2.317	1550	40	3,90
778	346	2.317	1550	40	3,90
845	372	2.456	2900/2575	30/40	6,50
867	380	2.540	1700	40	2,70
867	380	2.540	1700	40	2,70
844	370	2.473	1950	40	3,40
844	370	2.473	1950	40	3,40
867	380	2.540	2180	40	4,10
867	380	2.540	2180	40	4,10
844	370	2.473	2430	40	4,75
844	370	2.473	2430	40	4,75
844	370	2.473	2700	40	6,10
844	370	2.473	2725	40	6,10
885	387	2.593	2650	40	4,30
885	387	2.593	2650	40	4,30
874	375	2.498	2900	40	3,60
875	380	2.564	2900	40	4,90
875	378	2.605	2900	40	3,60

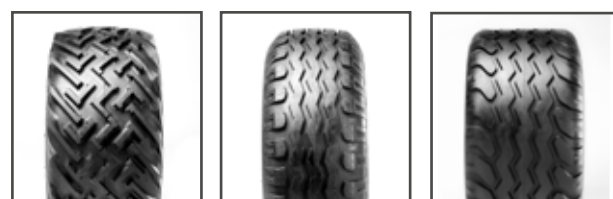

Alliance Grassland
Flotation 221

Alliance 320
Value Plus

Alliance
FarmPRO 327

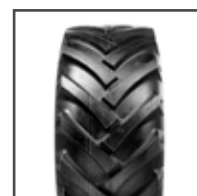

BKT AS 504



BKT AS 511



BKT AW 702



BKT AW 708

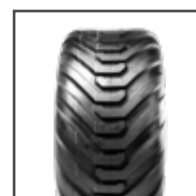

BKT TR 882



Deli SG-816

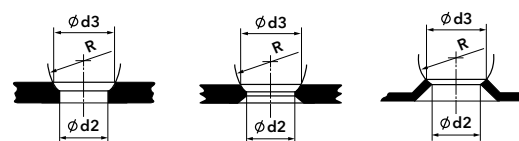

A1/A2

B2

E1/E2

Maße für Kugelansenkung

Bezeichnung	d2	d3	R	Bolzen- gewinde
A1	18,5	24	14	M14x1,5
A2	21,5	27	16	M18x1,5
B2	21,5	27	16	M18x1,5
E1	18,5	24	14	M14x1,5
E2	21,5	27	16	M18x1,5



Implementräder

Preise und Bestände finden Sie unter www.bohnenkamp.de/shop

Artikel-Nr.	Größe	Last-/ Speed-Index Reifen	PR	Profil	Marke	Felge	Anschluss	Bolzenloch- ausführung	Einpress- tiefe	Breite in mm
59912749	400/60 - 15.5	149 A8	18 PR	AW 708	BKT	13.00 x 15.5	6/161/205	E2	0	405
59911695	400/60 - 15.5	149 A8	18 PR	TR 882	BKT	13.00 x 15.5	6/161/205	E2	0	400
59911993	340/55 - 16	133 A8		AW 729	BKT	11 x 16	6/161/205	A2	0	343
59911984	13.0/55 - 16	133 A8	14 PR	AW 702	BKT	11 x 16	6/161/205	A2	0	336
59911970	13.0/75 - 16	135 A8	10 PR	AW 702	BKT	11 x 16	6/161/205	A2	0	340
10001267	14.0/65 - 16	142 A8	14 PR	AW 705	BKT	11 x 16	6/161/205	A2	0	353
59911710	15.0/55 - 17	141 A6 / 138 A8	14 PR	320 Value Plus	Alliance	13.00 x 17	6/161/205	A2	0	391
59911712						13.00 x 17	8/221/275	A2	0	391
59911713						13.00 x 17	8/221/275	A3	0	391
10000869	15.0/55 - 17	134 A8	10 PR	AS 504	BKT	13.00 x 17	6/161/205	E2	-85	380
10000887						13.00 x 17	6/161/205	E2	-40	380
59912100						13.00 x 17	6/161/205	A2	0	380
10000905						13.00 x 17	6/161/205	B2	+45	380
59912160						13.00 x 17	6/161/205	A2	0	381
59912199	15.0/55 - 17	134 A8	10 PR	AW 729	BKT	13.00 x 17	6/161/205	A2	0	385
59912201						13.00 x 17	8/221/275	A2	0	385
59912404	15.0/55 - 17	141 A8	14 PR	AS 504	BKT	13.00 x 17	6/161/205	A2	0	380
59912182	15.0/55 - 17	141 A8	14 PR	AW 705	BKT	13.00 x 17	6/161/205	A2	0	381
59912167						13.00 x 17	8/221/275	A2	0	381
59912193						13.00 x 17	8/221/275	A3	0	381
59912177	15.0/55 - 17	146 A8	18 PR	AW 705	BKT	13.00 x 17	8/221/275	A2	0	381
59913215	420/55 - 17	133 A8		AW 726	BKT	13.00 x 17	6/161/205	A2	0	415
59913092	420/55 - 17	145 A8	16 PR	AS 504	BKT	13.00 x 17	6/161/205	A2	0	430
10000903	425/55 R 17	140 A8 / 129 D		Ridemax FL 693 M	BKT	13.00 x 17	6/161/205	0	-40	420
59912070						13.00 x 17	6/161/205	A2	0	420
59912072						13.00 x 17	8/221/275	A3	0	420
10000933						13.00 x 17	6/161/205	B2	+45	420
59912079						13.00 x 17	8/221/275	A3	+50	420
59912284	19.0/45 - 17	138 A8	10 PR	AW 708	BKT	16.00 x 17	6/161/205	A2	-35	491
59912206						16.00 x 17	6/161/205	A2	0	491
59912364	19.0/45 - 17	144 A8	14 PR	AS 504	BKT	16.00 x 17	6/161/205	A2	-35	465
59912358						16.00 x 17	6/161/205	A2	0	465
59912316	19.0/45 - 17	144 A8	14 PR	AW 708	BKT	16.00 x 17	6/161/205	A2	-35	491
59912296						16.00 x 17	6/161/205	A2	0	491
59912252						16.00 x 17	8/221/275	A2	0	491
59912245						16.00 x 17	8/221/275	A3	0	491

Alle Räder in TL Ausführung Standardlackierung für alle Felgen ist silber

Alles auf einen Blick:

Außen ϕ in mm	stat. Halbmesser in mm	Abrollumfang in mm	Tragfähigkeit kpl. Rad in kg	km/h	Luftdruck in bar
875	380	2.564	3250	40	4,50
875	378	2.605	3250	40	4,50
785	358	2.358	2060	40	3,20
770	345	2.256	2060	40	4,20
890	396	2.726	2180	40	3,00
870	388	2549	2650	40	4,00
850	372	2.490	2575/2360	30/40	3,70
850	372	2.490	2575/2360	30/40	3,70
850	372	2.490	2575/2360	30/40	3,70
890	395	2.608	2120	40	2,60
890	395	2.608	2575	40	3,70
890	395	2.608	2120	40	2,60
890	395	2.608	2120	40	2,60
850	391	2.575	2120	40	2,60
850	377	2.560	2120	40	2,60
850	377	2.560	2120	40	2,60
890	395	2.608	2575	40	3,70
850	391	2.575	2575	40	3,70
850	391	2.575	2575	40	3,70
850	391	2.575	2575	40	3,70
850	391	2.575	3000	40	4,70
890	392	2.584	2060	40	2,00
910	407	2.712	2900	40	3,50
894	397	2.704	2500/1850	40/65	4,00
894	397	2.704	2500/1850	40/65	4,00
894	397	2.704	2500	40	4,00
894	397	2.704	2500/1850	40/65	4,00
894	397	2.704	2500	40	4,00
866	380	2.536	2360	40	3,00
866	380	2.536	2360	40	3,00
865	389	2.578	2800	40	2,80
865	389	2.578	2800	40	2,80
866	380	2.536	2800	40	3,90
866	380	2.536	2800	40	3,90
866	380	2.536	2800	40	3,90
866	380	2.536	2800	40	3,90



A2/A3 **B2** **E2**

Maße für Kugelansenkung

Bezeichnung	d2	d3	R	Bolzen- gewinde
A2	21,5	27	16	M18x1,5
A3	27	32	18	M22x1,5/M20x1,5
B2	21,5	27	16	M18x1,5
E2	21,5	27	16	M18x1,5

Implement-/
Flotationräder



Implementräder

Preise und Bestände finden Sie unter www.bohnenkamp.de/shop

Artikel-Nr.	Größe	Last-/ Speed-Index Reifen	PR	Profil	Marke	Felge	Anschluss	Bolzenloch- ausführung	Einpress- tiefe	Breite in mm
59912379	19.0/45 - 17	147 A8	16 PR	AS 504	BKT	16.00 x 17	6/161/205	A2	-35	465
59912378						16.00 x 17	6/161/205	A2	0	465
59912318	19.0/45 - 17	148 A8	18 PR	AW 708	BKT	16.00 x 17	6/161/205	A2	-35	491
59912328						16.00 x 17	6/161/205	A2	0	491
59911687	480/45 - 17	146 A8	14 PR	FarmPRO 327	Alliance	16.00 x 17	6/161/205	A2	-70	480
59912340						16.00 x 17	6/161/205	A2	-35	480
59911686						16.00 x 17	6/161/205	A2	0	480
59911707	480/45 - 17	149 A8	18 PR	FarmPRO 327	Alliance	16.00 x 17	6/161/205	A2	-35	480
59911703						16.00 x 17	6/161/205	A2	0	480
59912336	VF 480/45 R 17	167 A8		AW 711	BKT	16.00 x 17	6/161/205	A2	-35	491
59912335						16.00 x 17	6/161/205	A2	0	491
59911722	500/50 - 17	153 A6 / 149 A8	14 PR	320 Value Plus	Alliance	16.00 x 17	6/161/205	A2	-35	500
59911721						16.00 x 17	6/161/205	A2	0	500
59911724						16.00 x 17	8/221/275	A3	0	500
59911691	500/50 - 17	149 A8	14 PR	FarmPRO 327	Alliance	16.00 x 17	6/161/205	A2	-35	500
59911690						16.00 x 17	6/161/205	A2	0	500
59911719	500/50 - 17	154 A8	18 PR	FarmPRO 327	Alliance	16.00 x 17	6/161/205	A2	-35	500
59911718						16.00 x 17	6/161/205	A2	0	500
59912310	500/50 - 17	140 A8	10 PR	AW 708	BKT	16.00 x 17	6/161/205	A2	-35	500
59912305						16.00 x 17	6/161/205	A2	0	500
59912230	500/50 - 17	149 A8	14 PR	AW 708	BKT	16.00 x 17	6/161/205	A2	-35	500
59912300						16.00 x 17	6/161/205	A2	0	500
59912234						16.00 x 17	8/221/275	A2	0	500
59912402	520/50 R 17	151 D / 148 E		FL 637	BKT	16.00 x 17	6/161/205	A2	-35	516
59912400						16.00 x 17	6/161/205	A2	0	516
59912401						16.00 x 17	8/221/275	A2	0	516
59911205	10.5/80 - 18	135 A6 / 131 A8	10 PR	320 Value Plus	Alliance	9 x 18	6/161/205	A2	0	274
59911206						9 x 18	8/221/275	A2	0	274
59912398	10.5/80 - 18	131 A8	10 PR	AS 504	BKT	9 x 18	8/221/275	B3	0	274
59912395	10.5/80 - 18	131 A8	10 PR	AW 702	BKT	9 x 18	6/161/205	A2	0	275
59912397						9 x 18	8/221/275	A2	0	275
59911292	10.5/80 - 18	138 A8	14 PR	AW 702	BKT	9 x 18	6/161/205	A2	0	275
59911293						9 x 18	8/221/275	A2	0	275
59911208	12.5/80 - 18	152 A6 / 148 A8	16 PR	320 Value Plus	Alliance	11 x 18	6/161/205	B2	-35	308
59911207						11 x 18	6/161/205	A2	0	308
59911209						11 x 18	8/221/275	A2	0	308

Alle Räder in TL Ausführung Standardlackierung für alle Felgen ist silber

Alles auf einen Blick:

Außen ϕ in mm	stat. Halbmesser in mm	Abrollumfang in mm	Tragfähigkeit kpl. Rad in kg	km/h	Luftdruck in bar
865	389	2.578	3075	40	3,10
865	389	2.578	3075	40	3,10
866	380	2.536	3150	40	3,30
866	380	2.536	3150	40	3,30
865	400	2.592	3000	40	2,80
865	400	2.592	3000	40	2,80
865	400	2.592	3000	40	2,80
865	400	2.592	3250	40	3,30
865	400	2.592	3250	40	3,30
866	363	2.644	4420	40	5,00
866	363	2.644	4420	40	5,00
932	424	2.760	3650/3250	30/40	2,80
932	424	2.760	3650/3250	30/40	2,80
932	424	2.760	3650/3250	30/40	2,80
960	435	2.840	3250	40	2,75
960	435	2.840	3250	40	2,75
960	435	2.840	3750	40	3,50
960	435	2.840	3750	40	3,50
945	416	2.750	2500	40	2,00
945	416	2.750	2500	40	2,00
945	416	2.750	3250	40	2,80
945	416	2.750	3250	40	2,80
945	416	2.750	3250	40	2,80
952	414	2.930	3250	65	5,00
952	414	2.930	3250/3000	65/70	5,00
952	414	2.930	3250/3000	65/70	5,00
885	390	2.620	2180/1950	30/40	3,70
885	390	2.620	2180/1950	30/40	3,70
907	405	2.657	1950	40	3,70
885	395	2.593	1950	40	3,70
885	395	2.593	1950	40	3,70
885	395	2.593	2360	40	5,10
885	395	2.593	2360	40	5,10
965	422	2.870	3550/3150	30/40	4,90
965	422	2.870	3550/3150	30/40	4,90
965	422	2.870	3550/3150	30/40	4,90



Alliance 320
Value Plus

Alliance
FarmPRO 327

BKT AS 504



BKT AW 702

BKT AW 708

BKT AW 711



BKT FL 637

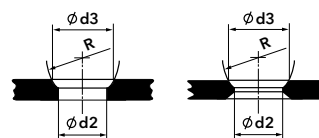

A2/A3

B2/B3

Maße für Kugelansenkung

Bezeichnung	d2	d3	R	Bolzen- gewinde
A2	21,5	27	16	M18x1,5
A3	27	32	18	M22x1,5/M20x1,5
B2	21,5	27	16	M18x1,5
B3	27	32	18	M22x1,5/M20x1,5



Implementräder

Preise und Bestände finden Sie unter www.bohnenkamp.de/shop

Artikel-Nr.	Größe	Last-/ Speed-Index Reifen	PR	Profil	Marke	Felge	Anschluss	Bolzenloch- ausführung	Einpress- tiefe	Breite in mm
59912615	12.5/80 - 18	142 A8	12 PR	AS 504	BKT	11 x 18	6/161/205	A2	0	308
59912653						11 x 18	8/221/275	A3	0	308
59912627	12.5/80 - 18	142 A8	12 PR	AW 702	BKT	11 x 18	6/161/205	A2	0	308
59912647	12.5/80 - 18	148 A8	16 PR	AS 504	BKT	11 x 18	6/161/205	A2	0	308
59912642	12.5/80 - 18	148 A8	16 PR	AW 702	BKT	11 x 18	6/161/205	A2	0	308
59912646						11 x 18	8/221/275	A2	0	308
59918865	340/65 R 18	145 E		571	Alliance	11 x 18	6/161/205	A2	0	340
59918864						11 x 18	8/221/275	A2	0	340
59918870	355/60 R 18	142 J		AR-05	Mitas	11 x 18	6/161/205	A2	0	352
59918875						11 x 18	8/221/275	A2	0	352
59912649	13.0/65 - 18	144 A8	16 PR	AW 702	BKT	11 x 18	6/161/205	A2	0	336
59912971	15.0/70 - 18	145 A8	12 PR	AW 705	BKT	13 x 18	6/161/205	B2	-40	405
59912949						13 x 18	6/161/205	A2	0	405
59912705	440/55 R 18	159 A8 / 159 B		AW 711	BKT	13 x 18	6/161/205	A2	0	410
59912989	16.0/70 - 20	147 A8	10 PR	AS 504	BKT	14 x 20	6/161/205	A2	0	408
59912990	16.0/70 - 20	151 A8	12 PR	AW 705	BKT	14 x 20	6/161/205	A2	0	408
59912996						14 x 20	8/221/275	A2	0	408
10000873						14 x 20	10/281/335	B3	-100	408
59912995	16.0/70 - 20	154 A8	14 PR	AS 504	BKT	14 x 20	6/161/205	A2	0	408
59913289						14 x 20	8/221/275	B3	-50	408
59912998	16.0/70 - 20	156 A8	16 PR	AW 705	BKT	14 x 20	6/161/205	A2	0	408
59912999						14 x 20	8/221/275	A2	0	408
59917603	500/55 - 20	150 A8	10 PR	FarmPRO 327	Alliance	16 x 20	8/221/275	A2	0	503
59917600						16 x 20	10/281/335	A3	0	503
59917619	500/55 - 20	155 A8	12 PR	FarmPRO 327	Alliance	16 x 20	8/221/275	A3	0	503
59911716						16 x 20	10/281/335	A3	0	503
59915297	400/55 - 22.5	154 A8	18 PR	AW 705	BKT	11.75 x 22.5	6/161/205	A2	0	405
59915299						11.75 x 22.5	8/221/275	A2	0	405
59915298						11.75 x 22.5	10/281/335	A3	0	405

Alle Räder in TL Ausführung Standardlackierung für alle Felgen ist silber

Alles auf einen Blick:

Außen ϕ in mm	stat. Halbmesser in mm	Abrollumfang in mm	Tragfähigkeit kpl. Rad in kg	km/h	Luftdruck in bar
987	438	2.892	2650	40	3,70
987	438	2.892	2650	40	3,70
965	432	2.827	2650	40	3,70
987	438	2.892	3150	40	4,90
965	432	2.827	3150	40	4,90
965	432	2.827	3150	40	4,90
892	405	2.717	2900	70	5,00
892	405	2.717	2900	70	5,00
890	398	2.650	2650	80	5,00
890	398	2.650	2650	80	5,00
890	398	2.608	2800	40	4,90
1.010	447	3.092	2900	40	3,10
1.010	447	3.092	2900	40	3,10
945	432	2.893	3850	40	5,00
1.097	487	3.214	3075	40	2,50
1.075	480	3.155	3450	40	3,00
1.075	480	3.155	3450	40	3,00
1.075	480	3.155	3450	40	4,00
1.097	487	3.214	3750	40	3,50
1.097	487	3.214	3750	40	3,50
1.075	480	3.155	4000	40	4,00
1.075	480	3.155	3875	40	4,00
1.055	464	3.063	3350	40	2,40
1.055	464	3.063	3350	40	2,40
1.058	464	3.063	3875	40	3,25
1.058	464	3.063	3875	40	3,25
1.016	443	3.072	3750	40	4,50
1.016	443	3.072	3750	40	4,50
1.016	443	3.072	3750	40	4,50

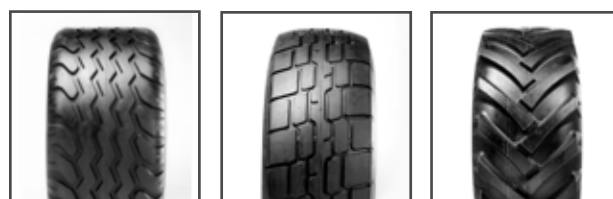

Alliance
FarmPRO 327

Alliance 571

BKT AS 504



BKT AW 702

BKT AW 705

BKT AW 711



Mitas AR-05

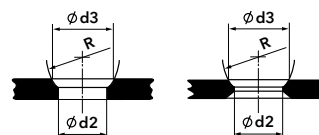

A2/A3

B2/B3

Maße für Kugelansenkung

Bezeichnung	d2	d3	R	Bolzen- gewinde
A2	21,5	27	16	M18x1,5
A3	27	32	18	M22x1,5/M20x1,5
B2	21,5	27	16	M18x1,5
B3	27	32	18	M22x1,5/M20x1,5



Anhängerräder runderneuert

Gelände- und Straßenprofil

Artikel-Nr.	Größe	Last-/Speed-Index Reifen	Profil	Aus- führung	Marke	Felge	Anschluss
59918881 59918880 59918888	435/50 R 19.5	165 A8/161 C	K68, Block		Runderneuert	14.00 x 19.5 14.00 x 19.5 14.00 x 19.5	6/161/205 8/221/275 10/176/225
59919089	385/65 R 22.5	160 K	RE POWER WP TRUCK	3PMSF	Runderneuert	11.75 x 22.5	10/281/335
59919052 59919065	385/65 R 22.5	165 D	Block ECO		Boka Agrar Trans, Runderneuert	11.75 x 22.5 11.75 x 22.5	8/221/275 10/281/335
59919060 59919040 59919070	385/65 R 22.5	160 F	Strasse ECO		Boka Agrar Trans, Runderneuert	11.75 x 22.5 11.75 x 22.5 11.75 x 22.5	8/221/275 8/221/275 10/281/335

Anhängerräder Windpower und Sailun

Artikel-Nr.	Größe	Last-/ Speed-Index Reifen	Profil	Aus- führung	Marke	Roll- widerstand	Nass- haftung	Rollgeräusch Level db	Felge	Anschluss
59967551	215/75 R 17.5	135/133 L	SAR1	3PMSF	Sailun	D	B	B 73	6.75 x 17.5	10/176/225
59967578	215/75 R 17.5	135/133 J	WTL 31	3PMSF	Windpower	D	C	A 71	6.75 x 17.5	10/176/225
10000075	225/75 R 17.5	129/127 M	SAR1	3PMSF	Sailun	D	B	B 73	6.75 x 17.5	6/161/205
59967545	235/75 R 17.5	143/141 L	SAR1	3PMSF	Sailun	D	B	B 73	6.75 x 17.5	6/161/205
59967599 59967583 59967609 59967601	235/75 R 17.5	143/141 J	WTL 31	3PMSF	Windpower	D	B	A 69	6.75 x 17.5 6.75 x 17.5 6.75 x 17.5 6.75 x 17.5	6/161/205 8/221/275 10/176/225 10/176/225
59967638 59967639	285/70 R 19.5	150/148 K	SAR1	3PMSF	Sailun	D	C	B 72	8.25 x 19.5 8.25 x 19.5	6/161/205 8/221/275
59967748 59967741	285/70 R 19.5	150/148 J	WTR 69	3PMSF	Windpower	D	C	B 72	8.25 x 19.5 8.25 x 19.5	6/161/205 8/221/275
10001169	385/55 R 19.5	156 J	WTR 69	3PMSF	Windpower	C	B	B 73	11.75 x 19.5	8/221/275
59967641	435/50 R 19.5	160 J	STL1	3PMSF	Sailun	B	C	B 72	14.00 x 19.5	8/221/275
59967816 59967815	445/45 R 19.5	160 J	T820	3PMSF	Linglong	C	B	B 73	14.00 x 19.5 14.00 x 19.5	6/161/205 8/221/275

Bei runderneuertem Rädern können Maße geringfügig abweichen Alle Räder in TL Ausführung Standardlackierung für alle Felgen ist silber

Alles auf einen Blick:

Bolzenloch- ausführung	Einpress- tiefe	Breite in mm	Außen ø in mm	Tragfähigkeit kpl. Rad in kg	km/h	Luftdruck in bar
B2	0	440	930	4000/2300	40/60	9,00
A3	0	440	930	5150/4625	40/60	9,00
A3	0	440	930	5150/4625	40/60	9,00
B33	0	385	1068	4500	110	9,00
A3	0	379	1070	5150	65	9,00
A3	0	379	1070	5150	65	9,00
A2	0	379	1070	4500	80	8,50
A3	0	379	1070	4500	80	8,50
B33	0	379	1070	4500	80	8,50

Bolzenloch- ausführung	Einpress- tiefe	HMA	Breite in mm	Außen ø in mm	Tragfähigkeit kpl. Rad in kg	km/h	Luftdruck in bar
B33	+130	143	215	767	2180	120	8,60
B33	+130	143	228	758	2180	100	8,30
A2	0		225	783	1850	130	7,25
B33	+130	143	235	797	2725	120	8,60
A2	0		242	791	2725	100	8,30
A2	0		242	791	2725	100	8,30
B33	+130	143	242	791	2725	100	8,30
B33	+133	145	242	791	2575	100	8,30
A2	0		285	895	3350	100	9,00
A33	0		285	895	3350	100	9,00
A2	0		279	893	3350	100	8,30
A33	0		279	893	3350	100	8,30
B3	0		384	927	3850	100	9,00
A2	0		438	931	4500	80	9,00
A2	0		446	895	4500	100	9,00
A3	0		446	895	4500	80	9,00

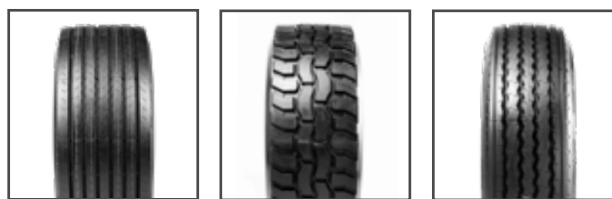

Linglong T820

Runderneuert
K68, Block

Runderneuert
RE POWER WP TRUCK



Runderneuert
Block, ECO

Runderneuert
Strasse, ECO

Sailun SAR1



Sailun STL1

Windpower WTL 3

Windpower WTR 69

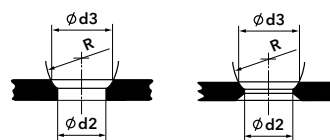

A2/A3/A33

B2/B3/B33

Maße für Kugelansenkung

Bezeichnung	d2	d3	R	Bolzen- gewinde
A2	21,5	27	16	M18x1,5
A3	27	32	18	M22x1,5/M20x1,5
B2	21,5	27	16	M18x1,5
B3	27	32	18	M22x1,5/M20x1,5
A33	26	32	18	M22x1,5/M20x1,5
B33	26	32	18	M22x1,5/M20x1,5



Anhängerräder Windpower und Sailun

Artikel-Nr.	Größe	Last-/Speed-Index Reifen	Profil	Aus- führung	Marke	Roll- widerstand	Nass- haftung	Rollgeräusch Level db	Felge	Anschluss
59918912	315/80 R 22.5	154 / 151 M (156 / 150 L)	WDR 37	3PMSF	Windpower	E	C	B 74	9.00 x 22.5	8/221/275
59967798	385/55 R 22.5	160 J	WTR 69	3PMSF	Windpower	C	C	B 72	11.75 x 22.5	10/281/335
59967979	385/65 R 22.5	160 K	STR1+	3PMSF	Sailun	C	C	B 72	11.75 x 22.5	10/281/335
59967984									11.75 x 22.5	10/281/335
59967879	385/65 R 22.5	160 K (158 L)	WGC 28	3PMSF	Windpower	C	C	B 74	11.75 x 22.5	10/281/335
59919096	385/65 R 22.5	160 K (158 L)	WTR 69	3PMSF	Windpower	C	C	B 72	11.75 x 22.5	8/221/275
59919091									11.75 x 22.5	10/281/335
59919080	385/65 R 22.5	160 K	WTR 69	3PMSF	Windpower	C	C	B 72	11.75 x 22.5	10/281/335
59967885									11.75 x 22.5	10/281/335
59967914	425/65 R 22.5	165 K	WGC 28	3PMSF	Windpower	C	C	B 74	14.00 x 22.5	10/281/335
59967915	425/65 R 22.5	165 K	WTR 69	3PMSF	Windpower	C	D	A 71	14.00 x 22.5	10/281/335
59967968	445/65 R 22.5	169 K	WGC 28	3PMSF	Windpower	C	C	B 74	14.00 x 22.5	10/281/335
59967974									14.00 x 22.5	10/281/335
59967967									14.00 x 22.5	10/281/335
59967969	445/65 R 22.5	169 K	WTR 69	3PMSF	Windpower	C	B	B 73	14.00 x 22.5	10/281/335
59967965									14.00 x 22.5	10/281/335

Bei runderneuertem Rädern können Maße geringfügig abweichen

Alle Räder in TL Ausführung Standardlackierung für alle Felgen ist silber



Alles auf einen Blick:

Bolzenloch- ausführung	Einpress- tiefe	HMA	Breite in mm	Außen ϕ in mm	Tragfähigkeit kpl. Rad in kg	km/h	Luftdruck in bar
A2	0		320	1096	4000	80	8,30
M20/M22	+120		381	1008	4500	100	8,30
B3	0		385	1072	4500	100	9,00
B33	0		385	1072	4500	100	9,00
B33	0		387	1070	4500	110	9,00
A2	0		384	1069	4500	80	9,00
B33	0		384	1069	4500	100	9,00
B33	0		384	1069	4500	110	9,00
M20/M22	+120		384	1069	4500	110	9,00
B33	0		421	1121	5150	100	8,30
B33	0		421	1119	5150	100	8,30
A3	0		450	1148	4500	80	8,30
B33	-50		450	1148	5150	100	
B33	0		450	1148	5600	100	8,30
A3	0		443	1147	4500	80	8,30
B33	0		443	1147	5600	100	8,30



Sailun STR1+



Windpower WDR 37



Windpower WGC 28



Windpower WTR 69

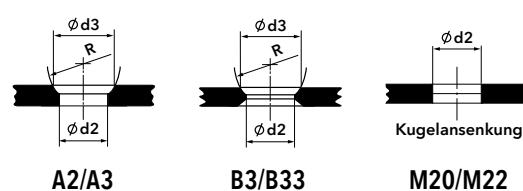

Maße für Kugelansenkung

Bezeichnung	d2	d3	R	Bolzen- gewinde
A2	21,5	27	16	M18x1,5
A3	27	32	18	M22x1,5/M20x1,5
B3	27	32	18	M22x1,5/M20x1,5
B33	26	32	18	M22x1,5/M20x1,5
M20/M22	26	-	-	M22x1,5









Flotationräder Diagonal

Preise und Bestände finden Sie unter www.bohnenkamp.de/shop

Artikel-Nr.	Größe	Last-/ Speed-Index Reifen	PR	Profil	Marke	Felge	Anschluss	Bolzenloch- ausführung	Einpress- tiefe	Breite in mm
59912371	500/50 - 17	157 A8	18 PR	Flotation 648	BKT	16.00 x 17	6/161/205	A2	-35	510
59912370						16.00 x 17	6/161/205	A2	0	510
59912372						16.00 x 17	8/221/275	A2	0	510
59915012	385/65 - 22.5	167 A8	22 PR	Flotation 648	BKT	11.75 x 22.5	6/161/205	A2	0	400
59915013						11.75 x 22.5	8/221/275	A2	0	400
59915011						11.75 x 22.5	10/281/335	A3	0	400
59915306	400/55 - 22.5	150 A8	14 PR	Flotation 558	BKT	11.75 x 22.5	8/221/275	A2	0	405
59915309	400/55 - 22.5	152 A8	16 PR	Flotation 558	BKT	11.75 x 22.5	8/221/275	A2	0	405
59915308						11.75 x 22.5	10/281/335	A3	0	405
59915297	400/55 - 22.5	154 A8	18 PR	AW 705	BKT	11.75 x 22.5	6/161/205	A2	0	405
59915299						11.75 x 22.5	8/221/275	A2	0	405
59915298						11.75 x 22.5	10/281/335	A3	0	405
59915030	400/60 - 22.5	160 A8	18 PR	Flotation 648	BKT	11.75 x 22.5	6/161/205	A2	0	400
59915033						11.75 x 22.5	8/221/275	A2	0	400
59915034						11.75 x 22.5	8/221/275	A3	0	400
59913325	500/45 - 22.5	154 A8	16 PR	Flotation 328	Alliance	16.00 x 22.5	6/161/205	A2	-50	500
59913317						16.00 x 22.5	8/221/275	B2	-50	500
10000261						16.00 x 22.5	8/221/275	A2	0	500
59913326						16.00 x 22.5	10/281/335	B3	-50	500
59913319						16.00 x 22.5	10/281/335	A3	0	500
59917307	500/45 - 22.5	148 A8	12 PR	Flotation 558	BKT	16.00 x 22.5	8/221/275	B2	-50	500
59917305						16.00 x 22.5	8/221/275	A3	0	500
59917311						16.00 x 22.5	10/281/335	B3	-50	500
59917309						16.00 x 22.5	10/281/335	A3	0	500
59917316	500/45 - 22.5	154 A8	16 PR	Flotation 558	BKT	16.00 x 22.5	6/161/205	A2	-50	500
59917317						16.00 x 22.5	8/221/275	B2	-50	500
59917315						16.00 x 22.5	8/221/275	A2	0	500
59917319						16.00 x 22.5	10/281/335	A3	0	500
59917653	500/50 - 22.5	158 A8	16 PR	Flotation 648	BKT	16.00 x 22.5	8/221/275	A2	0	500
59917656						16.00 x 22.5	8/221/275	A3	0	500
59917610						16.00 x 22.5	10/281/335	A3	0	500
59911776	500/60 - 22.5	163 A8	16 PR	328 Value Plus	Alliance	16.00 x 22.5	8/221/275	A3	0	500
59911777						16.00 x 22.5	10/281/335	B3	-50	500
59911775						16.00 x 22.5	10/281/335	A3	0	500
59913367	500/60 - 22.5	165 A8	18 PR	Flotation 328	Alliance	16.00 x 22.5	8/221/275	A2	-50	500
59913366						16.00 x 22.5	8/221/275	A3	0	500
59913365						16.00 x 22.5	10/281/335	A3	0	500

Alle Räder in TL Ausführung Standardlackierung für alle Felgen ist silber

Alles auf einen Blick:

 Außen \varnothing in mm	 stat. Halbmesser in mm	 Abrollumfang in mm	 Tragfähigkeit kpl. Rad in kg	 km/h	 Luftdruck in bar
945	416	2.750	4125	40	4,00
945	416	2.750	4125	40	4,00
945	416	2.750	4125	40	4,00
1.070	475	3.233	5450	40	5,90
1.070	475	3.233	5450	40	5,90
1.070	475	3.233	5450	40	5,90
1.020	445	3.084	3350	40	3,50
1.020	445	3.084	3550	40	4,00
1.020	445	3.084	3550	40	4,00
1.016	443	3.072	3750	40	4,50
1.016	443	3.072	3750	40	4,50
1.016	443	3.072	3750	40	4,50
1.070	475	3.233	4500	40	4,30
1.070	475	3.233	4500	40	4,30
1.070	475	3.233	4500	40	4,30
1.030	455	3.153	3750	40	3,60
1.030	455	3.153	3750	40	3,60
1.030	455	3.153	3750	40	3,60
1.030	455	3.153	3750	40	3,60
1.030	455	3.153	3750	40	3,60
1.045	471	3.167	3150	40	2,70
1.045	471	3.167	3150	40	2,70
1.045	471	3.167	3150	40	2,70
1.045	471	3.167	3150	40	2,70
1.045	471	3.167	3750	40	3,60
1.045	471	3.167	3750	40	3,60
1.045	471	3.167	3750	40	3,60
1.045	471	3.167	3750	40	3,60
1.045	471	3.167	3750	40	3,60
1.070	475	3.200	4250	40	3,00
1.070	475	3.200	4250	40	3,00
1.070	475	3.200	4250	40	3,00
1.170	510	3.460	4875	40	3,20
1.170	510	3.460	4875	40	3,20
1.170	510	3.460	4875	40	3,20
1.170	510	3.470	5150	40	3,60
1.170	510	3.470	5150	40	3,60
1.170	510	3.470	5150	40	3,60

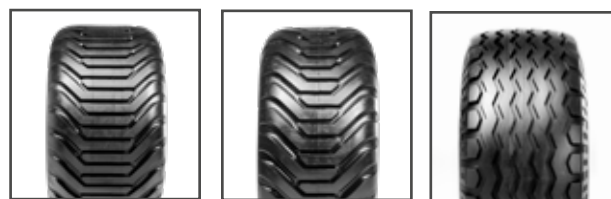

Alliance Flotation 328 Alliance 328 Value Plus BKT AW 705



BKT Flotation 558 BKT Flotation 648

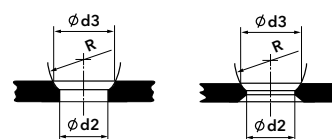

A2/A3

B2/B3

Maße für Kugelansenkung

Bezeichnung	d2	d3	R	Bolzen- gewinde
A2	21,5	27	16	M18x1,5
A3	27	32	18	M22x1,5/M20x1,5
B2	21,5	27	16	M18x1,5
B3	27	32	18	M22x1,5/M20x1,5



Flotationräder Diagonal

Preise und Bestände finden Sie unter www.bohnenkamp.de/shop

Artikel-Nr.	Größe	Last-/ Speed-Index Reifen	PR	Profil	Marke	Felge	Anschluss	Bolzenloch- ausführung	Einpress- tiefe	Breite in mm
10000891	500/60 - 22.5	163 A8	16 PR	Flotation 331	Alliance	16.00 x 22.5	8/221/275	A3	-50	503
59917352	500/60 - 22.5	163 A8	16 PR	Flotation V-Line	BKT	16.00 x 22.5	8/221/275	B2	-50	500
59917350						16.00 x 22.5	8/221/275	A2	0	500
59917354						16.00 x 22.5	10/281/335	A3	0	500
59913382						16.00 x 22.5	6/161/205	A2	-50	550
59913386	550/45 - 22.5	159 A8	16 PR	Flotation 328	Alliance	16.00 x 22.5	8/221/275	B2	-50	550
59913384						16.00 x 22.5	8/221/275	A2	0	550
59913388						16.00 x 22.5	10/281/335	A3	0	550
59940056						16.00 x 22.5	10/281/335	A3	+50	550
59911779						16.00 x 22.5	8/221/275	A3	0	550
59911783	550/45 - 22.5	159 A8	16 PR	328 Value Plus	Alliance	16.00 x 22.5	10/281/335	B3	-50	550
59911778						16.00 x 22.5	10/281/335	A3	0	550
59917382	550/45 - 22.5	159 A8	16 PR	Flotation 648	BKT	16.00 x 22.5	8/221/275	B2	-50	550
59917380						16.00 x 22.5	8/221/275	A2	0	550
59917384						16.00 x 22.5	10/281/335	A3	0	550
59917399	550/45 - 22.5	166 A8	20 PR	Flotation 648 T	BKT	16.00 x 22.5	8/221/275	B2	-50	550
59917398						16.00 x 22.5	8/221/275	A3	0	550
59917395						16.00 x 22.5	10/281/335	A3	0	550
59915279						16.00 x 22.5	8/221/275	A2	0	550
59915280	550/60 - 22.5	160 D / 159 E	16 PR	Flotation 328	Alliance	16.00 x 22.5	8/221/275	A3	0	550
59915276						16.00 x 22.5	10/281/335	A3	0	550
59911788	550/60 - 22.5	166 A8	16 PR	328 Value Plus	Alliance	16.00 x 22.5	8/221/275	A3	0	550
59911789						16.00 x 22.5	10/281/335	B3	-50	550
59911784						16.00 x 22.5	10/281/335	A3	0	550
59917372						16.00 x 22.5	8/221/275	B2	-50	550
59917370	550/60 - 22.5	167 A8	16 PR	Flotation V-Line	BKT	16.00 x 22.5	8/221/275	A2	0	550
59917376						16.00 x 22.5	10/281/335	B3	-50	550
59917374						16.00 x 22.5	10/281/335	A3	0	550
59917377						16.00 x 22.5	10/281/335	B3	+30	550
10001011						600/40 - 22.5	154 A8	12 PR	Flotation 331	Alliance
59913475	600/40 - 22.5	173 A6 / 169 A8	18 PR	Flotation 331	Alliance	20.00 x 22.5	8/221/275	A3	0	600
59913524	600/50 - 22.5	158 D / 157 E	16 PR	Flotation 328	Alliance	20.00 x 22.5	10/281/335	A3	-100	600
59913522						20.00 x 22.5	10/281/335	A3	-50	600
59913520						20.00 x 22.5	10/281/335	A3	0	600
59917402	600/50 - 22.5	165 A8	16 PR	Flotation 648	BKT	20.00 x 22.5	8/221/275	A3	-50	600
59917400						20.00 x 22.5	8/221/275	A2	0	600
59917406						20.00 x 22.5	10/281/335	A3	-50	600
59917404						20.00 x 22.5	10/281/335	A3	0	600

Alle Räder in TL Ausführung Standardlackierung für alle Felgen ist silber

Alles auf einen Blick:

Außen ø in mm	stat. Halbmesser in mm	Abrollumfang in mm	Tragfähigkeit kpl. Rad in kg	km/h	Luftdruck in bar
1.172	519	3.472	4875	40	3,20
1.170	510	3.489	4875	40	3,20
1.170	510	3.489	4875	40	3,20
1.170	510	3.489	4875	40	3,20
1.070	476	3.175	4375	40	2,80
1.070	476	3.175	4375	40	2,80
1.070	476	3.175	4375	40	2,80
1.070	476	3.175	4375	40	2,80
1.070	475	3.203	4375	40	2,80
1.070	470	3.105	5250	40	3,80
1.070	470	3.105	5250	40	3,80
1.070	470	3.105	5250	40	3,80
1.070	475	3.203	4375	40	2,80
1.070	475	3.203	4375	40	2,80
1.070	475	3.203	4375	40	2,80
1.070	475	3.203	5300	40	4,00
1.070	475	3.203	5300	40	4,00
1.070	475	3.203	5300	40	4,00
1.238	540	3.580	4500/4375	65/70	2,80
1.238	540	3.580	4500/4375	65/70	2,80
1.238	540	3.580	4500/4375	65/70	2,80
1.238	540	3.765	5300	40	3,00
1.238	540	3.765	5300	40	3,00
1.238	540	3.765	5300	40	3,00
1.240	540	3.725	5450	40	2,80
1.240	540	3.725	5450	40	2,80
1.240	540	3.725	5450	40	2,80
1.240	540	3.725	5450	40	2,80
1.240	540	3.725	5450	40	2,80
1.090	480	3.356	3750	40	2,10
1.100	505	3.280	6500/5600	30/40	6,00
1.170	520	3.450	4250/4125	65/70	2,60
1.170	520	3.450	4250/4125	65/70	2,60
1.170	520	3.450	4250/4125	65/70	2,60
1.170	510	3.501	5150	40	2,60
1.170	510	3.501	5150	40	2,60
1.170	510	3.501	5150	40	2,60
1.170	510	3.501	5150	40	2,60

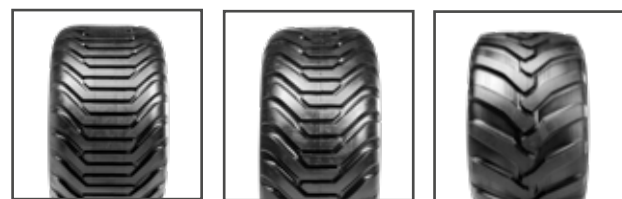

Alliance Flotation 328

Alliance 328
Value Plus

Alliance Flotation 331



BKT Flotation 648 /
Flotation 648 T

BKT Flotation V-Line

Implement-/
Flotationräder

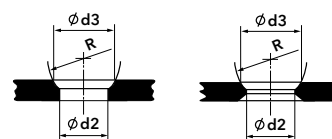

A2/A3

B2/B3

Maße für Kugelansenkung

Bezeichnung	d2	d3	R	Bolzen- gewinde
A2	21,5	27	16	M18x1,5
A3	27	32	18	M22x1,5/M20x1,5
B2	21,5	27	16	M18x1,5
B3	27	32	18	M22x1,5/M20x1,5



Flotationräder Diagonal

Preise und Bestände finden Sie unter www.bohnenkamp.de/shop

Artikel-Nr.	Größe	Last-/ Speed-Index Reifen	PR	Profil	Marke	Felge	Anschluss	Bolzenloch- ausführung	Einpress- tiefe	Breite in mm
59915495	600/55 - 22.5	162 D / 161 E	16 PR	Flotation 328	Alliance	20.00 x 22.5	10/281/335	A3	-50	600
59915519						20.00 x 22.5	10/281/335	A3	0	600
59917432	600/55 - 22.5	169 A8	16 PR	Flotation 648	BKT	20.00 x 22.5	8/221/275	A3	-50	600
59917430						20.00 x 22.5	8/221/275	A2	0	600
59917436						20.00 x 22.5	10/281/335	A3	-50	600
59917434						20.00 x 22.5	10/281/335	A3	0	600
59917462	700/40 - 22.5	166 A8	16 PR	Flotation 648	BKT	24.00 x 22.5	8/221/275	A2	-50	700
59917464						24.00 x 22.5	10/281/335	A3	0	700
59915583	700/50 - 22.5	167 D / 166 E	16 PR	Flotation 328	Alliance	24.00 x 22.5	10/281/335	A3	-100	700
59915584						24.00 x 22.5	10/281/335	A3	-50	700
59915585						24.00 x 22.5	10/281/335	A3	0	700
59917492	700/50 - 22.5	174 A8	16 PR	Flotation 648	BKT	24.00 x 22.5	8/221/275	A2	-50	700
59917496						24.00 x 22.5	10/281/335	A3	-50	700
59917494						24.00 x 22.5	10/281/335	A3	0	700
59917483	710/40 - 22.5	173 A8		TR 678	BKT	24.00 x 22.5	10/281/335	A3	-50	707
59917509						24.00 x 22.5	10/281/335	A3	0	707
10000756	800/35 - 22.5	169 A8 / 162 D	16 PR	128	Alliance	28.00 x 22.5	8/221/275	A3	-75	800
59914215	28 L - 26	173 A8	16 PR	330	Alliance	25 x 26	10/281/335	B3	-50	714
59914210						25 x 26	10/281/335	A3	0	714
10000937	28 L - 26	160 A6 / 157 A8	16 PR	TR 390	BKT	25 x 26	10/281/335	B3	-50	714
10000936						25 x 26	10/281/335	A3	0	714
59915184	28 L - 26	172 A6 / 168 A8	20 PR	TR 390	BKT	25 x 26	10/281/335	B3	-50	714
59915183						25 x 26	10/281/335	A3	0	714
59915719	600/55 - 26.5	170 A8	16 PR	Flotation 331	Alliance	20.00 x 26.5	10/281/335	B3	-50	591
59915718						20.00 x 26.5	10/281/335	B3	0	591
59915746	600/55 - 26.5	167 B / 163 C	16 PR	Flotation 328	Alliance	20.00 x 26.5	10/281/335	A3	-50	600
59915745						20.00 x 26.5	10/281/335	A3	0	600
59917532	600/55 - 26.5	170 A8	16 PR	Flotation 648	BKT	20.00 x 26.5	8/221/275	A2	-50	600
59917530						20.00 x 26.5	8/221/275	A2	0	600
59917536						20.00 x 26.5	10/281/335	A3	-50	600
59917534						20.00 x 26.5	10/281/335	A3	0	600
59915939	700/50 - 26.5	170 B / 166 C	16 PR	Flotation 328	Alliance	24.00 x 26.5	8/221/275	A2	-50	700
59915943						24.00 x 26.5	10/281/335	A3	-100	700
59915942						24.00 x 26.5	10/281/335	A3	-50	700
59915941						24.00 x 26.5	10/281/335	A3	0	700

Alle Räder in TL Ausführung Standardlackierung für alle Felgen ist silber

Alles auf einen Blick:

Außen \varnothing in mm	stat. Halbmesser in mm	Abrollumfang in mm	Tragfähigkeit kpl. Rad in kg	km/h	Luftdruck in bar
1.270	550	3.650	4750/4625	65/70	2,80
1.270	550	3.650	4750/4625	65/70	2,80
1.230	540	3.716	5800	40	2,60
1.230	540	3.716	5800	40	2,60
1.230	540	3.716	5800	40	2,60
1.230	540	3.716	5800	40	2,60
1.170	510	3.537	5300	40	2,20
1.170	510	3.537	5300	40	2,20
1.270	550	3.650	5450/5300	65/70	2,80
1.270	550	3.650	5450/5300	65/70	2,80
1.270	550	3.650	5450/5300	65/70	2,80
1.270	550	3.775	6700	40	2,40
1.270	550	3.775	6700	40	2,40
1.270	550	3.775	6700	40	2,40
1.165	545	3.624	6500	40	6,00
1.165	545	3.624	6500	40	6,00
1.170	523	3.508	5800/4750	40/65	2,60
1.590	702	4.627	6500	40	2,20
1.590	702	4.627	6500	40	2,20
1.560	690	4.545	4500/4125	30/40	1,90
1.560	690	4.545	4500/4125	30/40	1,90
1.560	690	4.545	6300/5600	30/40	2,80
1.560	690	4.545	6300/5600	30/40	2,80
1.333	580	3.850	6000	40	2,60
1.333	580	3.850	6000	40	2,60
1.333	580	3.850	5450/4875	50/60	2,60
1.333	580	3.850	5450/4875	50/60	2,60
1.354	581	4.017	6000	40	2,60
1.354	581	4.017	6000	40	2,60
1.354	581	4.017	6000	40	2,60
1.354	581	4.017	6000	40	2,60
1.333	580	3.974	6000/5300	50/60	2,40
1.333	580	3.974	6000/5300	50/60	2,40
1.333	580	3.974	6000/5300	50/60	2,40
1.333	580	3.974	6000/5300	50/60	2,40



Alliance 128

Alliance Flotation 328

Alliance 330



Alliance Flotation 331

BKT Flotation 648

BKT TR 390



BKT TR 678

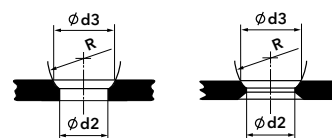

A2/A3

B3

Maße für Kugelansenkung

Bezeichnung	d2	d3	R	Bolzen- gewinde
A2	21,5	27	16	M18x1,5
A3	27	32	18	M22x1,5/M20x1,5
B3	27	32	18	M22x1,5/M20x1,5



Flotationräder Diagonal

Preise und Bestände finden Sie unter www.bohnenkamp.de/shop

Artikel-Nr.	Größe	Last-/ Speed-Index Reifen	PR	Profil	Marke	Felge	Anschluss	Bolzenloch- ausführung	Einpress- tiefe	Breite in mm
59917562	700/50 - 26.5	174 A8	16 PR	Flotation 648	BKT	24.00 x 26.5	8/221/275	A2	-50	700
59917560						24.00 x 26.5	8/221/275	A2	0	700
59917566						24.00 x 26.5	10/281/335	A3	-50	700
59917564						24.00 x 26.5	10/281/335	A3	0	700
59913990	800/45 - 26.5	177 A8	16 PR	Flotation 328	Alliance	28.00 x 26.5	10/281/335	A3	-50	800
59913985						28.00 x 26.5	10/281/335	A3	0	800
59917592	800/45 - 26.5	177 A8	16 PR	Flotation 648	BKT	28.00 x 26.5	10/281/335	A3	-50	800
59917590						28.00 x 26.5	10/281/335	A3	0	800
59913910	650/65 - 30.5	179 A8	16 PR	Flotation 648	BKT	20.00 x 30.5	10/281/335	A3	-50	650
59917920						20.00 x 30.5	10/281/335	A3	0	650
59913866	750/60 - 30.5	179 B / 172 D	16 PR	Flotation 328	Alliance	24.00 x 30.5	10/281/335	A3	-50	750
59913865						24.00 x 30.5	10/281/335	A3	0	750
59913841	750/60 - 30.5	182 A8	16 PR	Flotation 648	BKT	24.00 x 30.5	10/281/335	A3	-50	750
59913840						24.00 x 30.5	10/281/335	A3	0	750
59913852	850/50 - 30.5	186 A8	16 PR	Flotation 328	Alliance	28.00 x 30.5	10/281/335	A3	-50	850
59913850						28.00 x 30.5	10/281/335	A3	0	850
59913880	850/50 - 30.5	186 A8	16 PR	Flotation 648	BKT	28.00 x 30.5	10/281/335	A3	-50	850
59913879						28.00 x 30.5	10/281/335	A3	0	850

Alle Räder in TL Ausführung Standardlackierung für alle Felgen ist silber



Alles auf einen Blick:

Außen ϕ in mm	stat. Halbmesser in mm	Abrollumfang in mm	Tragfähigkeit kpl. Rad in kg	km/h	Luftdruck in bar
1.354	581	4.017	6700	40	2,40
1.354	581	4.017	6700	40	2,40
1.354	581	4.017	6700	40	2,40
1.354	581	4.017	6700	40	2,40
1.393	614	4.050	7300	40	2,20
1.393	614	4.050	7300	40	2,20
1.354	581	4.017	7300	40	2,20
1.354	581	4.017	7300	40	2,20
1.650	710	4.935	7750	40	2,20
1.650	710	4.935	7750	40	2,20
1.670	720	4.790	7750/6300	50/65	2,50
1.670	720	4.790	7750/6300	50/65	2,50
1.650	710	4.935	8500	40	2,20
1.650	710	4.935	8500	40	2,20
1.670	720	4.790	9500	40	2,20
1.670	720	4.790	9500	40	2,20
1.650	710	4.935	9500	40	2,20
1.650	710	4.935	9500	40	2,20



Alliance Flotation 328 BKT Flotation 648

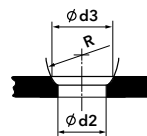

A2/A3

Maße für Kugellagerung

Bezeichnung	d2	d3	R	Bolzen- gewinde
A2	21,5	27	16	M18x1,5
A3	27	32	18	M22x1,5/M20x1,5





Flotationräder Radial

Preise und Bestände finden Sie unter www.bohnenkamp.de/shop

Artikel-Nr.	Größe	Last-/ Speed-Index Reifen	Profil	Marke	Felge	Anschluss	Bolzenloch- ausführung	Einpress- tiefe	Breite in mm
59912070	425/55 R 17	140 A8 / 129 D	Ridemax FL 693 M	BKT	13.00 x 17	6/161/205	A2	0	420
59912073					13.00 x 17	8/221/275	A2	0	420
59912072					13.00 x 17	8/221/275	A3	0	420
59911772	500/50 R 17	149 D	882	Alliance	16.00 x 17	6/161/205	A2	-35	503
59911771					16.00 x 17	6/161/205	A2	0	503
59911773					16.00 x 17	8/221/275	A2	0	503
59911774					16.00 x 17	8/221/275	A3	0	503
59916056	500/50 R 17	149 D / 146 E	Ridemax FL 693 M	BKT	16.00 x 17	6/161/205	A2	0	503
59916057					16.00 x 17	8/221/275	A3	0	503
59912074	VF 400/45 R 17.5	159 D	Ridemax FL 693 M	BKT	14.00 x 17.5	8/221/275	A2	0	400
59913301	500/45 R 20	157 A8	Flotmaster 381	Alliance	16 x 20	8/221/275	A2	0	502
59913303					16 x 20	10/281/335	A3	0	502
59916334	VF 445/50 R 22.5	167 D	Agriflex 381 +	Alliance	14.00 x 22.5	10/281/335	A3	0	437
59917465	500/45 R 22.5	146 D	Ridemax FL 693 M	BKT	16.00 x 22.5	8/221/275	A3	-50	503
59917342					16.00 x 22.5	8/221/275	A2	0	503
59917340					16.00 x 22.5	10/281/335	A3	0	503
59917339					16.00 x 22.5	10/281/335	B3	+30	503
59913363					500/60 R 22.5	155 D	390	Alliance	16.00 x 22.5
59913362	16.00 x 22.5	10/281/335	A3	0					510
59911781	500/60 R 22.5	155 D	882	Alliance	16.00 x 22.5	8/221/275	A2	-50	510
59911780					16.00 x 22.5	8/221/275	A3	0	510
59911782					16.00 x 22.5	10/281/335	A3	0	510
59917326	500/60 R 22.5	166 A8 / 155 D	FL 630 Ultra	BKT	16.00 x 22.5	8/221/275	A3	-50	503
59917325					16.00 x 22.5	8/221/275	A3	0	503
59917328					16.00 x 22.5	10/281/335	A3	-50	503
59917327					16.00 x 22.5	10/281/335	A3	0	503
59917331					500/60 R 22.5	155 D / 152 E	Ridemax FL 693 M	BKT	16.00 x 22.5
59917330	16.00 x 22.5	8/221/275	A3	0					503
59917332	16.00 x 22.5	10/281/335	A3	0					503
59915060	550/45 R 22.5	151 E	380	Alliance	16.00 x 22.5	8/221/275	A2	0	550
59915062					16.00 x 22.5	10/281/335	A3	0	550
59915936	560/45 R 22.5	146 D	Flotmaster 381	Alliance	16.00 x 22.5	8/221/275	A2	0	540
59915925					16.00 x 22.5	10/281/335	A3	-50	540
59915952	560/45 R 22.5	152 D	380	Alliance	16.00 x 22.5	10/281/335	A3	-50	543
59915951					16.00 x 22.5	10/281/335	A3	0	543
59915917	560/45 R 22.5	152 D	390	Alliance	16.00 x 22.5	10/281/335	A3	-50	545
59915916					16.00 x 22.5	10/281/335	A3	0	545

Alle Räder in TL Ausführung Standardlackierung für alle Felgen ist silber

Alles auf einen Blick:

Außen ϕ in mm	stat. Halbmesser in mm	Abrollumfang in mm	Tragfähigkeit kpl. Rad in kg	km/h	Luftdruck in bar
894	397	2.704	2500	40	4,00
894	397	2.704	2500	40	4,00
894	397	2.704	2500	40	4,00
932	409	2.833	3250	65	5,00
932	409	2.833	3250	65	5,00
932	409	2.833	3250	65	5,00
932	409	2.833	3000	65	5,00
932	424	2.913	3000	65	5,00
932	424	2.913	3000	65	5,00
800	357	2.448	5200	40	6,00
958	412	2.877	2900	40	4,00
958	412	2.877	2900	40	4,00
1.016	454	3.123	4500	65	6,70
1.022	455	3.114	3000	65	4,00
1.022	455	3.114	3000	65	4,00
1.022	455	3.114	3000	65	4,00
1.022	455	3.114	3000	65	4,00
1.180	529	3.616	3875	65	4,00
1.180	529	3.616	3875	65	4,00
1.180	529	3.616	3875	65	4,00
1.180	529	3.616	3875	65	4,00
1.180	529	3.616	3875	65	4,00
1.172	521	3.592	5300/3875	40/65	4,00
1.172	521	3.592	5300/3875	40/65	4,00
1.172	521	3.592	5300/3875	40/65	4,00
1.172	521	3.592	5300/3875	40/65	4,00
1.172	531	3.577	3875	65	4,00
1.172	531	3.577	3875/3550	65/70	4,00
1.172	531	3.577	3875/3550	65/70	4,00
1.070	489	3.275	3450	70	4,00
1.070	489	3.275	3450	70	4,00
1.080	485	3.304	3000	65	3,20
1.080	485	3.304	3000	65	3,20
1.075	485	3.265	3550	65	4,00
1.075	485	3.265	3550	65	4,00
1.078	483	3.291	3550	65	4,00
1.078	483	3.291	3550	65	4,00



Alliance 380

Alliance Agriflex 381 +

Alliance Flotmaster 381

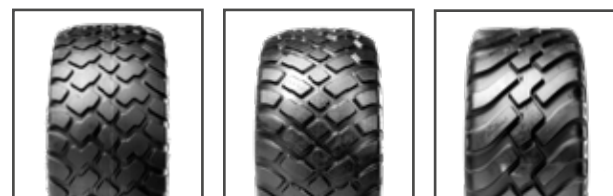

Alliance 390

Alliance 882

BKT FL 630 Ultra



BKT Ridemax FL 693 M

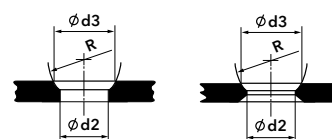

A2/A3

B2/B3

Maße für Kugelansenkung

Bezeichnung	d2	d3	R	Bolzen- gewinde
A2	21,5	27	16	M18x1,5
A3	27	32	18	M22x1,5/M20x1,5
B2	21,5	27	16	M18x1,5
B3	27	32	18	M22x1,5/M20x1,5



Flotationräder Radial







Preise und Bestände finden Sie unter www.bohnenkamp.de/shop

Artikel-Nr.	Größe	Last-/ Speed-Index Reifen	Profil	Marke	Felge	Anschluss	Bolzenloch- ausführung	Einpress- tiefe	Breite in mm
59915944	560/45 R 22.5	152 D	885	Alliance	16.00 x 22.5	10/281/335	A3	-50	543
59915937					16.00 x 22.5	10/281/335	A3	0	543
59913747	560/45 R 22.5	163 A8 / 152 D	FL 630 Ultra	BKT	16.00 x 22.5	8/221/275	A3	-50	543
59913746					16.00 x 22.5	8/221/275	A2	0	543
59913745					16.00 x 22.5	10/281/335	B3	-50	543
59913744					16.00 x 22.5	10/281/335	A3	0	543
59917450					16.00 x 22.5	10/281/335	A3	0	543
10001256	560/45 R 22.5	152 D / 149 E	Ridemax FL 693 M	BKT	16.00 x 22.5	8/221/275	A3	-50	543
59913708					16.00 x 22.5	8/221/275	A2	0	543
59913709					16.00 x 22.5	10/281/335	A3	0	543
59914403	560/45 R 22.5	152 D	Country King	Nokian	16.00 x 22.5	10/281/335	A3	-50	564
59914402					16.00 x 22.5	10/281/335	A3	0	564
59915120	560/55 R 22.5	158 D / 155 E	Ridemax FL 693 M	BKT	16.00 x 22.5	8/221/275	A2	0	543
59915119					16.00 x 22.5	10/281/335	A3	0	543
59915632	560/60 R 22.5	161 E	380	Alliance	16.00 x 22.5	8/221/275	A2	0	554
59915636					16.00 x 22.5	10/281/335	A3	0	554
59915677	VF 560/60 R 22.5	163 D	Agriflex 389 +	Alliance	16.00 x 22.5	8/221/275	A2	-50	565
59915676					16.00 x 22.5	8/221/275	A2	0	565
59915679					16.00 x 22.5	10/281/335	A3	-50	565
59915678					16.00 x 22.5	10/281/335	A3	0	565
59915643	560/60 R 22.5	164 D	390	Alliance	16.00 x 22.5	10/281/335	A3	0	572
59915653	560/60 R 22.5	165 D	882	Alliance	16.00 x 22.5	8/221/275	B2	-50	565
59915652					16.00 x 22.5	8/221/275	A2	0	565
59915647	560/60 R 22.5	170 D	390 Industrial HD	Alliance	16.00 x 22.5	10/281/335	A3	0	556
59915618	560/60 R 22.5	172 D	380 Industrial HD	Alliance	16.00 x 22.5	10/281/335	A3	-50	550
59915616					16.00 x 22.5	10/281/335	A3	0	550
59913741	560/60 R 22.5	161 D	FL 630 Super	BKT	16.00 x 22.5	10/281/335	B3	-50	543
59913740					16.00 x 22.5	10/281/335	A3	0	543
59913751	560/60 R 22.5	172 A8 / 161 D	FL 630 Ultra	BKT	16.00 x 22.5	8/221/275	A3	-50	543
59913750					16.00 x 22.5	8/221/275	A2	0	543
59940037					16.00 x 22.5	8/221/275	A3	+50	543
59913749					16.00 x 22.5	10/281/335	A3	-50	543
59913748					16.00 x 22.5	10/281/335	A3	0	543
59913728					16.00 x 22.5	8/221/275	A2	0	543
59913743	560/60 R 22.5	165 D / 162 E	Ridemax FL 693 M	BKT	16.00 x 22.5	10/281/335	A3	-50	543
59913729					16.00 x 22.5	10/281/335	A3	0	543
59913733					16.00 x 22.5	10/281/335	B3	+30	543
59913733					16.00 x 22.5	10/281/335	B3	+30	543

Alle Räder in TL Ausführung Standardlackierung für alle Felgen ist silber

HD = Heavy Duty

Alles auf einen Blick:

 Außen ϕ in mm	 stat. Halbmesser in mm	 Abrollumfang in mm	 Tragfähigkeit kpl. Rad in kg	 km/h	 Luftdruck in bar
1.060	478	3.260	3550	65	4,00
1.060	478	3.260	3550	65	4,00
1.076	490	3.290	4875/3550	40/65	4,00
1.076	490	3.290	4875/3550	40/65	4,00
1.076	490	3.290	4875/3550	40/65	4,00
1.076	490	3.290	4875/3550	40/65	4,00
1.076	484	3.303	4875/3550	40/65	4,00
1.076	457	3.306	3550/3250	65/70	4,00
1.076	457	3.306	3550/3250	65/70	4,00
1.076	457	3.306	3550/3250	65/70	4,00
1.076	474	3.280	3550	65	4,00
1.076	474	3.280	3550	65	4,00
1.180	533	3.614	4250/3875	65/70	4,00
1.180	533	3.614	4250/3875	65/70	4,00
1.245	559	3.800	4625	70	4,00
1.245	559	3.800	4625	70	4,00
1.250	538	3.759	4875	65	2,80
1.250	538	3.759	4875	65	2,80
1.250	538	3.759	4875	65	2,80
1.250	538	3.759	4875	65	2,80
1.252	558	3.671	5000	65	4,00
1.244	555	3.650	5000	65	4,20
1.244	555	3.650	5150	65	4,20
1.252	559	3.834	5400	65	5,00
1.249	553	3.849	5300	65	5,00
1.249	553	3.849	5400	65	5,00
1.244	549	3.785	4625	65	4,00
1.244	549	3.785	4625	65	4,00
1.244	535	3.760	6300/4625	40/65	4,00
1.244	535	3.760	6300/4625	40/65	4,00
1.244	535	3.760	6300/4626	40/65	5,00
1.244	535	3.760	6300/4625	40/65	4,00
1.244	535	3.760	6300/4625	40/65	4,00
1.244	552	3.767	5150/4750	65/70	5,00
1.244	552	3.767	5150/4750	65/70	5,00
1.244	552	3.767	5150/4750	65/70	5,00
1.244	552	3.767	5150	65	5,00

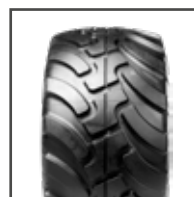

Alliance 380 /
380 Industrial HD

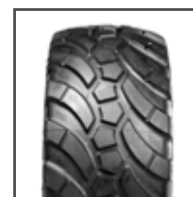

Alliance Agriflex
389 +



Alliance 390 /
390 Industrial HD

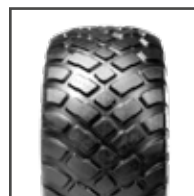

Alliance 882

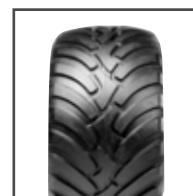

Alliance 885

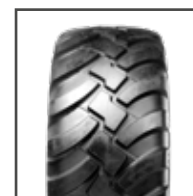

BKT FL 630 Super

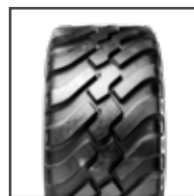

BKT FL 630 Ultra



BKT FL 639



BKT Ridemax
FL 693 M

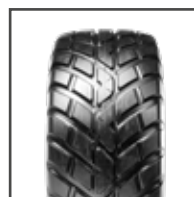

Nokian Country King

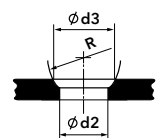

A2/A3

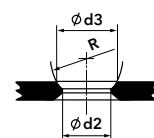

B2/B3

Maße für Kugelansenkung

Bezeichnung	d2	d3	R	Bolzen- gewinde
A2	21,5	27	16	M18x1,5
A3	27	32	18	M22x1,5/M20x1,5
B2	21,5	27	16	M18x1,5
B3	27	32	18	M22x1,5/M20x1,5



Flotationräder Radial

Preise und Bestände finden Sie unter www.bohnenkamp.de/shop

Artikel-Nr.	Größe	Last-/ Speed-Index Reifen	Profil	Marke	Felge	Anschluss	Bolzenloch- ausführung	Einpress- tiefe	Breite in mm
59914405	560/60 R 22.5	161 D	Country King	Nokian	16.00 x 22.5	10/281/335	A3	-50	564
59914404					16.00 x 22.5	10/281/335	A3	0	564
59915682	580/65 R 22.5	166 D	882	Alliance	16.00 x 22.5	10/281/335	A3	-50	575
59915681					16.00 x 22.5	10/281/335	A3	0	575
59915666	580/65 R 22.5	166 D	885	Alliance	16.00 x 22.5	10/281/335	A3	-50	574
59915662					16.00 x 22.5	10/281/335	A3	0	574
59913736	580/65 R 22.5	166 D / 163 E	Ridemax FL 693 M	BKT	16.00 x 22.5	10/281/335	B3	-50	577
59913735					16.00 x 22.5	10/281/335	A3	0	577
59914407	580/65 R 22.5	166 D	Country King	Nokian	16.00 x 22.5	10/281/335	A3	-50	577
59914406					16.00 x 22.5	10/281/335	A3	0	577
59913564	600/50 R 22.5	159 D	885	Alliance	20.00 x 22.5	10/281/335	A3	0	606
59913528	600/50 R 22.5	159 E	390	Alliance	20.00 x 22.5	10/281/335	A3	-50	583
59913526					20.00 x 22.5	10/281/335	A3	0	583
59911787	600/50 R 22.5	159 E	882	Alliance	20.00 x 22.5	10/281/335	A3	-50	611
59911786					20.00 x 22.5	10/281/335	A3	0	611
59913532	600/50 R 22.5	166 F	390	Alliance	20.00 x 22.5	10/281/335	M22	0	585
59913563	600/50 R 22.5	167 D	380 Industrial HD	Alliance	20.00 x 22.5	10/281/335	A3	-50	611
59913562					20.00 x 22.5	10/281/335	A3	0	611
59915921	600/50 R 22.5	174 A8 / 171 B	390 Industrial HD	Alliance	20.00 x 22.5	10/281/335	A3	-50	605
59915920					20.00 x 22.5	10/281/335	A3	0	605
59917421	600/50 R 22.5	170 A8 / 159 D	FL 630 Ultra	BKT	20.00 x 22.5	8/221/275	A3	-50	611
59917425					20.00 x 22.5	10/281/335	A3	-50	611
59917423					20.00 x 22.5	10/281/335	A3	0	611
59917453	600/50 R 22.5	170 A8 / 159 D	FL 639	BKT	20.00 x 22.5	10/281/335	A3	-50	611
59917452					20.00 x 22.5	10/281/335	A3	0	611
59917446	600/50 R 22.5	159 D / 156 E	Ridemax FL 693 M	BKT	20.00 x 22.5	10/281/335	A3	-50	611
59917445					20.00 x 22.5	10/281/335	A3	0	611
59914409	600/50 R 22.5	159 D	Country King	Nokian	20.00 x 22.5	10/281/335	A3	-50	600
59914408					20.00 x 22.5	10/281/335	A3	0	600
59920610	600/55 R 22.5	162 E	380	Alliance	20.00 x 22.5	8/221/275	A2	0	600
59920618					20.00 x 22.5	10/281/335	A3	-50	600
59920616					20.00 x 22.5	10/281/335	A3	0	600
59917486	600/55 R 22.5	162 D	FL 630 Super	BKT	20.00 x 22.5	8/221/275	A2	0	595
59917489					20.00 x 22.5	10/281/335	A3	-50	595
59917488					20.00 x 22.5	10/281/335	A3	0	595

Alle Räder in TL Ausführung Standardlackierung für alle Felgen ist silber

HD = Heavy Duty

Alles auf einen Blick:

Außen ø in mm	stat. Halbmesser in mm	Abrollumfang in mm	Tragfähigkeit kpl. Rad in kg	km/h	Luftdruck in bar
1.244	557	3.764	4625	65	4,00
1.244	557	3.764	4625	65	4,00
1.326	588	4.030	5300	65	4,00
1.326	588	4.030	5300	65	4,00
1.315	580	4.040	5300	65	4,00
1.315	580	4.040	5300	65	4,00
1.326	572	4.031	5300	65	4,00
1.326	572	4.031	5300/4875	65/70	4,00
1.300	586	3.977	5300	65	4,00
1.300	586	3.977	5300	65	4,00
1.172	532	3.470	4375	65	4,00
1.171	531	3.605	4375	70	4,00
1.171	531	3.605	4375	70	4,00
1.172	527,5	3.473	4375	70	4,00
1.172	527,5	3.473	4375	70	4,00
1.180	539	3.510	5300	80	6,00
1.172	527	3.588	5450	65	5,00
1.172	527	3.588	5310	65	5,00
1.168	527	3.450	6700/6150	40/50	6,50
1.168	527	3.450	6700/6150	40/50	6,50
1.172	518	3.533	6000/4375	40/65	4,00
1.172	518	3.533	6000/4375	40/65	4,00
1.172	518	3.533	6000/4375	40/65	4,00
1.172	521	3.592	6000/4375	40/65	4,00
1.172	521	3.592	6000/4375	40/65	4,00
1.172	516	3.574	4375/4000	65/70	4,00
1.172	516	3.574	4375/4000	65/70	4,00
1.172	533	3.575	4375	65	4,00
1.172	533	3.575	4375	65	4,00
1.245	562	3.807	4750	70	4,00
1.245	562	3.807	4750	70	4,00
1.245	562	3.807	4750	70	4,00
1.232	560	3.757	4750	65	4,00
1.232	560	3.757	4750	65	4,00
1.232	560	3.757	4750	65	4,00



Alliance 380 /
380 Industrial HD

Alliance 390 /
390 Industrial HD

Alliance 882

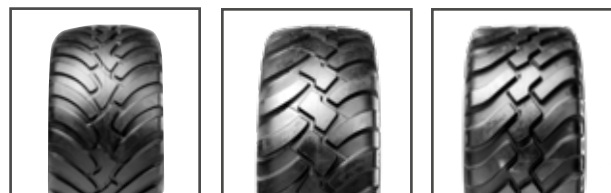

Alliance 885

BKT FL 630 Super

BKT FL 630 Ultra



BKT FL 639

BKT Ridemax
FL 693 M

Nokian Country King

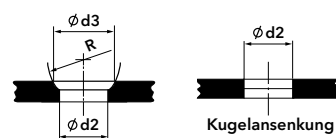

A2/A3

M22

Maße für Kugelansenkung

Bezeichnung	d2	d3	R	Bolzen- gewinde
A2	21,5	27	16	M18x1,5
A3	27	32	18	M22x1,5/M20x1,5
B3	27	32	18	M22x1,5/M20x1,5
M22	26	-	-	M22x1,5



Flotationräder Radial







Preise und Bestände finden Sie unter www.bohnenkamp.de/shop

Artikel-Nr.	Größe	Last-/ Speed-Index Reifen	Profil	Marke	Felge	Anschluss	Bolzenloch- ausführung	Einpress- tiefe	Breite in mm
59915512	620/40 R 22.5	148 D	Flotmaster 381	Alliance	20.00 x 22.5	8/221/275	A2	0	612
59915516					20.00 x 22.5	10/281/335	A3	-50	612
59915515					20.00 x 22.5	10/281/335	A3	0	612
59915535	620/40 R 22.5	154 D	Flotmaster 381	Alliance	20.00 x 22.5	8/221/275	A3	-50	612
59915528					20.00 x 22.5	8/221/275	A2	0	612
59915530					20.00 x 22.5	10/281/335	A3	-50	612
59915527					20.00 x 22.5	10/281/335	A3	0	612
59915514	620/40 R 22.5	155 D	380	Alliance	20.00 x 22.5	10/281/335	B3	-50	620
59915513					20.00 x 22.5	10/281/335	A3	0	620
59917468	620/40 R 22.5	154 D	FL 635	BKT	20.00 x 22.5	10/281/335	A3	-50	625
59917467					20.00 x 22.5	10/281/335	A3	0	625
59915533	620/50 R 22.5	161 D	Flotmaster 381	Alliance	20.00 x 22.5	10/281/335	A3	0	600
59915629	650/50 R 22.5	163 D	885	Alliance	20.00 x 22.5	8/221/275	A2	0	650
59915624					20.00 x 22.5	10/281/335	A3	-50	650
59915623					20.00 x 22.5	10/281/335	A3	0	650
59915622	650/50 R 22.5	163 E	380	Alliance	20.00 x 22.5	8/221/275	A3	-50	650
59915620					20.00 x 22.5	8/221/275	A2	0	650
59915628					20.00 x 22.5	10/281/335	A3	-100	650
59915627					20.00 x 22.5	10/281/335	A3	-50	650
59915626					20.00 x 22.5	10/281/335	A3	0	650
59917457	650/50 R 22.5	163 D / 160 E	Ridemax FL 693 M	BKT	20.00 x 22.5	8/221/275	A2	-50	645
59917456					20.00 x 22.5	8/221/275	A2	0	645
59917455					20.00 x 22.5	10/281/335	A3	-50	645
59917454					20.00 x 22.5	10/281/335	A3	0	645
59914411	650/50 R 22.5	163 D	Country King	Nokian	20.00 x 22.5	10/281/335	A3	-50	645
59914410					20.00 x 22.5	10/281/335	A3	0	645
59915151	650/55 R 22.5	167 D	FL 635	BKT	20.00 x 22.5	10/281/335	A3	-50	645
59915150					20.00 x 22.5	10/281/335	A3	0	645
59917497	710/35 R 22.5	157 D / 154 E	Ridemax FL 693 M	BKT	24.00 x 22.5	10/281/335	A3	-50	712
59917495					24.00 x 22.5	10/281/335	A3	0	712
59914413	710/35 R 22.5	157 D	Country King	Nokian	24.00 x 22.5	10/281/335	A3	-50	712
59914412					24.00 x 22.5	10/281/335	A3	0	712
10000743	710/40 R 22.5	162 D	Flotmaster 381	Alliance	24.00 x 22.5	8/221/275	A3	0	702
59915909					24.00 x 22.5	10/281/335	A3	-50	702
59915908					24.00 x 22.5	10/281/335	A3	0	702
59917476	710/40 R 22.5	172 A8 / 161 D	FL 630 Ultra	BKT	24.00 x 22.5	10/281/335	A3	-50	727
59917475					24.00 x 22.5	10/281/335	A3	0	727

Alle Räder in TL Ausführung Standardlackierung für alle Felgen ist silber

HD = Heavy Duty

Alles auf einen Blick:

 Außen ϕ in mm	 stat. Halbmesser in mm	 Abrollumfang in mm	 Tragfähigkeit kpl. Rad in kg	 km/h	 Luftdruck in bar
1.080	486	3.295	3150	65	3,20
1.080	486	3.295	3150	65	3,20
1.080	486	3.295	3150	65	3,20
1.080	486	3.278	3750	65	4,00
1.080	486	3.278	3750	65	4,00
1.080	486	3.278	3750	65	4,00
1.080	486	3.278	3750	65	4,00
1.072	488	3.352	3875	65	4,00
1.072	488	3.352	3875	65	4,00
1.068	470	3.249	3750	65	4,00
1.068	470	3.249	3750	65	4,00
1.170	520	3.601	4625	65	4,00
1.235	554	3.630	4875	65	4,00
1.235	554	3.630	4875	65	4,00
1.235	554	3.630	4875	65	4,00
1.235	554	3.798	4875	70	4,00
1.235	554	3.798	4875	70	4,00
1.235	554	3.798	4875	70	4,00
1.235	554	3.798	4875	70	4,00
1.235	554	3.798	4875	70	4,00
1.222	535	3.715	4875/4500	65/70	4,00
1.222	535	3.715	4875/4500	65/70	4,00
1.222	535	3.715	4875/4500	65/70	4,00
1.222	535	3.715	4875/4500	65/70	4,00
1.237	564	3.789	4875	65	4,00
1.237	564	3.789	4875	65	4,00
1.287	568	3.901	5450	65	4,00
1.287	568	3.901	5310	65	4,00
1.070	482	3.254	4125/3750	65/70	4,00
1.070	482	3.254	4125/3750	65/70	4,00
1.069	484	3.248	4125	65	4,00
1.069	484	3.248	4125	65	4,00
1.161	521	3.582	4750	65	4,00
1.161	521	3.582	4750	65	4,00
1.161	521	3.582	4750	65	4,00
1.140	514	3.490	6300/4625	40/65	4,00
1.140	514	3.490	6300/4625	40/65	4,00

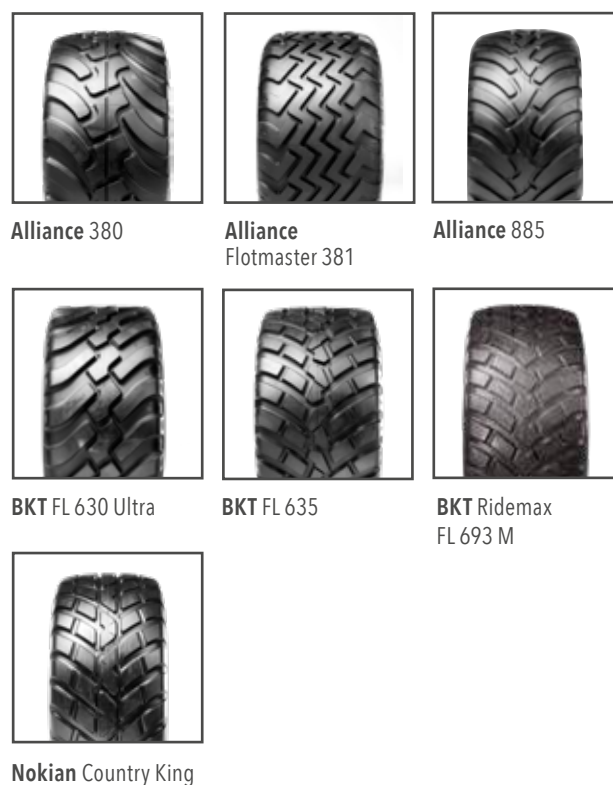

Nokian Country King

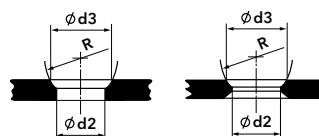

A2/A3 B3

Maße für Kugelansenkung

Bezeichnung	d2	d3	R	Bolzen- gewinde
A2	21,5	27	16	M18x1,5
A3	27	32	18	M22x1,5/M20x1,5
B3	27	32	18	M22x1,5/M20x1,5

Implement-/
Flotationräder



Flotationräder Radial







Preise und Bestände finden Sie unter www.bohnenkamp.de/shop

Artikel-Nr.	Größe	Last-/ Speed-Index Reifen	Profil	Marke	Felge	Anschluss	Bolzenloch- ausführung	Einpress- tiefe	Breite in mm
59917482	710/40 R 22.5	161 D	FL 635	BKT	24.00 x 22.5	10/281/335	A3	-50	727
59917481					24.00 x 22.5	10/281/335	A3	0	727
59915656	710/45 R 22.5	165 D	380	Alliance	24.00 x 22.5	10/281/335	A3	-50	727
59915655					24.00 x 22.5	10/281/335	A3	0	727
59915668	710/45 R 22.5	165 D	885	Alliance	24.00 x 22.5	10/281/335	A3	-50	725
59915669					24.00 x 22.5	10/281/335	A3	0	725
59915157	710/45 R 22.5	165 D	Ridemax FL 693 M	BKT	24.00 x 22.5	10/281/335	A3	-50	706
59915156					24.00 x 22.5	10/281/335	A3	0	706
59914415	710/45 R 22.5	165 D	Country King	Nokian	24.00 x 22.5	10/281/335	A3	-50	727
59914414					24.00 x 22.5	10/281/335	A3	0	727
59915611	750/45 R 22.5	166 E	380	Alliance	24.00 x 22.5	10/281/335	A3	-50	750
59915610					24.00 x 22.5	10/281/335	A3	0	750
59915693	750/45 R 22.5	177 D / 174 E	380 Industrial HD	Alliance	24.00 x 22.5	10/281/335	A3	-50	745
59915692					24.00 x 22.5	10/281/335	A3	0	745
59915670	620/75 R 26	174 D	390	Alliance	DW 20 B x 26*	10/281/335	B3	0	620
59914225	28 LR 26	176 A8 / 173 B	390	Alliance	DW 25 B x 26	10/281/335	B3	-50	727
59914220					DW 25 B x 26	10/281/335	A3	0	727
59915181	28 LR 26	176 A8 / 173 B	Ridemax FL 690	BKT	DW 25 B x 26	10/281/335	B3	-50	719
59915180					DW 25 B x 26	10/281/335	A3	0	719
59915919	600/55 R 26.5	165 D	390	Alliance	20.00 x 26.5	10/281/335	A3	-50	624
59915918					20.00 x 26.5	10/281/335	A3	0	624
59915761	600/55 R 26.5	165 D	882	Alliance	20.00 x 26.5	8/221/275	A2	-50	611
59915760					20.00 x 26.5	8/221/275	A2	0	611
59915763					20.00 x 26.5	10/281/335	A3	-50	611
59915762					20.00 x 26.5	10/281/335	A3	0	611
59915755	600/55 R 26.5	165 D	885	Alliance	20.00 x 26.5	10/281/335	A3	-50	625
59915754					20.00 x 26.5	10/281/335	A3	0	625
59915750					20.00 x 26.5	10/281/335	A3	+50	625
59915752	600/55 R 26.5	165 E	380	Alliance	20.00 x 26.5	10/281/335	A3	-50	625
59915751					20.00 x 26.5	10/281/335	A3	0	625
59915757	VF 600/55 R 26.5	167 D	Agriflex 389 +	Alliance	20.00 x 26.5	8/221/275	A2	-50	629
59915756					20.00 x 26.5	8/221/275	A2	0	629
59915759					20.00 x 26.5	10/281/335	A3	-50	629
59915758					20.00 x 26.5	10/281/335	A3	0	629
59915913	600/55 R 26.5	177 D	380 Industrial HD	Alliance	20.00 x 26.5	10/281/335	A3	-50	624
59915912					20.00 x 26.5	10/281/335	A3	0	624

* = verstärkt

Alle Räder in TL Ausführung Standardlackierung für alle Felgen ist silber
HD = Heavy Duty

Alles auf einen Blick:

 Außen ϕ in mm	 stat. Halbmesser in mm	 Abrollumfang in mm	 Tragfähigkeit kpl. Rad in kg	 km/h	 Luftdruck in bar
1.140	510	3.467	4625	65	4,00
1.140	510	3.467	4625	65	4,00
1.210	534	3.683	5150	65	4,00
1.210	534	3.683	5150	65	4,00
1.210	535	3.675	5150	65	4,00
1.210	535	3.675	5150	65	4,00
1.212	542	3.658	5150	65	4,00
1.212	542	3.658	5150	65	4,00
1.212	545	3.695	5150	65	4,00
1.212	545	3.695	5150	65	4,00
1.245	562	3.843	5300	70	4,00
1.245	562	3.843	5300	70	4,00
1.250	557	3.828	6640/6360	65/70	5,00
1.250	557	3.828	6640/6360	65/70	5,00
1.590	707	4.721	5400	40	4,00
1.542	688	4.520	7100/6500	40/50	2,80
1.542	688	4.520	7100/6500	40/50	2,80
1.590	695	4.745	7100/6500	40/50	2,80
1.590	695	4.745	7100/6500	40/50	2,80
1.355	613	4.119	5150	65	4,00
1.355	613	4.119	5150	65	4,00
1.333	604	4.043	5150	65	4,00
1.333	604	4.043	5150	65	4,00
1.333	604	4.043	5150	65	4,00
1.333	604	4.043	5150	65	4,00
1.345	610	3.980	5150	65	4,00
1.345	610	3.980	5150	65	4,00
1.345	610	3.980	5150	65	4,00
1.346	609	4.160	5150	70	4,00
1.346	609	4.160	5150	70	4,00
1.348	587	4.064	5450	65	2,80
1.348	587	4.064	5450	65	2,80
1.348	587	4.064	5450	65	2,80
1.348	587	4.064	5450	65	2,80
1.350	606	4.136	7300	65	5,00
1.350	606	4.136	7300	65	5,00



Implement-/
Flotationräder

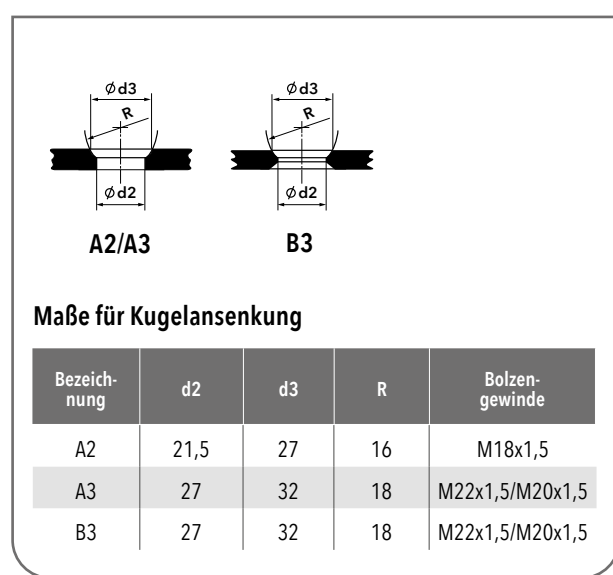



Flotationräder Radial

Preise und Bestände finden Sie unter www.bohnenkamp.de/shop

Artikel-Nr.	Größe	Last-/ Speed-Index Reifen	Profil	Marke	Felge	Anschluss	Bolzenloch- ausführung	Einpress- tiefe	Breite in mm
10001167	600/55 R 26.5	173 D	590	Alliance	20.00 x 26.5	10/281/335	B3	-50	611
10001168									0
59917541	600/55 R 26.5	176 A8 / 165 D	FL 630 Ultra	BKT	20.00 x 26.5	10/281/335	A3	-50	611
59917540									0
59917539	600/55 R 26.5	165 D	Ridemax FL 693 M	BKT	20.00 x 26.5	10/281/335	A3	-50	611
59917538									0
59917516	VF 600/55 R 26.5	167 D	V-Flexa	BKT	20.00 x 26.5	10/281/335	B3	-50	615
59917514									0
59917523	600/55 R 26.5	177 D	FL 630 Super	BKT	20.00 x 26.5	8/221/275	A2	-50	611
59917521					20.00 x 26.5	8/221/275	A2	0	611
59917533					20.00 x 26.5	10/281/335	A3	-50	611
59917531					20.00 x 26.5	10/281/335	A3	0	611
59917503	600/55 R 26.5	177 D	Ridemax FL 693 M	BKT	20.00 x 26.5	10/281/335	A3	-50	611
59917504									0
59915961	620/55 R 26.5	166 D	Flotmaster 381	Alliance	20.00 x 26.5	10/281/335	A3	-50	612
59915960									0
59914417	620/60 R 26.5	169 D	Country King	Nokian	20.00 x 26.5	10/281/335	A3	-50	625
59914416									0
59915964	650/55 R 26.5	170 D / 167 E	380	Alliance	20.00 x 26.5	8/221/275	A2	0	645
59915966					20.00 x 26.5	10/281/335	A3	-50	645
59915968					20.00 x 26.5	10/281/335	A3	0	645
59913622	650/55 R 26.5	170 D	390	Alliance	20.00 x 26.5	10/281/335	A3	-50	660
59913620									0
59915683	650/55 R 26.5	170 D	882	Alliance	20.00 x 26.5	10/281/335	A3	-50	645
59915684									0
59915977	650/55 R 26.5	170 D	885	Alliance	20.00 x 26.5	10/281/335	A3	-50	648
59915976									0
59915981	VF 650/55 R 26.5	171 D	Agriflex 389 +	Alliance	20.00 x 26.5	8/221/275	A2	-50	650
59915979					20.00 x 26.5	8/221/275	A2	0	650
59915983					20.00 x 26.5	10/281/335	A3	-50	650
59915982					20.00 x 26.5	10/281/335	A3	0	650
59915972	650/55 R 26.5	178 D	380 Industrial HD	Alliance	20.00 x 26.5	10/281/335	A3	-50	641
59915971									0
59915974	650/55 R 26.5	178 D	390 Industrial HD	Alliance	20.00 x 26.5	10/281/335	A3	-50	663
59915973									0
10001165	650/55 R 26.5	177 D	590	Alliance	20.00 x 26.5	10/281/335	B3	-50	650
10001166									0

Alle Räder in TL Ausführung Standardlackierung für alle Felgen ist silber

HD = Heavy Duty

Alles auf einen Blick:

Außen ϕ in mm	stat. Halbmesser in mm	Abrollumfang in mm	Tragfähigkeit kpl. Rad in kg	km/h	Luftdruck in bar
1.333	611,7	4.071	6500	65	6,00
1.333	611,7	4.071	6500	65	6,00
1.333	579	4.070	7100/5150	40/65	4,00
1.333	579	4.070	7100/5150	40/65	4,00
1.333	586	4.051	5150	65	4,00
1.333	586	4.051	5150	65	4,00
1.342	580	3.986	5450	65	2,80
1.342	580	3.986	5450	65	2,80
1.333	604	4.104	6500	65	6,00
1.333	604	4.104	6500	65	6,00
1.333	604	4.104	7300	65	6,00
1.333	604	4.104	7300	65	6,00
1.333	584	4.077	7300	65	6,00
1.333	584	4.077	7300	65	6,00
1.356	608	4.147	5300	65	4,00
1.356	608	4.147	5300	65	4,00
1.400	639	4.291	5800	65	4,00
1.400	639	4.291	5800	65	4,00
1.360	618	4.175	6000/5450	65/70	4,00
1.360	618	4.175	6000/5450	65/70	4,00
1.360	618	4.175	6000/5450	65/70	4,00
1.395	629	4.266	6000	65	4,00
1.395	629	4.266	6000	65	4,00
1.389	621	4.227	6000	65	4,00
1.389	621	4.227	6000	65	4,00
1.380	630	4.080	6000	65	4,00
1.380	630	4.080	6000	65	4,00
1.384	600	4.173	6150	65	2,80
1.384	600	4.173	6150	65	2,80
1.384	600	4.173	6150	65	2,80
1.384	600	4.173	6150	65	2,80
1.367	614	4.020	7500	65	5,00
1.367	614	4.020	7500	65	5,00
1.394	635	4.266	7500	65	5,00
1.394	635	4.266	7500	65	5,00
1.390	635,4	4.253	7300	65	6,00
1.390	635,4	4.253	7300	65	7,00

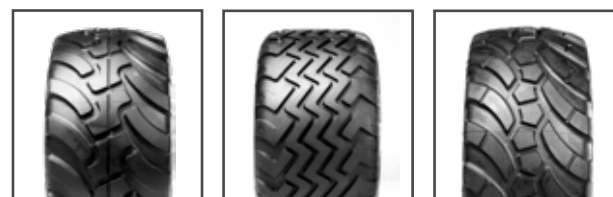

Alliance 380 / 380 Industrial HD **Alliance Flotmaster 381** **Alliance Agriflex 389 +**

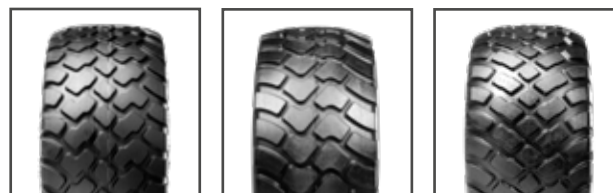

Alliance 390 / 390 Industrial HD **Alliance 590** **Alliance 882**



Alliance 885 **BKT FL 630 Super** **BKT FL 630 Ultra**



BKT Ridemax FL 693 M **BKT V-Flexa** **Nokian Country King**

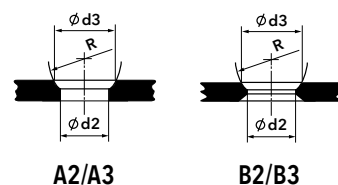

Maße für Kugelansenkung

Bezeichnung	d2	d3	R	Bolzen-gewinde
A2	21,5	27	16	M18x1,5
A3	27	32	18	M22x1,5/M20x1,5
B2	21,5	27	16	M18x1,5
B3	27	32	18	M22x1,5/M20x1,5



Flotationräder Radial

Preise und Bestände finden Sie unter www.bohnenkamp.de/shop

Artikel-Nr.	Größe	Last-/ Speed-Index Reifen	Profil	Marke	Felge	Anschluss	Bolzenloch- ausführung	Einpress- tiefe	Breite in mm
59917549	650/55 R 26.5	180 A8 / 169 D	FL 630 Ultra	BKT	20.00 x 26.5	10/281/335	A3	-50	645
59917548					20.00 x 26.5	10/281/335	A3	0	645
59917555	650/55 R 26.5	169 D	FL 630 Super	BKT	20.00 x 26.5	10/281/335	A3	-50	645
59917550					20.00 x 26.5	10/281/335	A3	0	645
59917558					20.00 x 26.5	10/281/335	B3	+30	645
59917448	650/55 R 26.5	169 D	Ridemax FL 693 M	BKT	20.00 x 26.5	10/281/335	A3	-50	645
59917447					20.00 x 26.5	10/281/335	A3	0	645
59917594	650/55 R 26.5	178 D	FL 630 Super	BKT	20.00 x 26.5	10/281/335	A3	-50	645
59917591					20.00 x 26.5	10/281/335	A3	0	645
59917443	650/55 R 26.5	178 D	Ridemax FL 693 M	BKT	20.00 x 26.5	8/221/275	A2	-50	645
59917431					20.00 x 26.5	8/221/275	A2	0	645
59917429					20.00 x 26.5	10/281/335	A3	-50	645
59917428					20.00 x 26.5	10/281/335	A3	0	645
59917974	650/55 R 26.5	178 D	FL 695	BKT	20.00 x 26.5	10/281/335	B3	-50	630
59917976					20.00 x 26.5	10/281/335	B3	0	630
59915980	650/60 R 26.5	173 D	380	Alliance	20.00 x 26.5	10/281/335	A3	-50	660
59915970					20.00 x 26.5	10/281/335	A3	0	660
59917547	650/65 R 26.5	174 D	FL 630 Super	BKT	20.00 x 26.5	10/281/335	A3	-50	645
59917546					20.00 x 26.5	10/281/335	A3	0	645
10000220	650/65 R 26.5	174 D	885	Alliance	20.00 x 26.5	10/281/335	B3	0	645
59915991	710/50 R 26.5	170 D	380	Alliance	24.00 x 26.5	10/281/335	A3	-50	732
59915990					24.00 x 26.5	10/281/335	A3	0	732
59915958	710/50 R 26.5	170 D	Flotmaster 381	Alliance	24.00 x 26.5	10/281/335	A3	-50	710
59915957					24.00 x 26.5	10/281/335	A3	0	710
59917579	710/50 R 26.5	170 D	885	Alliance	24.00 x 26.5	10/281/335	A3	-50	732
59917576					24.00 x 26.5	10/281/335	A3	0	732
59917573	710/50 R 26.5	172 D	390	Alliance	24.00 x 26.5	10/281/335	A3	-100	730
59913612					24.00 x 26.5	10/281/335	A3	-50	730
59913610					24.00 x 26.5	10/281/335	A3	0	730
59911791	710/50 R 26.5	172 D	882	Alliance	24.00 x 26.5	10/281/335	A3	-50	727
59911790					24.00 x 26.5	10/281/335	A3	0	727
59915997	VF 710/50 R 26.5	173 D	Agriflex 389 +	Alliance	24.00 x 26.5	8/221/275	A2	-50	732
59915996					24.00 x 26.5	8/221/275	A2	0	732
59915995					24.00 x 26.5	10/281/335	A3	-50	732
59915994					24.00 x 26.5	10/281/335	A3	0	732

Alle Räder in TL Ausführung Standardlackierung für alle Felgen ist silber
 HD = Heavy Duty

* = schwarz RAL 9005

Alles auf einen Blick:

Außen ϕ in mm	stat. Halbmesser in mm	Abrollumfang in mm	Tragfähigkeit kpl. Rad in kg	km/h	Luftdruck in bar
1.389	600	4.207	8000/5800	40/65	4,00
1.389	600	4.207	8000/5800	40/65	4,00
1.389	627	4.258	5800	65	4,00
1.389	627	4.258	5800	65	4,00
1.389	627	4.258	5800	65	4,00
1.389	608	4.216	5800	65	4,00
1.389	608	4.216	5800	65	4,00
1.389	628	4.292	7500	65	6,00
1.389	628	4.292	7500	65	6,00
1.389	609	4.250	6500	65	6,00
1.389	609	4.250	6500	65	6,00
1.389	609	4.250	7500	65	6,00
1.389	609	4.250	7500	65	6,00
1.390		4.242	7500	65	6,00
1.390		4.242	7500	65	6,00
1.450	655	4.280	6500	65	4,00
1.450	655	4.280	6500	65	4,00
1.519	684	4.653	6700	65	4,00
1.519	684	4.653	6700	65	4,00
1.519	670	4.580	6700	65	4,00
1.400	630	4.290	6000	65	4,00
1.400	630	4.290	6000	65	4,00
1.360	610	4.171	6000	65	4,00
1.360	610	4.171	6000	65	4,00
1.400	629	4.290	6000	65	4,00
1.400	629	4.290	6000	65	4,00
1.390	627	4.100	6300	65	4,00
1.390	627	4.100	6300	65	4,00
1.390	627	4.100	6300	65	4,00
1.383	623	4.219	6300	65	4,00
1.383	623	4.219	6300	65	4,00
1.400	602	4.271	6300	65	2,80
1.400	602	4.271	6300	65	2,80
1.400	602	4.271	6500	65	2,80
1.400	602	4.271	6500	65	2,80



Alliance 380



Alliance
Flotmaster 381

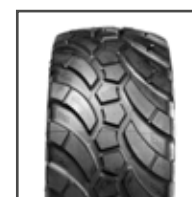

Alliance Agriflex
389 +



Alliance 390



Alliance 882



Alliance 885

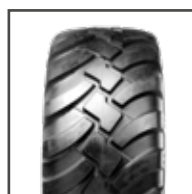

BKT FL 630 Super



BKT FL 630 Ultra



BKT FL 695



BKT Ridemax FL 693 M

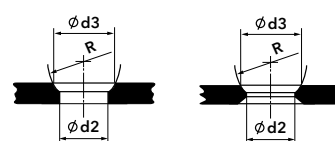

A2/A3

B2/B3

Maße für Kugelansenkung

Bezeichnung	d2	d3	R	Bolzen- gewinde
A2	21,5	27	16	M18x1,5
A3	27	32	18	M22x1,5/M20x1,5
B2	21,5	27	16	M18x1,5
B3	27	32	18	M22x1,5/M20x1,5



Flotationräder Radial

Preise und Bestände finden Sie unter www.bohnenkamp.de/shop

Artikel-Nr.	Größe	Last-/ Speed-Index Reifen	Profil	Marke	Felge	Anschluss	Bolzenloch- ausführung	Einpress- tiefe	Breite in mm
59917553	710/50 R 26.5	181 A8 / 170 D	FL 630 Ultra	BKT	24.00 x 26.5	10/281/335	A3	-50	727
59917552					24.00 x 26.5	10/281/335	A3	0	727
59917459	710/50 R 26.5	170 D	Ridemax FL 693 M	BKT	24.00 x 26.5	10/281/335	A3	-50	727
59917449					24.00 x 26.5	10/281/335	A3	0	727
59914421	710/50 R 26.5	170 D	Country King	Nokian	24.00 x 26.5	10/281/335	A3	-50	727
59914420					24.00 x 26.5	10/281/335	A3	0	727
59915860	750/45 R 26.5	170 D	885	Alliance	24.00 x 26.5	10/281/335	A3	-50	740
59915859					24.00 x 26.5	10/281/335	A3	0	740
59915863	VF 750/45 R 26.5	172 D	Agriflex 389 +	Alliance	24.00 x 26.5	8/221/275	A2	-50	754
59915862					24.00 x 26.5	8/221/275	A2	0	754
59915874					24.00 x 26.5	10/281/335	A3	-50	754
59915873					24.00 x 26.5	10/281/335	A3	0	754
59915858	750/45 R 26.5	173 D / 170 E	380	Alliance	24.00 x 26.5	10/281/335	A3	-100	750
59915856					24.00 x 26.5	10/281/335	A3	-50	750
59915854					24.00 x 26.5	10/281/335	A3	0	750
59913834	750/45 R 26.5	170 D	FL 630 Super	BKT	24.00 x 26.5	10/281/335	A3	-100	754
59913833					24.00 x 26.5	10/281/335	A3	-50	754
59913832					24.00 x 26.5	10/281/335	A3	0	754
59917581	750/60 R 26.5	180 D	FL 630 Super	BKT	24.00 x 26.5	10/281/335	A3	-50	754
59917580					24.00 x 26.5	10/281/335	A3	0	754
59916025	800/45 R 26.5	174 D	Flotmaster 381	Alliance	28.00 x 26.5	10/281/335	A3	-50	801
59916023					28.00 x 26.5	10/281/335	A3	0	801
59916017	800/45 R 26.5	174 D	885	Alliance	28.00 x 26.5	10/281/335	A3	-100	800
59916020					28.00 x 26.5	10/281/335	A3	-50	800
59916019					28.00 x 26.5	10/281/335	A3	0	800
59913642	800/45 R 26.5	177 D	390	Alliance	28.00 x 26.5	10/281/335	A3	-50	810
59913640					28.00 x 26.5	10/281/335	A3	0	810
59917622	800/45 R 26.5	184 A8 / 174 D	FL 630 Ultra	BKT	28.00 x 26.5	10/281/335	A3	-100	828
59917621					28.00 x 26.5	10/281/335	A3	-50	828
59917620					28.00 x 26.5	10/281/335	A3	0	828
59917612	800/45 R 26.5	174 D	Country King	Nokian	28.00 x 26.5	10/281/335	A3	-50	815
59917611					28.00 x 26.5	10/281/335	A3	0	815
59917438	600/60 R 30.5	173 D	390	Alliance	20.00 x 30.5	10/281/335	A3	-50	635
59917437					20.00 x 30.5	10/281/335	A3	0	635
10001164	600/60 R 30.5	173 D	590	Alliance	20.00 x 30.5	10/281/335	A3	0	611

Alle Räder in TL Ausführung Standardlackierung für alle Felgen ist silber
HD = Heavy Duty

Alles auf einen Blick:

Außen ϕ in mm	stat. Halbmesser in mm	Abrollumfang in mm	Tragfähigkeit kpl. Rad in kg	km/h	Luftdruck in bar
1.383	599	4.208	8250/6000	40/65	4,00
1.383	599	4.208	8250/6000	40/65	4,00
1.383	606	4.217	6000	65	4,00
1.383	606	4.217	6000	65	4,00
1.405	646	4.304	6000	65	4,00
1.405	646	4.304	6000	65	4,00
1.360	618	4.138	6000	65	4,00
1.360	618	4.138	6000	65	4,00
1.360	589	4.086	6300	65	2,80
1.360	589	4.086	6300	65	2,80
1.360	589	4.086	6300	65	2,80
1.360	589	4.086	6300	65	2,80
1.360	608	4.113	6500/6000	65/70	4,00
1.360	608	4.113	6500/6000	65/70	4,00
1.360	608	4.113	6500/6000	65/70	4,00
1.349	606	4.147	6000	65	4,00
1.349	606	4.147	6000	65	4,00
1.349	606	4.147	6000	65	4,00
1.574	694	4.800	7500	65	4,00
1.574	694	4.800	7500	65	4,00
1.374	613	4.252	6700	65	4,00
1.374	613	4.252	6700	65	4,00
1.390	623	4.216	6700	65	4,00
1.390	623	4.216	6700	65	4,00
1.390	623	4.216	6700	65	4,00
1.395	627,1	4.110	7300	65	4,00
1.395	627,1	4.110	7300	65	4,00
1.393	618	4.238	9000/6700	40/65	4,00
1.393	618	4.238	9000/6700	40/65	4,00
1.393	618	4.238	9000/6700	40/65	4,00
1.396	622	4.240	6700	65	4,00
1.396	622	4.240	6700	65	4,00
1.505	683	4.460	6500	65	4,00
1.505	683	4.460	6500	65	4,00
1.495	684,1	4.542	6500	65	5,00

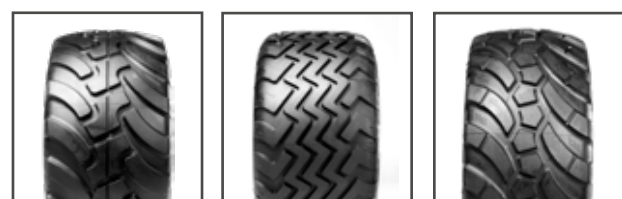

Alliance 380

Alliance Flotmaster 381

Alliance Agriflex 389 +

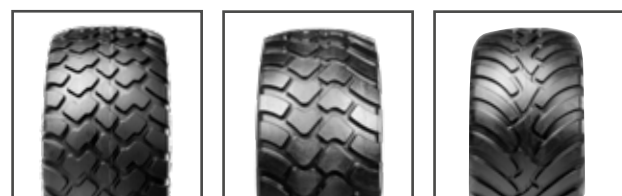

Alliance 390

Alliance 590

Alliance 885

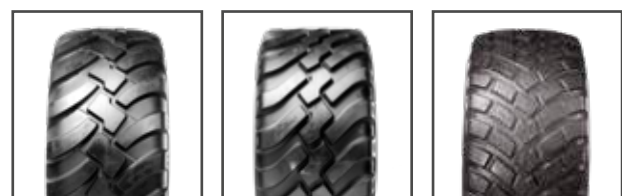

BKT FL 630 Super

BKT FL 630 Ultra

BKT Ridemax FL 693 M

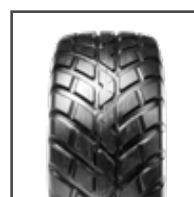

Nokian Country King

Implement-/
Flotationräder

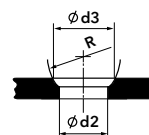

A3

Maße für Kugellansenkung

Bezeichnung	d2	d3	R	Bolzen- gewinde
A3	27	32	18	M22x1,5/M20x1,5



Flotationräder Radial

Preise und Bestände finden Sie unter www.bohnenkamp.de/shop

Artikel-Nr.	Größe	Last-/ Speed-Index Reifen	Profil	Marke	Felge	Anschluss	Bolzenloch- ausführung	Einpress- tiefe	Breite in mm
59917922	650/65 R 30.5	176 D	380	Alliance	20.00 x 30.5	10/281/335	A3	-50	680
59917921					20.00 x 30.5	10/281/335	A3	0	680
59917929	650/65 R 30.5	176 D	FL 630 Super	BKT	20.00 x 30.5	10/281/335	A3	-50	645
59917928					20.00 x 30.5	10/281/335	A3	0	645
59911801	710/50 R 30.5	173 D	885	Alliance	24.00 x 30.5	10/281/335	A3	-50	733
59911800					24.00 x 30.5	10/281/335	A3	0	733
59917568	710/50 R 30.5	176 D	390	Alliance	24.00 x 30.5	10/281/335	A3	-50	727
59917567					24.00 x 30.5	10/281/335	A3	0	727
59917586	710/50 R 30.5	173 D	Ridemax FL 693 M	BKT	24.00 x 30.5	10/281/335	A3	-50	727
59917585					24.00 x 30.5	10/281/335	A3	0	727
59913874	750/60 R 30.5	181 D	380	Alliance	24.00 x 30.5	10/281/335	A3	-50	767
59913871					24.00 x 30.5	10/281/335	A3	0	767
59913862	750/60 R 30.5	181 D	390	Alliance	24.00 x 30.5	10/281/335	A3	-50	780
59913861					24.00 x 30.5	10/281/335	A3	0	780
59911796	750/60 R 30.5	181 D	882	Alliance	24.00 x 30.5	10/281/335	A3	-50	754
59911795					24.00 x 30.5	10/281/335	A3	0	754
59913885	750/60 R 30.5	181 D	885	Alliance	24.00 x 30.5	10/281/335	A3	-50	767
59913884					24.00 x 30.5	10/281/335	A3	0	767
59915868	VF 750/60 R 30.5	183 D	Agriflex 389 +	Alliance	24.00 x 30.5	10/281/335	A3	-100	780
59915867					24.00 x 30.5	10/281/335	A3	-50	780
59915866					24.00 x 30.5	10/281/335	A3	0	780
59915923	750/60 R 30.5	190 D	390 Industrial HD	Alliance	24.00 x 30.5	10/281/335	A3	-50	770
59915922					24.00 x 30.5	10/281/335	A3	0	770
59913845	750/60 R 30.5	181 D	FL 630 Super	BKT	24.00 x 30.5	10/281/335	A3	-50	754
59913844					24.00 x 30.5	10/281/335	A3	0	754
59913843	750/60 R 30.5	181 D	Ridemax FL 693 M	BKT	24.00 x 30.5	10/281/335	A3	-50	754
59913842					24.00 x 30.5	10/281/335	A3	0	754
59917961	750/60 R 30.5	181 D	Country King	Nokian	24.00 x 30.5	10/281/335	A3	-50	750
59917960					24.00 x 30.5	10/281/335	A3	0	750
59915871	800/45 R 30.5	176 D	885	Alliance	28.00 x 30.5	10/281/335	A3	-50	790
59915870					28.00 x 30.5	10/281/335	A3	0	790
59913856	850/50 R 30.5	182 D	390	Alliance	28.00 x 30.5	10/281/335	A3	0	882
59913882	850/50 R 30.5	182 D	Ridemax FL 693 M	BKT	28.00 x 30.5	10/281/335	A3	-50	862
59913881					28.00 x 30.5	10/281/335	A3	0	862

Alle Räder in TL Ausführung Standardlackierung für alle Felgen ist silber
 HD = Heavy Duty

Alles auf einen Blick:

Außen ϕ in mm	stat. Halbmesser in mm	Abrollumfang in mm	Tragfähigkeit kpl. Rad in kg	km/h	Luftdruck in bar
1.625	726	4.881	7100	65	4,00
1.625	726	4.881	7100	65	4,00
1.621	734	4.976	7100	65	4,00
1.621	734	4.976	7100	65	4,00
1.490	677	4.560	6500	65	4,00
1.490	677	4.560	6500	65	4,00
1.495	680	4.430	7100	65	4,00
1.495	680	4.430	7100	65	4,00
1.485	656	4.533	6500	65	4,00
1.485	656	4.533	6500	65	4,00
1.680	754	5.145	8250	65	4,00
1.680	754	5.145	8250	65	4,00
1.675	756	4.950	8250	65	4,00
1.675	756	4.950	8250	65	4,00
1.675	748	5.121	8250	65	4,00
1.675	748	5.121	8250	65	4,00
1.680	754	5.113	8250	65	4,00
1.680	754	5.113	8250	65	4,00
1.680	721	5.071	8250	65	2,80
1.680	721	5.071	8250	65	2,80
1.680	721	5.071	8250	65	2,80
1.685	751	5.136	8250	65	5,00
1.685	751	5.136	8250	65	5,00
1.675	746	5.115	8250	65	4,00
1.675	746	5.115	8250	65	4,00
1.675	728	5.092	8250	65	4,00
1.675	728	5.092	8250	65	4,00
1.680	757	5.144	8250	65	4,00
1.680	757	5.144	8250	65	4,00
1.495	670	4.597	7100	65	4,00
1.495	670	4.597	7100	65	4,00
1.653	742	4.860	8500	65	4,00
1.625	719	4.925	8500	65	4,00
1.625	719	4.925	8500	65	4,00



BKT Ridemax FL 693 M Nokian Country King

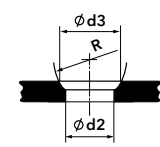

A3

Maße für Kugellansenkung

Bezeichnung	d2	d3	R	Bolzen- gewinde
A3	27	32	18	M22x1,5/M20x1,5

Implement-/
Flotationräder



Flotationräder Radial

Preise und Bestände finden Sie unter www.bohnenkamp.de/shop

Artikel-Nr.	Größe	Last-/ Speed-Index Reifen	Profil	Marke	Felge	Anschluss	Bolzenloch- ausführung	Einpress- tiefe	Breite in mm
59916230	30.5 LR 32	178 A8 / 175 B	360	Alliance	TW 27 B x 32	10/281/335	B3	0	775
59913930	30.5 LR 32	181 B	390	Alliance	TW 27 B x 32	10/281/335	B3	0	790
59914351	30.5 LR 32	181 B	Ridemax FL 690	BKT	TW 27 B x 32	10/281/335	B3	-50	790
59914350					TW 27 B x 32	10/281/335	B3	0	790
59913942	800/60 R 32	184 D / 181 E	390	Alliance	TW 27 B x 32	10/281/335	B3	-50	800
59913940					TW 27 B x 32	10/281/335	B3	0	800
59913949	VF 800/60 R 32	188 D	Agriflex 389 +	Alliance	TW 27 B x 32	10/281/335	B3	-50	800
59913948					TW 27 B x 32	10/281/335	B3	0	800
59914355	800/60 R 32	185 D	Ridemax FL 690	BKT	TW 27 B x 32	10/281/335	B3	-50	800
59914354					TW 27 B x 32	10/281/335	B3	0	800
59913953	800/65 R 32	181 A8 / 178 B	360	Alliance	TW 27 B x 32	10/281/335	B3	-50	800
59913952					TW 27 B x 32	10/281/335	B3	0	800
10000424	800/65 R 32	185 D	Ridemax FL 615	BKT	TW 27 B x 32	10/281/335	B3	-50	830
10000423					TW 27 B x 32	10/281/335	B3	0	830
10000420					TW 27 B x 32	10/281/335	B3	+30	830







Alle Räder in TL Ausführung Standardlackierung für alle Felgen ist silber



RUNDLÄUFER!

Wir montieren alle Flotation Radialreifen von Alliance und BKT rundlaufoptimiert

Alles auf einen Blick:

 Außen ϕ in mm	 stat. Halbmesser in mm	 Abrollumfang in mm	 Tragfähigkeit kpl. Rad in kg	 km/h	 Luftdruck in bar
1.820	809	5.319	7500/6900	40/50	3,10
1.800	805	5.431	9490	40	3,00
1.800	806	5.430	8250	50	3,00
1.800	806	5.430	9490	40	3,00
1.800	806	5.424	9000	65	4,00
1.800	806	5.424	12240	40	4,00
1.800	778	5.465	10000	65	2,80
1.800	778	5.465	10000	65	2,80
1.800	817	5.454	9250	65	4,00
1.800	817	5.454	12240	40	4,00
1.850	825	5.533	8250/7500	40/50	3,60
1.850	825	5.533	8250/7500	40/50	3,60
1.858	834	5.624	9250	65	3,60
1.858	834	5.624	9250	65	3,60
1.858	834	5.624	9250	65	3,60



Alliance 360

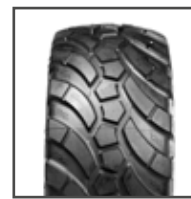

Alliance Agriflex
389 +



Alliance 390

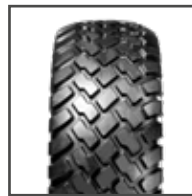

BKT Ridemax FL 690



BKT Ridemax FL 615

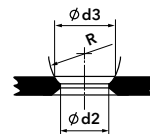

B3

Maße für Kugellansenkung

Bezeichnung	d2	d3	R	Bolzen- gewinde
A3	27	32	18	M22x1,5/M20x1,5





Flotationräder mit Anschluss für Reifendruckregelanlage

Preise und Bestände finden Sie unter www.bohnenkamp.de/shop

Artikel-Nr.	Größe	Last-/Speed-Index Reifen	Profil	Marke	Felge	Anschluss	Bolzenloch-ausführung	Einpress-tiefe	Breite in mm
59917577	710/50 R 30.5	176 D	390	Alliance	24.00 x 30.5	10/281/335	A3	0	727
59917588	710/50 R 30.5	173 D	Ridemax FL 693 M	BKT	24.00 x 30.5	107281/335	A3	0	727
59913864	750/60 R 30.5	181 D	390	Alliance	24.00 x 30.5	10/281/335	A3	0	780
59913886	750/60 R 30.5	181 D	885	Alliance	24.00 x 30.5	10/281/335	A3	0	767
59915869	VF 750/60 R 30.5	183 D	Agriflex 389 +	Alliance	24.00 x 30.5	10/281/335	A3	0	780
59913839	750/60 R 30.5	181 D	FL 630 Super	BKT	24.00 x 30.5	10/281/335	A3	0	754
59913848	750/60 R 30.5	181 D	Ridemax FL 693 M	BKT	24.00 x 30.5	10/281/335	A3	0	754

Alle Räder in TL Ausführung Standardlackierung für alle Felgen ist silber

Räder mit Reifendruckregelanlage

Die saubere Lösung für die Aus- und Umrüstung von Rädern mit Reifendruckregelanlagen

Vorteile:

- ⇒ Keine Verunreinigung der Anlage
- ⇒ Einfacher Anschluss des Rades an der Anlage
- ⇒ Keine zeitaufwendige Montage
- ⇒ Markterprobtes System









Montagesatz Reifendruckregelanlage



Auch bestellbar als Vorbereitung für die Reifendruckregelanlage

Alles auf einen Blick:

 Außen \varnothing in mm	 stat. Halbmesser in mm	 Abrollumfang in mm	 Tragfähigkeit kpl. Rad in kg	 km/h	 Luftdruck in bar
1495	680	4430	7100	65	4,00
1485	656	4533	6500	65	4,00
1675	756	4950	8250	65	4,00
1680	754	5113	8250	65	4,00
1680	721	5071	8250	65	2,80
1675	746	5115	8250	65	4,00
1675	728	5092	8250	65	4,00



Alliance Agriflex 389 +

Alliance 390

Alliance 885



BKT FL 630 Super



BKT Ridemax FL 693 M

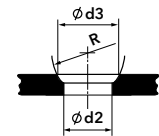

Maße für Kugellansenkung

A3

Bezeichnung	d2	d3	R	Bolzen- gewinde
A3	27	32	18	M22x1,5/M20x1,5

Keine zusätzlichen Montagearbeiten

Keine Verunreinigung durch Bohrspäne

Schnelle und einfache Montage der Anlage





Flotationräder für Agrotucks

Preise und Bestände finden Sie unter www.bohnenkamp.de/shop

Artikel-Nr.	Größe	Last-/ Speed-Index Reifen	Profil	Marke	Felge	Anschluss	Bolzenloch- ausführung	Einpress- tiefe	Breite in mm
59967982	445/65 R 22.5	160 J	398	Alliance	13.00 x 22.5	10/281/335	M22	+120	455
59913536	600/50 R 22.5	164 J	382	Alliance	20.00 x 22.5	10/281/335	M22	0	600
59913542	600/50 R 22.5	164 J	398	Alliance	20.00 x 22.5	10/281/335	M22	-50	620
59913540	600/50 R 22.5	164 J	398	Alliance	20.00 x 22.5	10/281/335	M22	0	620

Agrotruck-Räder mit Reifendrucksensor

Artikel-Nr.	Größe	Last-/ Speed-Index Reifen	Profil	Marke	Felge	Anschluss	Bolzenloch- ausführung	Einpress- tiefe	Breite in mm
59967981	445/65 R 22.5	160 J	398	Alliance	13.00 X 22.5	10/281/335	M22	+120	455
59913538	600/50 R 22.5	164 J	398	Alliance	20.00 x 22.5	10/281/335	M22	-50	620
59913541	600/50 R 22.5	164 J	398	Alliance	20.00 x 22.5	10/281/335	M22	0	620

Alle Räder in TL Ausführung Standardlackierung für alle Felgen ist silber









Reifendrucksensor

REIFENDRUCKSENSOR

- Montage des Sensorgurts in weniger als 30 Sekunden
- Kleinster und leichtester Reifendrucksensor mit 18 g
- Robustes Sensordesign
- Temperaturkompensierte Reifendruckwerte





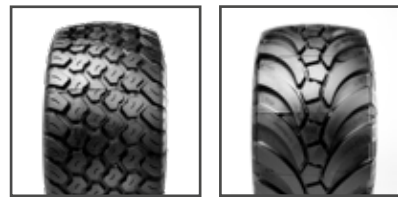

Alles auf einen Blick:

 Außen \varnothing in mm	 stat. Halbmesser in mm	 Abrollumfang in mm	 Tragfähigkeit kpl. Rad in kg	 km/h	 Luftdruck in bar
1166	532	3592	4500	100	6,00
1170	535	3587	5000	100	6,50
1172	541	3605	5000	100	6,50
1172	541	3605	5000	100	6,50



Alliance 382

Alliance 398

 Außen \varnothing in mm	 stat. Halbmesser in mm	 Abrollumfang in mm	 Tragfähigkeit kpl. Rad in kg	 km/h	 Luftdruck in bar
1166	532	3592	4500	100	6,00
1172	541	3605	5000	100	6,50
1172	541	3605	5000	100	6,50

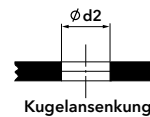

Kugelansenkung

M22

Maße für Kugelansenkung

Bezeichnung	d2	d3	R	Bolzen- gewinde
M22	26	-	-	M22x1,5

Implement-/
Flotationräder

Technische Daten:

- Reifendruck und Temperaturmessung alle 5 Sekunden
- 5 Jahre Batterielebensdauer
- Bis zu 172 PSI / 12 bar Druckbereich
- Betriebstemperatur von -40°C bis +125°C

248

MPT Reifen Diagonal

254

MPT Reifen Radial

266

Skidloaderreifen



MPT REIFEN



SERVICE-PLUS BY BOHNENKAMP

Erhalten Sie direkten Zugriff
auf unseren Online-Shop





MPT Reifen Diagonal





Preise und Bestände finden Sie unter www.bohnenkamp.de/shop

Artikel-Nr.	Größe	Last-/ Speed-Index	PR	TL/ TT	Profil	Marke	Felge ¹	Breite in mm	Außen ø in mm
19811070	400/50 - 15	109 A8/121 A8*	10 PR	TL	AS Dumper II	Starco	13.00	380	780
10000949	10.0/75 - 15.3	127 A6	10 PR	TL	AT 621 (Industrial)	BKT	9.0	267	780
15711723	10.0/75 - 15.3	111 A8/123 A8*	10 PR	TL	MP 567	BKT	9.0	258	774
15711726	10.0/75 - 15.3	118 A8/130 A8*	14 PR	TL	MP 567	BKT	9.0	258	774
15711727	10.0/75 - 15.3	123 A8/135 A8*	18 PR	TL	MP 567	BKT	9.0	258	774
19871021	255/75 - 15.3	107 A8/119 A8*	8 PR	TL	AS Dumper	Starco	9.00	256	775
15711759	11.5/80 - 15.3	119 A8/131 A8*	10 PR	TL	MP 567	BKT	9.0	292	868
15711761	11.5/80 - 15.3	126 A8/139 A8*	14 PR	TL	MP 567	BKT	9.0	292	868
15711764	11.5/80 - 15.3	130 A8/143 A8*	18 PR	TL	MP 567	BKT	9.0	292	868
19811071	295/80 - 15.3	119 A8/131 A8*	10 PR	TL	AS Dumper	Starco	9.00	286	856
19811072	380/55 - 17	125 A8/138 A8*	12 PR	TL	AS Dumper II	Starco	13.00	377	872
15231026	10.5 - 18	126 G	10 PR	TL	317	Alliance	9	270	905
15231047	10.5 - 18	130 G	12 PR	TL	317	Alliance	9	270	905
15731043	10.5 - 18	126 G	10 PR	TL	MP 567	BKT	9	270	905
15731044	10.5 - 18	130 G	12 PR	TL	MP 567	BKT	9	270	905
15731050	10.5 - 18	131 A8/130 B	10 PR	TL	MP 600	BKT	9	272	920
15772510	10.5/80 - 18	119 A8/131 A8*	10 PR	TL	AT 603	BKT	9/8	274	907
15231490	280/80 - 18	132 A8		TL	Tough Trac 325	Alliance	9	282	905
13371010	280/80 - 18	132 A8		TL	Power CL	Michelin	9/8/10	288	902
15231067	12.0 - 18	145 A6	12 PR	TL	317	Alliance	9/11	294	949
15231077	12.5 - 18	128 G	10 PR	TL	317	Alliance	11/12	325	990
15231071	12.5 - 18	131 G	12 PR	TL	317	Alliance	11/12	325	990
15231078	12.5 - 18	136 G	16 PR	TL	317	Alliance	11/12	325	990
15731073	12.5 - 18	128 G	10 PR	TL	MP 567	BKT	11/12	325	990
15731077	12.5 - 18	131 G	12 PR	TL	MP 567	BKT	11/12	325	990
15731079	12.5 - 18	136 G	16 PR	TL	MP 567	BKT	11/12	325	990
15731061	12.5 - 18	130 F	10 PR	TL	MP 570	BKT	11/12	308	990
15731065	12.5 - 18	132 B	10 PR	TL	MP 600	BKT	11/12	308	990
15731067	12.5 - 18	136 B	12 PR	TL	MP 600	BKT	11/12	308	990
19811073	315/80 - 18	136 A8/148 A8*	16 PR	TL	AS Dumper	Starco	11/9/11	314	981
15212315	12.0/75 - 18	139 A6/135 A8	12 PR	TT	317 (Spacer)	Alliance	9	299	915
15712385	12.0/75 - 18	126 A8/139 A8*	12 PR	TL	MP 567	BKT	9/11	298	915
15711878	12.5/80 - 18	129 A8/142 A8*	12 PR	TL	TR 461	BKT	9/11	305	987
15772515	12.5/80 - 18	129 A8/142 A8*	12 PR	TL	AT 621 (Industrial)	BKT	9/11.0	308	987
15772520	12.5/80 - 18	129 A8/142 A8*	12 PR	TL	AT 603	BKT	9/11	308	987
13371015	340/80 - 18	143 A8		TL	Power CL	Michelin	11/10/12	353	1006
15772531	15.5/60 - 18	141 A2	12 PR	TL	AT 621	BKT	13	394	940
15772533	15.5/70 - 18	143 A2	10 PR	TL	AT 621	BKT	13	400	1030
19811074	425/50 - 18	150 A8/134 A8*		TL	AS Dumper II	Starco	14.00	410	882

* = höhere Tragfähigkeit für Einsatz auf gezogenen Fahrzeugen, niedrigere Tragfähigkeit für Einsatz auf angetriebenen Achsen

¹ = empfohlene Felge / weitere zulässige Felgenbreiten

Alles auf einen Blick:

 statischer Halbmesser in mm	 Abrollumfang in mm	 Tragfähigkeit in kg	 km/h	 Luftdruck in bar
354	2401	1030/1450	40	3,00
		1750	30	5,25
355	2310	1090/1550	40	3,90
355	2310	1320/1900	40	5,50
355	2310	1550/2180	40	7,10
352	2235	975/1360	40	3,10
393	2578	1360/1950	40	3,40
393	2578	1700/2430	40	4,75
393	2578	1900/2725	40	6,00
388	2485	1360/1950	40	3,40
380	2581	1650/2360	40	2,80
415	2700	1700	90	3,75
415	2700	1900	90	4,50
415	2768	1700	90	3,75
415	2768	1900	90	4,50
420	2740	1950/1900	40/50	3,75
422	2727	1360/1950	40	3,70
411	2681	2000	40	4,00
413	2691	2000	40	4,00
420	2770	2900	30	4,50
450	2940	1800	90	3,00
450	2940	1950	90	3,50
450	2940	2240	90	4,50
450	2940	1800	90	3,00
450	2940	1950	90	3,50
450	2940	2240	90	4,50
450	2950	1900	80	3,00
450	2950	2000	50	3,00
450	2950	2240	50	3,50
444	2839	2240/3150	40	4,90
411	2690	2430/2180	30/40	4,00
	2723	1700/2430	40	4,00
435	2902	1850/2650	40	3,70
434	2916	2650/1850	40	5,10
448	3027	1850/2650	40	3,70
452	2988	2725	40	4,00
428	2871	2575	10	3,00
474	3111	2725	10	2,60
410	2575	2120/3350	40	3,50

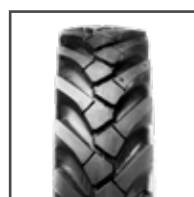

Alliance 317



Alliance 317 (Spacer)



Alliance Tough Trac 325



BKT AT 603



BKT AT 621 (Industrial)

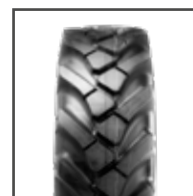

BKT MP 567



BKT MP 570



BKT MP 600



BKT TR 461

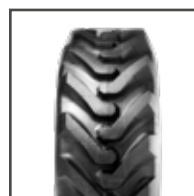

Michelin Power CL



Starco AS Dumper



Starco AS Dumper II



MPT Reifen Diagonal





Preise und Bestände finden Sie unter www.bohnenkamp.de/shop

Artikel-Nr.	Größe	Last-/ Speed-Index	PR	TL/ TT	Profil	Marke	Felge ¹	Breite in mm	Außen ø in mm
15731080	18 - 19.5	160 B	16 PR	TL	MP 567	BKT	14.00	460	1104
15731088	6.50 - 20	106 A6	10 PR	TT	MP 585	BKT	5.50/4.00/5.00	200	875
15231115	10.5 - 20	131 G	12 PR	TL	317	Alliance	9	270	955
15731092	10.5 - 20	128 G	10 PR	TL	MP 567	BKT	9	270	955
15731101	10.5 - 20	128 G	10 PR	TL	MP 585	BKT	9	273	970
13371030	280/80 - 20	133 A8		TL	Power CL	Michelin	9/8/10	287	947
15231153	12.5 - 20	129 G	10 PR	TL	317	Alliance	11	325	1040
15231161	12.5 - 20	132 G	12 PR	TL	317	Alliance	11	325	1040
15731112	12.5 - 20	129 G	10 PR	TL	MP 567	BKT	11.0/12	325	1040
15731117	12.5 - 20	132 G	12 PR	TL	MP 567	BKT	11.0/12	325	1040
15731126	12.5 - 20	132 G	12 PR	TL	MP 585	BKT	11/12	335	1050
15731121	12.5 - 20	133 F	12 PR	TL	MP 570	BKT	11/12	335	1050
15231173	14.5 - 20	136 G	12 PR	TL	317	Alliance	11/12	355	1095
15231182	14.5 - 20	139 G	14 PR	TL	317	Alliance	11/12	355	1095
15731131	14.5 - 20	136 G	12 PR	TL	MP 567	BKT	11/12	360	1116
15731134	14.5 - 20	139 G	14 PR	TL	MP 567	BKT	11/12	360	1116
15731136	14.5 - 20	148 A8/143 G	18 PR	TL	MP 567	BKT	11/12	360	1116
15731140	14.5 - 20	139 D	12 PR	TL	MP 570	BKT	11/12	360	1116
15231500	340/80 - 20	144 A8		TL	Tough Trac 325	Alliance	11/10/12	340	1045
13371035	340/80 - 20	144 A8		TL	Power CL	Michelin	11/10/12	337	1045
15772536	380/75 - 20	148 A8		TL	Con Star	BKT	12/11/13	385	1080
15772537	400/70 - 20	149 A8	16 PR	TL	Con Star	BKT	13/12/14	405	1080
15731163	400/70 - 20	152 A8	14 PR	TL	MP 600	BKT	13/12	405	1085
13371040	400/70 - 20	149 A8		TL	Power CL	Michelin	13/12/14	405	1065
15231202	16.0/70 - 20	145 G	14 PR	TL	317 (Spacer)	Alliance	13	407	1076
15231210	405/70 - 20	149 B	14 PR	TL	Traction Industrial 323	Alliance	13	407	1076
15231212	405/70 - 20	152 B	16 PR	TL	Traction Industrial 323	Alliance	13	407	1076
15731161	16.0/70 - 20	145 G	14 PR	TL	MP 567	BKT	13/12	405	1128
15731170	16.0/70 - 20	147 F	16 PR	TT	MT 612	BKT	13.00	408	1100
15712480	16.0/70 - 20	135 A8/147 A8*	10 PR	TL	AS 504	BKT	13/12/14	408	1097
19985100	16/70 - 20	147 F	14 PR	TT	Boka Agrar Trans U 27	Bohnenkamp	13	407	1076
19811075	405/70 - 20	142 A8/154 A8*	14 PR	TL	AS Dumper	Starco	14.00	407	1092
15731230	18 - 22.5	163 A8	16 PR	TL	MP 590	BKT	14.0/14.00	480	1190
19811069	500/60 - 22.5	165 A8/152 A8*		TL	MP Dumper II	Starco	16.00	514	1160
15731242	400/70 - 24	153 A8/152 B	14 PR	TL	MP 600	BKT	13/12	405	1185
15731244	400/70 - 24	158 A8/157 B	18 PR	TL	MP 600	BKT	13/12	405	1185
15772594	400/70 - 24	158 A8		TL	Con Star	BKT	13/12/14	395	1175
13371048	400/70 - 24	158 A8		TL	Power CL	Michelin	13	418	1173

* = höhere Tragfähigkeit für Einsatz auf gezogenen Fahrzeugen, niedrigere Tragfähigkeit für Einsatz auf angetriebenen Achsen

¹ = empfohlene Felge / weitere zulässige Felgenbreiten

Alles auf einen Blick:

 statischer Halbmesser in mm	 Abrollumfang in mm	 Tragfähigkeit in kg	 km/h	 Luftdruck in bar
498	3280	4500	50	6,00
410	2600	950	30	5,50
445	2880	1950	90	4,30
445	2880	1800	90	3,75
455	2890	1800	90	3,75
435	2828	2060	40	4,00
475	3090	1850	90	3,00
475	3090	2000	90	3,50
475	3090	1850	90	3,00
475	3090	2000	90	3,50
480	3130	2000	90	3,50
480	3130	2060	80	3,50
500	3260	2240	90	3,00
500	3260	2430	90	3,50
495	3315	2240	90	3,00
495	3315	2430	90	3,50
495	3315	3150/2725	40/90	4,50
505	3325	2430	65	3,00
473	3088	2800	40	4,00
474	3112	2800	40	4,00
500	3273	3150	40	4,00
501	3303	3250	40	4,00
494	3271	3550	40	4,00
480	3167	3250	40	4,00
791	3200	2900	90	3,50
496	3160	3250	50	3,50
496	3160	3550	50	4,00
490	3350	2900	90	3,50
520	3327	3075	80	4,50
487	3214	2180/3075	40	2,50
510	3150	3075	80	3,50
495	3162	2650/3750	40	3,50
530	3534	4875	40	5,50
520	3573	5150/3550	40	3,40
545	3530	3650/3550	40/50	3,50
545	3530	4250/4125	40/50	4,50
544	3556	4250	40	5,00
535	3497	4250	40	5,00

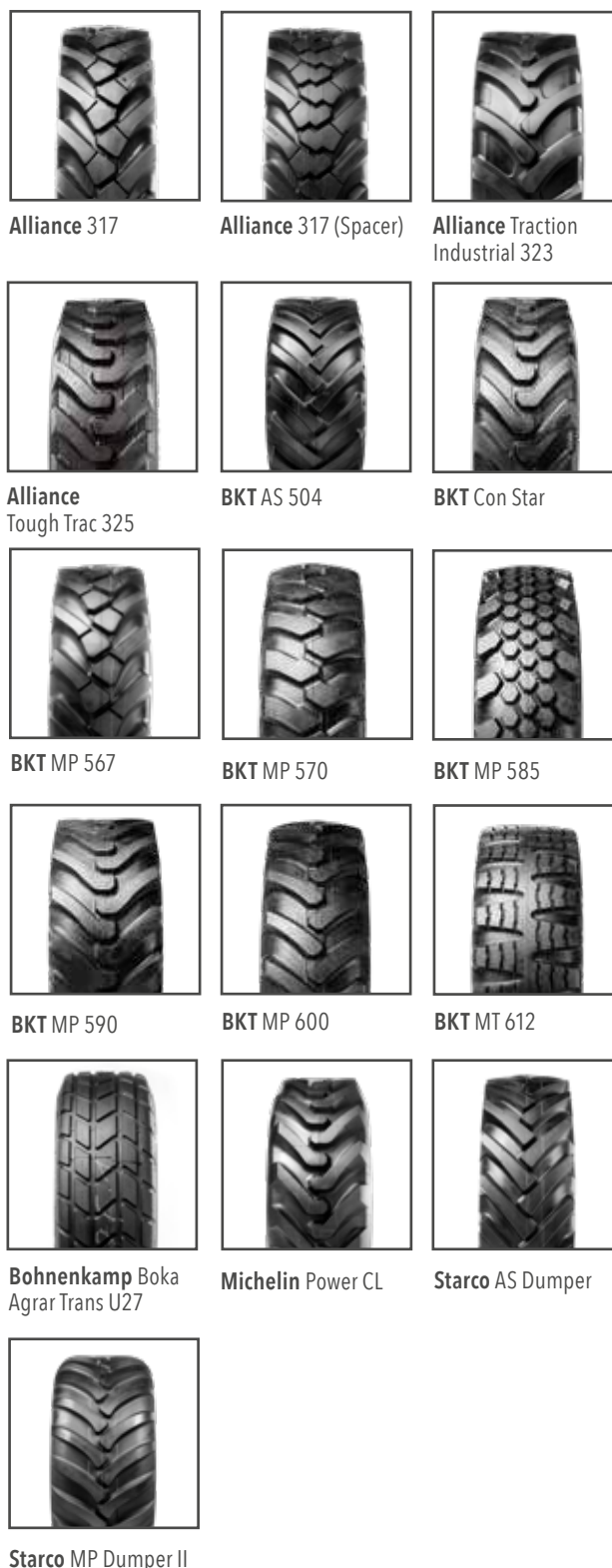

MPT Reifen



MPT Reifen Diagonal





Preise und Bestände finden Sie unter www.bohnenkamp.de/shop

Artikel-Nr.	Größe	Last-/ Speed-Index	PR	TL/ TT	Profil	Marke	Felge ¹	Breite in mm	Außen ø in mm
15272465	16/70 - 24	169 A2/152 B	14 PR	TL	326	Alliance	13.00	407	1178
15231230	405/70 - 24	152 B	14 PR	TL	Traction Industrial 323	Alliance	13	407	1178
15231505	400/80 - 24	162 A8		TL	Tough Trac 325	Alliance	13	404	1250
15772592	400/80 - 24	162 A8	20 PR	TL	Con Star	BKT	13/12/14	405	1250
13371050	400/80 - 24	162 A8		TL	Power CL	Michelin	13/14	414	1257
15231510	440/80 - 24	168 A8		TL	Tough Trac 325	Alliance	14	460	1328
15772591	440/80 - 24	168 A8	22 PR	TL	Con Star	BKT	14/13/15	455	1315
13371055	440/80 - 24	168 A8		TL	Power CL	Michelin	15/13/14	460	1328
13371049	460/70 - 24	159 A8		TL	Power CL	Michelin	15/14/16	457	1241
15772598	500/70 - 24	164 A8		TL	Con Star	BKT	16/15/18	505	1300
13371047	500/70 - 24	164 A8		TL	Power CL	Michelin	16/15	504	1315
15772599	480/80 - 26	160 A8		TL	Con Star	BKT	15/16	490	1410
13371071	480/80 - 26	167 A8		TL	Power CL	Michelin	16/15	504	1417

¹ = empfohlene Felge / weitere zulässige Felgenbreiten



Alles auf einen Blick:

 statischer Halbmesser in mm	 Abrollumfang in mm	 Tragfähigkeit in kg	 km/h	 Luftdruck in bar
577	3660	5800/3550	10/50	4,50/3,50
546	3460	3550	50	4,00
568	3725	4750	40	5,00
570	3781	4750	40	5,80
571	3743	4750	40	5,00
603	3933	5600	40	5,00
610	3986	5600	40	5,00
596	3944	5600	40	5,00
558	3687	4375	40	4,00
579	3926	5000	40	4,00
588	3903	5000	40	4,00
643	4272	4500	40	3,20
637	4210	5450	40	4,00



Alliance Traction Industrial 323



Alliance Tough Trac 325



Alliance 326



BKT Con Star



Michelin Power CL





MPT Reifen Radial





Preise und Bestände finden Sie unter www.bohnenkamp.de/shop

Artikel-Nr.	Größe	Last-/ Speed-Index	TL/ TT	Profil	Marke	Felge ¹	Breite in mm	Außen ø in mm
10927525	265/70 R 16	114 G	TL	AC 70 G MPT	Mitas	8/7/9	261	775
10927535	285/80 R 16	126 G	TL	AC 70 G MPT	Mitas	10/9	308	866
15726535	11L R 16	122 A8/122 B	TL	Agro Industrial RT 747	BKT	8/10	290	850
13326810	11L R 16	122 A8	TL	XM 27	Michelin	8/10	291	850
15735201	315/55 R 16	124 F/120 K	TL	Multimax MP 540	BKT	10.00	305	751
10935170	315/55 R 16	124 F/120 K	TL	MPT 81	Continental	10/11	302	750
15235110	265/70 R 16.5	122 A8/122 B	TL	585	Alliance	8.25	264	773
15285380	305/70 R 16.5	132 A8/132 B	TL	585	Alliance	9.75	307	831
15735200	36x12.5 R 16.5	129 N	TL	Multimax MT 518	BKT	9.75/8.25	315	902
15235122	425/55 R 17	140 A8/140 B	TL	570	Alliance	13	425	890
15235131	425/55 R 17	142 A8/142 B	TL	570	Alliance	13	425	890
15735210	425/55 R 17	134 G	TL	Multimax MP 513	BKT	13/13.00	421	900
10927500	425/55 R 17	134 G	TL	AC 70 G MPT	Mitas	13	428	884
15285251	280/80 R 18	132 A8/132 B	TL	Agro Industrial 580	Alliance	9/8/10	282	905
15735216	280/80 R 18	132 A8/132 B	TL	Multimax MP 522	BKT	9/8/10	282	907
13327310	280/80 R 18	132 A8/132 B	TL	XMCL	Michelin	9/8/10	290	908
15285253	300/75 R 18	142 A8/142 B	TL	Agro Industrial 580	Alliance	9	295	908
10927550	325/70 R 18	125 G	TL	AC 70 G MPT	Mitas	10/9/11	321	918
15284870	335/80 R 18	136 A8	TL	608	Alliance	11/10	343	992
10000803	335/80 R 18	145 A2/134 B	TL	MS910R	Maxam	11.00/11/12	334	989
10936100	335/80 R 18	132 G	TL	EM-02	Mitas	11	340	993
13315110	340/65 R 18	137 A8/149 A8*	TL	XP 27	Michelin	11/9	343	891
15285256	340/80 R 18	143 A8/143 B	TL	Agro Industrial 580	Alliance	11/10/12	350	1001
15285410	340/80 R 18	143 A8/143 B	TL	585	Alliance	11/10/12	345	1001
15735217	340/80 R 18	143 A8/143 B	TL	Multimax MP 522	BKT	11/10/12	343	1001
15735219	340/80 R 18	143 A8/143 B	TL	Multimax MP 527	BKT	11/10/12	343	1001
15735214	340/80 R 18	143 A8/143 B	TL	Multimax MP 529	BKT	11/10/12	343	1001
13327320	340/80 R 18	143 A8/143 B	TL	XMCL	Michelin	11/10/12	351	996
13375205	340/80 R 18	143 A8/143 B	TL	BibLoad Hard Surface	Michelin	11/10/12	344	990
10001120	340/80 R 18	143 A8/143 B	TL	TH 400	Trelleborg	11/10/12	351	994
14875300	340/80 R 18	143 A8/143 B	TL	ENDURION	Vredestein	11/10/12	355	1000
15735215	360/70 R 18	142 A8/142 B	TL	Multimax MP 527	BKT	11/10/12	360	969
15285030	365/70 R 18	146 A2/135 B	TL	606	Alliance	11/13	400	1000
15735226	365/70 R 18	133 G	TL	Multimax MP 513	BKT	11/12	360	969
11285058	365/70 R 18	146 A2/135 B	TL	SPT9	Dunlop	11	356	975
10000804	365/70 R 18	146 A2/135 B	TL	MS910R	Maxam	11.00/12.00/13.00	363	966
10927555	365/70 R 18	132 G	TL	AC 70 G MPT	Mitas	11/10/12	365	978
15285510	385/55 R 18	140 A8/140 B	TL	601	Alliance	11	370	890
11285055	15.5/55 R 18	138 E	TL	SP PG7	Dunlop	11	362	892
15285400	400/70 R 18	147 A8/147 B	TL	585	Alliance	13/12/13.00	404	1017

* = höhere Tragfähigkeit für Einsatz auf gezogenen Fahrzeugen, niedrigere Tragfähigkeit für Einsatz auf angetriebenen Achsen

¹ = empfohlene Felge / weitere zulässige Felgenbreiten

Alles auf einen Blick:

 statischer Halbmesser in mm	 Abrollumfang in mm	 Tragfähigkeit in kg	 km/h	 Luftdruck in bar
354	2333	1180	90	3,50
370	2540	1700	90	4,00
371	2497	1500	40/50	2,20
375	2515	1500	40	2,40
354	2325	1600/1400	80/110	6,50
348	2262	1600/1400	80/110	3,50
352	2304	1500	50	4,00
377	2466	2000	40/50	4/1,6
420	2758	1850	140	4,50
400	2656	2500	40/50	3,50
400	2663	2650	40/50	4,00
399	2695	2120	90	3,50
399	2642	2120	90	3,50
418	2776	2000	40/50	4,00
421	2748	2000	40/50	4,00
415	2708	2000	40/50	4,00
420	2697	2650	40/50	5,00
421	2765	1650	90	3,50
445	2985	2240	40	3,20
451	2996	2900/2120	10/50	3,75
448	2979	2000	90	3,50
393	2720	2300/3250	40	5,00
453	3022	2725	40/50	4,00
454	2975	2725	40/50	4,00
458	3023	2725	40/50	4,20
455	2944	2725	40/50	4,00
445	3007	2725	40/50	4,00
448	2959	2725	40/50	4,00
445	2959	2725	40/50	4,00
440	3020	2725	40/50	4,00
460	3000	2725	40/50	4,00
439	2887	2650	40/50	4,00
440	2902	3000/2180	10/50	3,75
448	2954	2060	90	3,75
438	2915	3000/2180	10/50	3,75
438	2925	3000/2180	10/50	3,75
449	2947	2000	90	3,50
395	2686	2500	40/50	3,50
409	2645	2360	70	4,75
461	3026	3075	40/50	4,00



MPT Reifen



MPT Reifen Radial

Preise und Bestände finden Sie unter www.bohnenkamp.de/shop

Artikel-Nr.	Größe	Last-/ Speed-Index	TL/ TT	Profil	Marke	Felge ¹	Breite in mm	Außen ø in mm
15285279	400/70 R 18	147 A8/147 B	TL	Agro Industrial 580	Alliance	13/12	404	1017
13327323	400/70 R 18	147 A8/147 B	TL	XMCL	Michelin	13/12	397	1012
13375207	400/70 R 18	147 A8/147 B	TL	BibLoad Hard Surface	Michelin	13/12	407	1024
10001042	400/70 R 18	147 A8/147 B	TL	TH400	Trelleborg	13/12	403	1010
14875175	400/70 R 18	147 A8/147 B	TL	ENDURION	Vredestein	13/12/14	410	1015
15284901	405/70 R 18	153 A2/141 B	TL	608	Alliance	13	408	1025
11285062	405/70 R 18	153 A2/141 B	TL	SP-T9	Dunlop	13	400	1026
10628020	405/70 R 18	141 B	TL	Duraforce Utility	Firestone	13/12/13.00	407	1025
10000809	405/70 R 18	153 A2/141 B	TL	MS910R	Maxam	13.00	407	1025
15235205	445/70 R 19.5	180 A2/173 A8	TL	624	Alliance	14	445	1105
13375011	445/70 R 19.5	180 A2/173 A8	TL	XF	Michelin	14.00	452	1110
10935030	10.5 R 20	134 J	TL	MPT 80	Continental	9/8	265	950
10001162	275/80 R 20	134 K	TL	Multimax MP 540	BKT	9	270	955
10927565	275/80 R 20	131 G	TL	AC 70 G MPT	Mitas	9	274	966
15285260	280/80 R 20	133 A8/133 B	TL	Agro Industrial 580	Alliance	9/8/10	282	956
13327330	280/80 R 20	133 A8/133 B	TL	XMCL	Michelin	9/8/10	292	958
15284907	335/80 R 20	147 A2/136 B	TL	608	Alliance	11/10/12	350	1044
15735222	335/80 R 20	149 K	TL	Multimax MP 540	BKT	11	340	1044
15735223	335/80 R 20	150 K	TL	Earthmax SR 33	BKT	11.00	335	1047
11285070	335/80 R 20	153 A2/149 K	TL	SP-T9	Dunlop	11.00	323	1035
10936150	335/80 R 20	147 K	TL	MPT-20	Mitas	11/12	340	1044
10936160	335/80 R 20	139 J	TL	MPT-21	Mitas	11/12	340	1044
10927590	335/80 R 20	134 G	TL	AC 70 G MPT	Mitas	11/10	320	1048
10935075	335/80 R 20	147 K	TL	MPT 81	Continental	11/9/10/12	320	1032
10000805	335/80 R 20	147 A2/136 B	TL	MS910R	Maxam	11.00	339	1044
10935040	12.5 R 20	132 J	TL	MPT 80	Continental	11/11	320	1030
10935060	12.5 R 20	139 J	TL	MPT 80	Continental	11/11	320	1030
10935071	12.5 R 20	147 J	TL	MPT 80	Continental	11/11	320	1030
15285271	340/80 R 20	144 A8/144 B	TL	Agro Industrial 580	Alliance	11/10/12	343	1052
10000975	340/80 R 20	144 A8/144 B	TL	585	Alliance	11/10	343	1052
15735225	340/80 R 20	144 A8/144 B	TL	Multimax MP 522	BKT	11/10/12	343	1052
15735224	340/80 R 20	144 A8/144 B	TL	Multimax MP 527	BKT	11/10/12	343	1052
13327340	340/80 R 20	144 A8/144 B	TL	XMCL	Michelin	11/10/12	353	1047
14875320	340/80 R 20	144 A8/144 B	TL	ENDURION	Vredestein	11/10/12	355	1055
15735227	14.00 R 20	164/160 J (166 G)	TL	Earthmax SR 33	BKT	10.0/9.0/10.00	390	1250
15284911	365/80 R 20	153 A2/141 B	TL	608	Alliance	11	360	1092
10000089	365/80 R 20	152 K	TL	Multimax MP 540	BKT	11	365	1086
15735265	365/80 R 20	152 K	TL	Earthmax SR 33	BKT	10.0	360	1096
11285074	365/80 R 20	168 A2/152 K	TL	SP-T9	Dunlop	11	357	1091
11285075	365/80 R 20	153 A2/141 B	TL	SP-T9	Dunlop	11/12	360	1092

¹ = empfohlene Felge / weitere zulässige Felgenbreiten

Alles auf einen Blick:

statischer Halbmesser in mm	Abrollumfang in mm	Tragfähigkeit in kg	km/h	Luftdruck in bar
461	3073	3075	40/50	4,00
451	2996	3075	40/50	4,00
512	3012	3075	40/50	4,00
450	3040	3075	40/50	4,00
465	3050	3075	40/50	4,00
450	3084	3650/2575	10/50	4,40/3,75
461	3085	3650/2575	10/50	3,75
460	3090	2575	50	3,75
437	3090	3650/2575	10/50	3,75
497	3385	8000/6500	10/40	7,50
499	3331	8000/6500	10/40	7,50
444	2865	2120	100	5,25
443	2913	2120	110	5,20
446	2890	1950	90	4,50
437	2846	2060	40/50	4,00
439	2860	2060	40/50	4,00
465	3148	3075/2240	10/50	3,75
492	3258	3250	110	6,50
464	3145	3350	110	6,50
482	3130	3650/3250	10/110	4,50
480	3132	3075	110	6,50
474	3132	2430	100	4,50
485	3168	2120	90	3,50
480	3120	3075	110	6,50
478	3147	3075/2240	10/50	3,75
480	3120	2000	100	3,50
480	3120	2430	100	4,50
480	3120	3075	100	6,50
477	3185	2800	40/50	4,00
472	3126	2800	40/50	4,00
481	3212	2800	40/50	4,00
483	3176	2800	40/50	4,00
476	3119	2800	40/50	4,00
490	3180	2800	40/50	4,00
576	3840	5000/5300	100/90	7,50
478	3326	3650/2575	10/50	3,70
495	3308	3550	110	6,25
496	3318	3550	110	6,20
502	3275	5600/3550	10/110	6,25
493	3285	3650/2575	10/50	3,75



Alliance
Agro Industrial 580

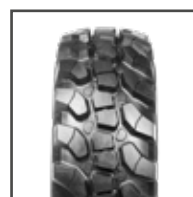

Alliance 585

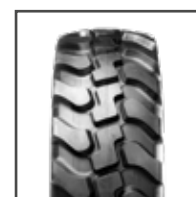

Alliance 608

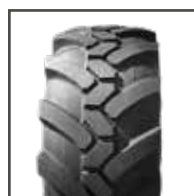

Alliance 624



BKT Earthmax SR 33

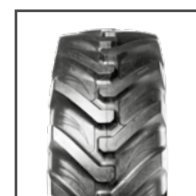

BKT Multimax MP 522



BKT Multimax MP 527



BKT Multimax MP 540



Continental MPT 80

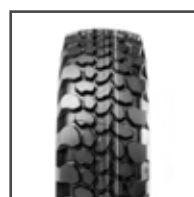

Continental MPT 81



Dunlop SP-T9

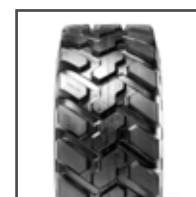

Firestone
Duraforce Utility



Maxam MS910R



Michelin BibLoad
Hard Surface



Michelin XF

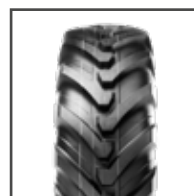

Michelin XMCL

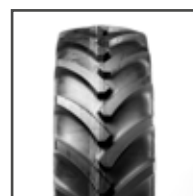

Mitas AC 70 G MPT

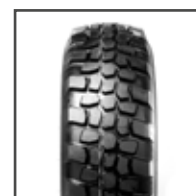

Mitas MPT-20



Mitas MPT-21



Trelleborg TH400



Vredestein ENDURION







MPT Reifen Radial

Preise und Bestände finden Sie unter www.bohnenkamp.de/shop

Artikel-Nr.	Größe	Last-/ Speed-Index	TL/ TT	Profil	Marke	Felge ¹	Breite in mm	Außen ø in mm
17436150	365/80 R 20	152 G	TL	MPT Agile	Nokian	11/12	360	1092
10966410	365/80 R 20	152 K	TL	MPT 81	Continental	11/12	378	1089
10000806	365/80 R 20	153 A2/141 B	TL	MS910R	Maxam	11.00/11/12	363	1089
10935080	14.5 R 20	132 J	TL	MPT 80	Continental	11	352	1090
10935090	14.5 R 20	143 J	TL	MPT 80	Continental	11	352	1090
10935111	14.5 R 20	152 J	TL	MPT 80	Continental	11	352	1090
10628030	365/80 R 20	153 A2/141 B	TL	Duraforce Utility	Firestone	11/12	360	1092
10936170	365/80 R 20	152 K	TL	MPT-20	Mitas	11/12	367	1092
10936180	365/80 R 20	152 J	TL	MPT-21	Mitas	11/12	360	1092
15285276	380/75 R 20	148 A8/148 B	TL	Agro Industrial 580	Alliance	12/11	380	1078
15735218	380/75 R 20	148 A8/148 B	TL	Multimax MP 522	BKT	12/11	384	1074
13327350	380/75 R 20	148 A8/148 B	TL	XMCL	Michelin	12/11	384	1070
15735228	375/70 R 20	136 G	TL	Multimax MP 513	BKT	12/10/11	377	1034
10927580	375/70 R 20	136 G	TL	AC 70 G MPT	Mitas	11/10/12	390	1034
15735221	395/85 R 20	168 J	TL	Earthmax SR 33	BKT	10.00	394	1184
15285420	400/70 R 20	149 A8/149 B	TL	585	Alliance	13/12/14	404	1067
15285281	400/70 R 20	149 A8/149 B	TL	Agro Industrial 580	Alliance	13/12/14	410	1072
15735220	400/70 R 20	149 A8/149 B	TL	Multimax MP 522	BKT	13/12/14	404	1068
15735229	400/70 R 20	149 A8/149 B	TL	Multimax MP 527	BKT	13/12/14	404	1068
10628040	400/70 R 20	149 A8	TL	Duraforce Utility	Firestone	13/12/14	404	1068
12427170	400/70 R 20	149 A8/149 B	TL	Lugker	Kleber	12/13	412	1062
13327356	400/70 R 20	149 A8/149 B	TL	XMCL	Michelin	13/12	412	1069
13375230	400/70 R 20	149 A8/149 B	TL	BibLoad Hard Surface	Michelin	13/12/14	403	1058
10001021	400/70 R 20	149 A8/149 B	TL	TH400	Trelleborg	13/12/14	395	1065
14875185	400/70 R 20	149 A8/149 B	TL	ENDURION	Vredestein	13/12/14	405	1070
15225012	405/70 R 20	136 G	TL	570	Alliance	13	421	1080
15284921	405/70 R 20	155 A2/143 B	TL	608	Alliance	13/14	407	1076
15225014	405/70 R 20	155 A2/143 B	TL	570	Alliance	13	421	1080
15735230	405/70 R 20	136 G	TL	Multimax MP 513	BKT	13/12	407	1076
15735231	405/70 R 20	136 G	TL	Multimax MP 515	BKT	13/11/12	407	1076
10000205	405/70 R 20	152 G	TL	Multimax MP 538	BKT	13	407	1076
11285091	405/70 R 20	168 A2/152 J	TL	SPT9	Dunlop	13	401	1094
10000807	405/70 R 20	155 A2/143 B	TL	MS910R	Maxam	13.00/12/13/12.00	407	1076
10927605	405/70 R 20	136 G	TL	AC 70 G MPT	Mitas	11/13	405	1065
10936200	405/70 R 20	152 J	TL	MPT-21	Mitas	13/12	407	1076
13335140	405/70 R 20	136 G	TL	XM 47	Michelin	11/10	397	1082
10468197	16.00 R 20	173/170 G	TL	WE 21	Windpower	10.00	438	1343
13327360	420/75 R 20	154 A8/154 B	TL	XMCL	Michelin	13/12/14	428	1138
15285290	425/75 R 20	154 A8/154 B	TL	Agro Industrial 580	Alliance	13/11/12/14	420	1138
15735235	425/75 R 20	148 G	TL	Multimax MP 513	BKT	13/11/12	421	1146

¹ = empfohlene Felge / weitere zulässige Felgenbreiten

Alles auf einen Blick:

 statischer Halbmesser in mm	 Abrollumfang in mm	 Tragfähigkeit in kg	 km/h	 Luftdruck in bar
505	3343	3550	90	6,25
502	3275	3550	110	6,00
498	3300	3650/2575	10/50	3,75
503	3285	2000	100	3,00
503	3285	2725	100	4,50
503	3285	3550	100	6,00
490	3285	3650/2575	10/50	3,75
495	3318	3550	110	6,25
493	3276	3550	100	6,25
487	3181	3150	40/50	4,00
483	3251	3150	40/50	4,00
481	3180	3150	40/50	4,00
472	3121	2240	90	3,50
471	3107	2240	90	4,00
538	3589	5600	100	8,50
485	3237	3250	40/50	4,00
485	3239	3250	40/50	4,00
476	3222	3250	40/50	4,00
494	3282	3250	40/50	4,00
480	3227	3250	40	4,00
480	3160	3250	40/50	4,00
481	3177	3250	40/50	4,00
525	3143	3250	40/50	4,00
475	3200	3250	40/50	4,00
490	3245	3250	40/50	4,00
495	3217	2240	90	4,00
491	3265	3875/2725	10/50	3,70/3,72
495	3291	3875/2725	10/50	3,75
493	3253	2240	90	3,50
493	3286	2240	90	3,50
484	3289	3550	90	6,00
495	3230	5600/3550	10/100	6,00
493	3260	3875/2725	10/50	3,75
485	3225	2240	90	3,50
492	3228	3550	100	6,00
490	3232	2240	90	4,10
591	4050	6500	90	7,60
509	3378	3750	40/50	4,00
511	3449	3750	40/50	4,00
521	3479	3150	90	4,00



MPT Reifen







MPT Reifen Radial

Preise und Bestände finden Sie unter www.bohnenkamp.de/shop

Artikel-Nr.	Größe	Last-/ Speed-Index	TL/ TT	Profil	Marke	Felge ¹	Breite in mm	Außen ø in mm
15735234	425/75 R 20	148 G	TL	Multimax MP 515	BKT	13/11/12	421	1146
10927615	425/75 R 20	148 G	TL	AC 70 G MPT	Mitas	13/11	441	1148
13335160	425/75 R 20	148 G	TL	XM 47	Michelin	13/11	440	1152
15284925	455/70 R 20	162 A2/150 B	TL	608	Alliance	14	445	1146
10001016	24 R 20.5	176 F	TL	392	Alliance	18.00	600	1372
15717300	24 R 20.5	176 F	TL	Ridemax FL 699	BKT	18.00	590	1370
13366470	24 R 20.5	176 F	TL	XS	Michelin	18	602	1374
15216272	445/65 R 22.5	160 J	TL	398	Alliance	14.00/13.00	455	1166
10927620	445/65 R 22.5	160 G	TL	AC 70 +	Mitas	14/13	450	1172
10436000	445/65 R 22.5	169 F	TL	WGP 23	Windpower	14.00/13.00	438	1178
10436010	445/65 R 22.5	169 F	TL	WE 77	Windpower	14.00/13.00	443	1149
15235210	445/70 R 22.5	182 A2/175 A8	TL	624	Alliance	14	454	1195
13375022	445/70 R 22.5	182 A2/175 A8	TL	XF	Michelin	14.00	452	1192
15216303	600/50 R 22.5	164 J	TL	398	Alliance	20.00	620	1172
15735236	400/70 R 24	152 A8/152 B	TL	Multimax MP 522	BKT	13/12/14	404	1170
15735243	400/70 R 24	152 A8/152 B	TL	Multimax MP 527	BKT	13/12/14	404	1170
13327370	400/70 R 24	152 A8/152 B	TL	XMCL	Michelin	13/12/14	401	1170
10627376	400/70 R 24	158 A8	TL	R8000 Utility	Firestone	13/12/14	405	1180
10001020	400/70 R 24	158 A8/158 B	TL	TH400	Trelleborg	13/12/14	400	1165
14875195	400/70 R 24	152 A8/152 B	TL	ENDURION	Vredestein	13/12/14	405	1170
10000976	400/80 R 24	162 A8/162 B	TL	585	Alliance	13/12/14	404	1250
15735237	400/80 R 24	162 A8/162 B	TL	Multimax MP 522	BKT	13/12/14	404	1250
15735241	400/80 R 24	162 A8/162 B	TL	Multimax MP 527	BKT	13/12/14	404	1250
14875340	400/80 R 24	162 A8/162 B	TL	ENDURION	Vredestein	13	410	1245
15285305	405/70 R 24	152 A8/152 B	TL	Agro Industrial 580	Alliance	13	404	1170
15285200	405/70 R 24	158 A2	TL	606	Alliance	13	425	1180
11285100	405/70 R 24	168 A2/152 J	TL	SPT9	Dunlop	13.00	401	1094
10000808	405/70 R 24	158 A2/146 B	TL	MS910R	Maxam	13.00	407	1178
10927675	405/70 R 24	149 G	TL	AC 70 G MPT	Mitas	13	419	1166
10936350	405/70 R 24	152 J	TL	MPT-21	Mitas	13	407	1178
15285330	440/80 R 24	161 A8/161 B	TL	Agro Industrial 580	Alliance	14/15	449	1309
15285435	440/80 R 24	161 A8/161 B	TL	585	Alliance	14/15	441	1314
13327376	440/80 R 24	161 A8/161 B	TL	XMCL	Michelin	14/15	441	1314
15735242	440/80 R 24	161 A8/161 B	TL	Multimax MP 522	BKT	14/13/15	441	1314
15735238	440/80 R 24	161 A8/161 B	TL	Multimax MP 527	BKT	14/13/15	441	1314
10001119	440/80 R 24	161 A8/161 B	TL	TH 400	Trelleborg	14/15	457	1312
15235220	445/70 R 24	151 G	TL	570	Alliance	15/14	445	1234
15216322	445/70 R 24	151 J	TL	398	Alliance	14/15	455	1242
11285110	445/70 R 24	174 A2/154 G	TL	SPT9	Dunlop	14/15	442	1247

¹ = empfohlene Felge / weitere zulässige Felgenbreiten

Alles auf einen Blick:

 statischer Halbmesser in mm	 Abrollumfang in mm	 Tragfähigkeit in kg	 km/h	 Luftdruck in bar
522	3491	3150	90	4,00
521	3440	3150	90	4,00
513	3431	3150	90	4,10
518	3465	4750/3350	10/50	3,75
620	4210	7100	80	6,00
613	4165	7100	80	6,00
584	4148	7100	80	6,00
532	3592	4500	100	6,00
536	3525	4500	90	6,00
518	3478	5800	80	7,90
525	3504	5800	80	8,20
539	3646	8500/6900	10/40	7,50
539	3582	8500/6900	10/40	7,50
541	3605	5000	100	6,50
533	3527	3550	40/50	4,00
542	3597	3550	40/50	4,00
531	3485	3550	40/50	4,00
531	3566	4250	40	5,00
520	3520	4250	40/50	4,00
540	3510	3550	40/50	4,00
567	3752	4750	40/50	5,00
553	3778	4750	40/50	5,00
578	3834	4750	40/50	5,00
570	3720	4750	40/50	5,00
538	3521	3550	40/50	4,00
538	3548	4250	10	3,75
538	3545	5600/3550	10/100	5,00
508	3551	4250/3000	10/50	4,00
541	3530	3250	90	4,50
538	3534	3550	100	5,00
591	3865	4625	40/50	4,00
592	3936	4625	40/50	4,00
592	3907	4625	40/50	4,00
586	3958	4625	40/50	4,00
601	3985	4625	40/50	4,00
585	3975	4625	40/50	4,00
564	3670	3450	90	4,00
573	3785	3450	100	4,50
576	3745	6700/3750	10/90	3,75



Alliance 392



Alliance 398

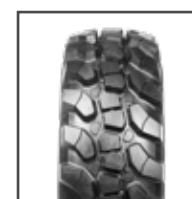

Alliance 585

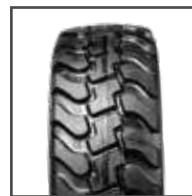

Alliance 606

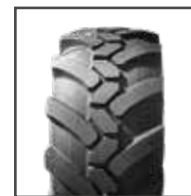

Alliance 624

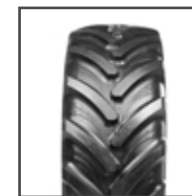

BKT Multimax MP 515



BKT Multimax MP 522



BKT Multimax MP 527

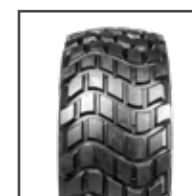

BKT Ridemax FL 699



Dunlop SP-T9



Firestone R8000 Utility

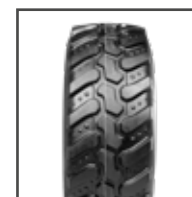

Maxam MS910R

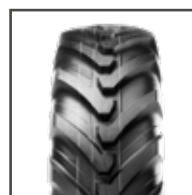

Michelin XMCL



Michelin XS

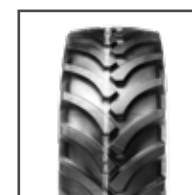

Mitas AC 70 +

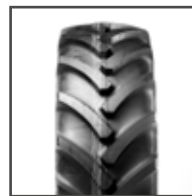

Mitas AC 70 G MPT

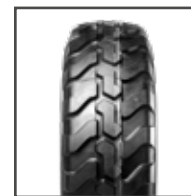

Mitas MPT-21



Trelleborg TH400

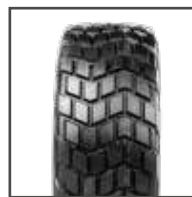

Windpower WE 77



Windpower WGP 23



Vredestein ENDURION



MPT Reifen Radial





Preise und Bestände finden Sie unter www.bohnenkamp.de/shop

Artikel-Nr.	Größe	Last-/ Speed-Index	TL/ TT	Profil	Marke	Felge ¹	Breite in mm	Außen ø in mm
10927705	445/70 R 24	151 G	TL	AC 70 G MPT	Mitas	13/12/14	425	1248
13335201	445/70 R 24	151 G	TL	XM 47	Michelin	15/14	460	1242
15285210	455/70 R 24	165 A2/154 B	TL	606	Alliance	14/13/15	473	1247
15285312	460/70 R 24	159 A8/159 B	TL	Agro Industrial 580	Alliance	15/14	462	1250
15235226	460/70 R 24	159 A8/159 B	TL	585	Alliance	15/14/16	471	1242
15226012	460/70 R 24	159 A8/159 B	TL	570	Alliance	15/14	445	1245
15735240	460/70 R 24	159 A8/159 B	TL	Multimax MP 522	BKT	15/14/16	465	1250
15735239	460/70 R 24	159 A8/159 B	TL	Multimax MP 527	BKT	15/14/16	465	1254
10628200	460/70 R 24	159 A8	TL	Duraforce Utility	Firestone	15/14	458	1245
10627381	460/70 R 24	159 A8/159 B	TL	R8000 Utility	Firestone	15/14	486	1274
12427190	460/70 R 24	159 A8/159 B	TL	Lugker	Kleber	15/14/16	469	1240
13327380	460/70 R 24	159 A8/159 B	TL	XMCL	Michelin	15/14/16	467	1248
13375240	460/70 R 24	159 A8/159 B	TL	BibLoad Hard Surface	Michelin	15/14/16	467	1241
10001019	460/70 R 24	159 A8/159 B	TL	TH400	Trelleborg	15/14/16	465	1250
14875050	460/70 R 24	159 A8/159 B	TL	TRAXION VERSA	Vredestein	15/14/16	480	1255
14875200	460/70 R 24	159 A8/159 B	TL	ENDURION	Vredestein	15/14/16	480	1265
10000828	460/70 R 24	159 A8/159 B	TL	MS910R	Maxam	15/14/16	460	1249
15235235	495/70 R 24	155 G	TL	570	Alliance	16	499	1304
15216332	495/70 R 24	155 J	TL	398	Alliance	16/15/14	512	1310
15735245	495/70 R 24	155 G	TL	Multimax MP 513	BKT	16/15	499	1304
13335211	495/70 R 24	155 G	TL	XM 47	Michelin	16	506	1313
15235237	500/70 R 24	155 A8/164 A8*	TL	570	Alliance	16/15	495	1312
15226020	19.5LR24	156 A8/153 B	TL	570	Alliance	16/15	495	1320
15285321	500/70 R 24	164 A8/164 B	TL	Agro Industrial 580	Alliance	16/15	505	1308
15235238	500/70 R 24	164 A8/164 B	TL	585	Alliance	16/15	497	1310
15735250	500/70 R 24	164 A8/164 B	TL	Multimax MP 522	BKT	16/15/18	503	1310
15735252	500/70 R 24	164 A8/164 B	TL	Multimax MP 527	BKT	16/15/18	503	1310
10628150	500/70 R 24	164 A8/164 B	TL	Duraforce Utility	Firestone	16/15	520	1329
12427195	500/70 R 24	164 A8/164 B	TL	Lugker	Kleber	16/15	511	1298
11384120	500/70 R 24	164 A/164 B	TL	LR400	Linglong	16/15	503	1310
13375247	500/70 R 24	164 A8/164 B	TL	BibLoad Hard Surface	Michelin	16/15	511	1296
13327390	500/70 R 24	164 A8/164 B	TL	XMCL	Michelin	16/15	511	1302
10001121	500/70 R 24	164 A8/164 B	TL	TH 400	Trelleborg	16/15	495	1302
14875060	500/70 R 24	164 A8/164 B	TL	TRAXION VERSA	Vredestein	16/15/18	515	1320
14875210	500/70 R 24	164 A8/164 B	TL	ENDURION	Vredestein	16/15/18	520	1315
15235241	500/85 R 24	158 A8/171 A8*	TL	570	Alliance	16/15	528	1458
10000977	540/70 R 24	168 A8/168 B	TL	585	Alliance	18/16	540	1366
15735255	540/70 R 24	168 A8/168 B	TL	Multimax MP 522	BKT	16/18	530	1366
13375248	540/70 R 24	168 A8/168 B	TL	BibLoad Hard Surface	Michelin	18/16	562	1350
13327395	540/70 R 24	168 A8/168 B	TL	XMCL	Michelin	18/16	562	1356

* = höhere Tragfähigkeit für Einsatz auf gezogenen Fahrzeugen, niedrigere Tragfähigkeit für Einsatz auf angetriebenen Achsen

¹ = empfohlene Felge / weitere zulässige Felgenbreiten

Alles auf einen Blick:

 statischer Halbmesser in mm	 Abrollumfang in mm	 Tragfähigkeit in kg	 km/h	 Luftdruck in bar
561	3708	3450	90	3,50
564	3705	3450	90	4,10
537	3580	5150/3750	10/50	3,75
567	3701	4375	40/50	4,00
560	3704	4375	40/50	4,00
564	3682	4375	40/50	4,00
568	3766	4375	40/50	4,00
574	3801	4375	40/50	4,00
560	3762	4375	40	4,00
573	3850	4375	40/50	4,00
560	3704	4375	40/50	4,00
562	3709	4375	40/50	4,00
558	3688	4375	40/50	4,00
555	3790	4375	40/50	4,00
570	3800	4375	40/50	4,00
570	3820	4375	40/50	4,00
590	3785	4375	40/50	4,00
588	3845	3875	90	4,00
603	3849	3875	100	4,50
588	3974	3875	90	3,50
587	3916	3875	90	4,10
569	3905	3875/5000	40	3,40
600	3912	4000	40	3,00
600	3900	5000	40/50	4,00
591	3920	5000	40/50	4,00
595	3940	5000	40/50	4,00
597	4019	5000	40/50	4,00
598	4012	5000	40/50	4,00
582	3830	5000	40/50	4,00
592	3873	5000	40/50	4,00
581	3866	5000	40/50	4,00
583	3866	5000	40/50	4,00
580	3940	5000	40/50	4,00
595	4020	5000	40/50	4,00
595	4000	5000	40/50	4,00
625	4365	4250/6150	40	2,80
598	4080	5600/5800	40/50	4,00
611	4133	5600	40/50	4,00
605	4026	5600	40/50	4,00
608	4026	5600	40/50	4,00

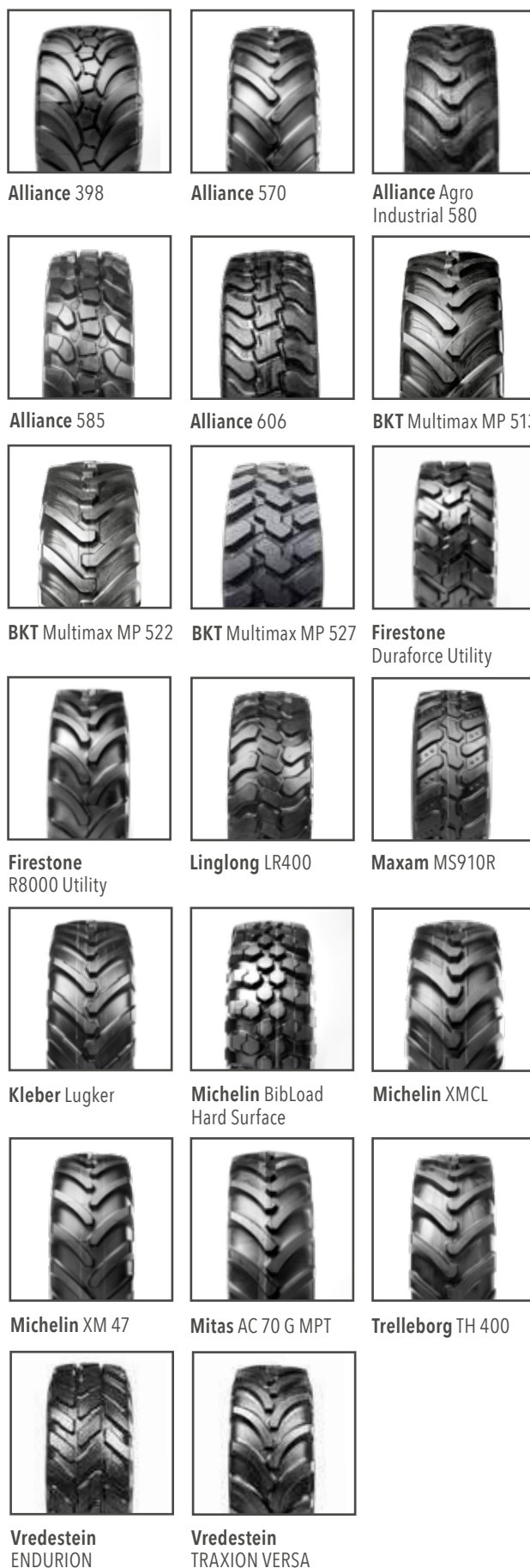

MPT Reifen



MPT Reifen Radial





Preise und Bestände finden Sie unter www.bohnenkamp.de/shop

Artikel-Nr.	Größe	Last-/ Speed-Index	TL/ TT	Profil	Marke	Felge ¹	Breite in mm	Außen ø in mm
15285335	480/80 R 26	160 A8/160 B	TL	Agro Industrial 580	Alliance	15/16	489	1423
10000978	480/80 R 26	167 A8/167 B	TL	585	Alliance	15/16	484	1428
15735340	480/80 R 26	160 A8/160 B	TL	Multimax MP 522	BKT	15/16	479	1428
15735344	480/80 R 26	160 A8/160 B	TL	Multimax MP 527	BKT	15/16	479	1428
13327422	480/80 R 26	167 A8/167 B	TL	XMCL	Michelin	15/16	495	1422
13375270	480/80 R 26	167 A8/167 B	TL	BibLoad Hard Surface	Michelin	15/16	487	1416
10001122	480/80 R 26	160 A8/160 B	TL	TH 400	Trelleborg	15/16	495	1425
14875350	480/80 R 26	160 A8/160 B	TL	ENDURION	Vredestein	15/16	495	1440
10000863	800/45 R 26.5	174 D	TL	MS961R FLOXTRA	Maxam	28.00	828	1393
15285340	440/80 R 28	156 A8/156 B	TL	Agro Industrial 580	Alliance	14/15	460	1410
10000979	440/80 R 28	163 A8/163 B	TL	585	Alliance	14/13/15	441	1415
15735360	440/80 R 28	156 A8/156 B	TL	Multimax MP 522	BKT	14/13/15	441	1415
15735358	440/80 R 28	156 A8/156 B	TL	Multimax MP 527	BKT	14/13/15	441	1415
10628220	440/80 R 28	156 A8	TL	Duraforce Utility	Firestone	14/15	441	1420
14875360	440/80 R 28	156 A8/156 B	TL	ENDURION	Vredestein	14/13/15	455	1420
10627400	440/80 R 28	156 A8	TL	R8000 Utility	Firestone	14/15	460	1420
13327460	440/80 R 28	156 A8/156 B	TL	XMCL	Michelin	14/15	459	1410
10001018	440/80 R 28	156 A8/156 B	TL	TH400	Trelleborg	14/15	457	1418
15285350	500/70 R 28	164 A8/164 B	TL	Agro Industrial 580	Alliance	16/15	503	1411
10927910	495/70 R 30	147 G	TL	AC 70 G MPT	Mitas	15/14/16	486	1462
15235255	500/85 R 30	170 A8/176 A8*	TL	570	Alliance	16/15	505	1602
17427312	580/65 B 30	161 B	TL	TRI Backhoe	Nokian	16/18/20	580	1516
15235260	620/70 R 30	166 A8/178 A8*	TL	570	Alliance	20/18	608	1622
17427314	580/65 B 34	164 B	TL	TRI Backhoe	Nokian	16/18/20	580	1618

* = höhere Tragfähigkeit für Einsatz auf gezogenen Fahrzeugen, niedrigere Tragfähigkeit für Einsatz auf angetriebenen Achsen

¹ = **empfohlene Felge** / weitere zulässige Felgenbreiten

Alles auf einen Blick:

 statischer Halbmesser in mm	 Abrollumfang in mm	 Tragfähigkeit in kg	 km/h	 Luftdruck in bar
642	4268	4500	40/50	3,20
641	4258	5450	40/50	4,00
638	4287	4500	40/50	3,20
642	4259	4500	40/50	3,20
635	4218	5450	40/50	4,00
644	4220	5450	40/50	4,00
630	4315	4500	40/50	3,20
645	4320	4500	40/50	3,20
627	4220	6700	65	4,00
642	4183	4000	40/50	3,20
633	4276	4875	40/50	4,00
643	4278	4000	40/50	3,20
648	4270	4000	40/50	3,20
637	4291	4000	40	3,20
640	4290	4000	40/50	3,20
639	4291	4000	40	3,20
641	4200	4000	40/50	3,20
633	4295	4000	40/50	3,20
643	4187	5000	40/50	4,00
666	4325	3075	90	2,50
698	4802	6000/7100	40	2,80
698	4530	4625	50	3,20
727	4835	5300/7500	40	2,50
752	4832	5000	50	3,20

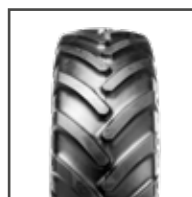

Alliance 570

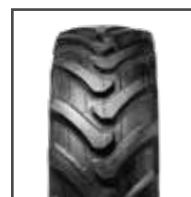

Alliance Agro Industrial 580



Alliance 585



BKT Multimax MP 522



BKT Multimax MP 527

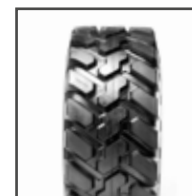

Firestone Duraforce Utility



Firestone R8000 Utility



Maxam MS961R FLOXTRA



Michelin BibLoad Hard Surface

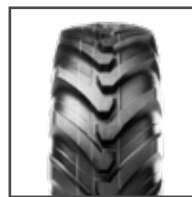

Michelin XMCL

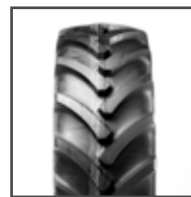

Mitas AC 70 G MPT



Nokian TRI Backhoe



Trelleborg TH 400



Vredestein ENDURION







Skidloaderreifen

Preise und Bestände finden Sie unter www.bohnenkamp.de/shop

Artikel-Nr.	Größe	Last-/ Speed-Index	PR	TL/ TT	Profil	Marke	Felge ¹	Breite in mm	Außen ø in mm
15772000	18x8.50 - 8	97 A2	8 PR	TL	Skid Power HD	BKT	7.00	210	460
15772022	18x8.5 - 10	82 A8	8 PR	TL	Skid Power HD	BKT	7.00/6.00	205	465
15772041	23x8.5 - 12	87 A8	6 PR	TL	Skid Power HD	BKT	7.00	215	585
19271084	23x8.50 - 12	101 A2	6 PR	TL	K395 Power Grip	Kenda	7.00	216	572
19271086	23x8.50 - 12	106 A2	8 PR	TL	K395 Power Grip	Kenda	7.00	217	564
15772050	26x12 - 12	119 A2	8 PR	TL	Skid Power HD	BKT	10.50/8.50/8.5/9.5/10.5	305	660
19271088	26x12.00 - 12	125 A2	10 PR	TL	K395 Power Grip	Kenda	10.5/9.5/10.0	304	670
19271085	23x8.50 - 12	107 A2	12 PR	TL	K395 Power Grip	Kenda	7.00	212	575
15772046	23x8.50 - 12	98 A8	12 PR	TL	Skid Power HD	BKT	7.00	215	585
15772054	26x12 - 12	114 A8	12 PR	TL	Skid Power HD	BKT	10.50/8.50/8.5/9.5	305	660
15772058	27x10 - 12	152 A2	14 PR	TT	Skid Power HD	BKT	8.00	255	700
15772065	25x8.5 - 14	102 A2	6 PR	TL	Skid Power	BKT	7	213	652
15772096	7.00 - 15	106 A8	6 PR	TL	Skid Power (Chevron)	BKT	5.50/6	203	762
19271098	27x8.50 - 15	96 A2	6 PR	TL	K395 Power Grip	Kenda	7.0/8.0	227	674
15772061	27x8.5 - 15	102 A8	8 PR	TL	Skid Power HD	BKT	7	218	676
19271099	27x8.50 - 15	113 A2	8 PR	TL	K395 Power Grip	Kenda	7.0/8.0	222	660
15772091	27x10.5 - 15	105 A8	8 PR	TL	Skid Power HD	BKT	8	256	684
15772094	31x15.5 - 15	125 A8	10 PR	TL	Skid Power HD	BKT	13	400	790
15772101	10 - 16.5	116 A8	8 PR	TL	Skid Power	BKT	8.25	254	775
15272113	10 - 16.5	129 A2	8 PR	TL	SK 903	Alliance	8.25	260	773
15272114	10 - 16.5	134 A2	10 PR	TL	SK 903	Alliance	8.25	260	773
15772110	10 - 16.5	134 A2	10 PR	TL	Skid Power HD	BKT	8.25	267	780
15772116	10 - 16.5	120 A8	10 PR	TL	Sure Trax HD	BKT	8.25	268	785
15772121	10 - 16.5	120 A8	10 PR	TL	Skid Power SK	BKT	8.25	270	775
19271111	10 - 16.5	135 A2	10 PR	TL	K395 Power Grip	Kenda	8.25	271	785
15772135	260/70 R 16.5	129 A8/129 B		TL	Skidmax SR-Skidder	BKT	8.25/7.50/9.00	263	776
15772139	12 - 16.5	125 A8	10 PR	TL	Skid Power	BKT	9.75	305	821
15272125	12 - 16.5	140 A2	10 PR	TL	SK 903	Alliance	9.75	307	831
19271113	12 - 16.5	141 A2	10 PR	TL	K395 Power Grip	Kenda	9.75	318	855
15772144	12 - 16.5	125 A8	10 PR	TL	Skid Power HD	BKT	9.75	324	850
15772151	12 - 16.5		10 PR	TL	Snow-Ride	BKT	9.75	305	835
15285380	305/70 R 16.5	132 A8/132 B		TL	585	Alliance	9.75	307	831
15772153	31.5x13 - 16.5	124 A8	10 PR	TL	Skid Power HD	BKT	9.75	330	795
15272115	12 - 16.5		12 PR	TL	SK 903	Alliance	9.75	307	831
15772141	12 - 16.5	130 A8	12 PR	TL	Skid Power SK	BKT	9.75	312	825
15772152	12 - 16.5	130 A8	12 PR	TL	Sure Trax HD	BKT	9.75	325	855
19800555	12 - 16.5	145 A2	12 PR	TL	SG-810	Deli	9.75	313	836
19271114	12 - 16.5	145 A2	12 PR	TL	K395 Power Grip	Kenda	9.75	316	860
15772155	33x15.5 - 16.5	148 A2	12 PR	TL	Skid Power HD	BKT	13.00/12.00	394	838
15772161	14 - 17.5	141 A8	14 PR	TL	Skid Power	BKT	10.50	355	940
15772163	14 - 17.5	141 A8	14 PR	TL	Skid Power HD	BKT	10.50	350	930
15772169	15 - 19.5	146 A8	14 PR	TL	Skid Power HD	BKT	11.75/12.25	400	1019

Alles auf einen Blick:

 statischer Halbmesser in mm	 Abrollumfang in mm	 Tragfähigkeit in kg	 km/h	 Luftdruck in bar
207	1357	730	10	3,00
213	1372	475	40	3,00
271	1764	545	40	3,40
266	1736	825	10	3,10
267	1725	950	10	4,10
297	1947	1360	10	3,40
312	2033	1650	10	4,50
270	1735	975	10	6,90
271	1764	750	40	6,20
297	1947	1180	40	5,40
328	2133	3650	10	6,90
305	1912	850	10	3,40
347	2295	950	40	4,10
322	2073	710	10	3,10
324	2004	850	40	4,20
311	2023	1150	10	4,10
316	2020	925	40	4,20
360	2330	1650	40	4,20
355	2286	1250	40	4,10
356	2351	1850	10	4,10
356	2351	2120	10	5,20
362	2350	2120	10	5,20
359	2316	1400	40	5,20
355	2286	1400	40	5,20
354	2342	2180	10	4,80
	2367	1850	40/50	5,00
373	2422	1650	40	4,50
380	2510	2500	10	4,50
398	2595	2575	10	4,50
385	2508	1650	40	4,50
	2505	2540	10	4,50
377	2466	2000	40/50	4,0/1,6
363	2345	1600	40	4,80
380	2510	2800	10	5,50
375	2434	1900	40	5,50
387	2522	1900	40	5,50
373	2491	2900	10	5,20
401	2610	2900	10	5,50
387	2563	3150	10	4,80
424	2773	2575	40	5,50
420	2744	2575	40	5,50
463	3090	3000	40	4,85



Alliance SK 903

Alliance 585

BKT Skid Power



BKT Skid Power HD

BKT Skid Power SK

BKT Skid Power (Chevron)



BKT Skidmax SR-Skidder

BKT Snow-Ride

BKT Sure Trax HD

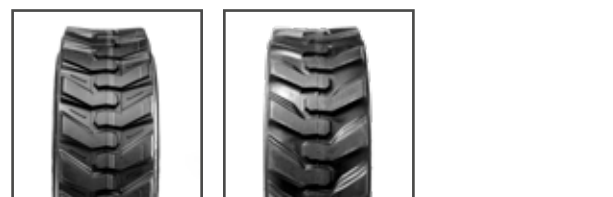

Deli SG-810

Kenda K395 Power Grip

¹ = empfohlene Felge / weitere zulässige Felgenbreiten

270

EM Baggerreifen

272

EM Reifen Diagonal

274

EM Reifen Radial



EM- UND BAGGERREIFEN



SERVICE-PLUS BY BOHNENKAMP

Erhalten Sie direkten Zugriff
auf unseren Online-Shop





EM Baggerreifen







Preise und Bestände finden Sie unter www.bohnenkamp.de/shop

Artikel-Nr.	Größe	Last-/ Speed-Index	PR	TL/ TT	Profil	Marke	Felge ¹	Breite in mm
19981682	7.50 - 20	126 B	14 PR	TT/Set	SKL800	Boka Terra	6.0 /6.5	215
15772202	8.25 - 20	133 B	14 PR	TT/Set	EM 936	BKT	6.5 /6/7	235
19981683	8.25 - 20	133 B	14 PR	TT/Set	SKL800	Boka Terra	6.5 /7.0	245
15772212	9.00 - 20	140 B	14 PR	TT/Set	EM 936	BKT	7.0 /6.5/7.5	256
19981685	9.00 - 20	140 B	14 PR	TT/Set	SKL800	Boka Terra	7.0 /7.50	260
15772222	10.00 - 20	146 B	16 PR	TT/Set	EM 936	BKT	7.5 /7.0/8.0	275
15772223	10.00 - 20	146 B	16 PR	TT/Set	EM 936 Super	BKT	7.5 /7.0/8.0	277
19981687	10.00 - 20	148 B	16 PR	TT/Set	SKL800	Boka Terra	7.5 /8.0	280
19981688	10.00 - 20	146 B	16 PR	TT/Set	SKL800	Boka Terra	7.5 /7.0/8.0	280
15772232	11.00 - 20	149 B	16 PR	TT/Set	EM 936	BKT	8 /7.5/8.5	295
19981689	11.00 - 20	148 B	16 PR	TT/Set	SKL800	Boka Terra	8.0 /7.50/8.00	293
10000337	290/90 - 20	168 A2/152 B	18 PR	TT/Set	EM 933 SUPER	BKT	8.0	295
19912089	315/70 R 22.5	152/148 A7		TL	Boka Terra	Runderneuert	8.25	302
19912122	315/70 R 22.5	152/148 A7		TL	Boka Terra II	Runderneuert	8.25	309
19968077	315/80 R 22.5	152/148 A7		TL	Boka Terra	Runderneuert	8.25	302
15283112	315/80 R 22.5	158 A8		TL	Dual Master 506	Alliance	9	330
15283117	315/80 R 22.5	158 A8		TL	Dual Master 528	Alliance	9/9.00	326

¹ = **empfohlene Felge** / weitere zulässige Felgenbreiten



Alles auf einen Blick:

 Außen ø in mm	 statischer Halbmesser in mm	 Abroll- umfang in mm	 Tragfähigkeit	 km/h	 Luftdruck in bar
963			1700	50	7,40
980	467	2970	2060	50	6,75
992			2060	50	6,75
1012	481	3070	2500	50	7,00
1030			2500	50	7,00
1050	498	3180	3000	50	7,50
1080	500	3336	3000	50	7,50
1062	498	3180	3150	50	7,50
1062			3000	50	8,10
1090	508	3302	3250	50	7,20
1095			3150	50	7,25
1055			5600/3550	10/50	9,00
1043		3275	3550	35	8,00
1043		3275	3550	35	8,00
1100		3445	3550	35	9,00
1100	509	3366	4250	40	9,00
1100	508	3343	4250	40	9,00

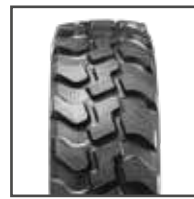

Alliance Dual
Master 506



Alliance Dual
Master 528



BKT EM 936



BKT EM 936 Super



Runderneuert
Boka Terra



Runderneuert
Boka Terra II



Boka Terra
SKL800







EM Reifen Diagonal

Preise und Bestände finden Sie unter www.bohnenkamp.de/shop

Artikel-Nr.	Größe	Last-/ Speed-Index	PR	TL/ TT	Profil	Marke	Felge ¹	Breite in mm
15272280	16.0/70 - 20	166 A2/149 B	14 PR	TL	326	Alliance	13	407
15772242	16.0/70 - 20	166 A2/149 B	14 PR	TL	EM 936	BKT	13	405
15772540	13.00 - 24	143 A8	12 PR	TL	Trac Grader +	BKT	8.00/9.00/1.5/10.00/VA	340
15772552	14.00 - 24	153 A8	16 PR	TL	Trac Grader +	BKT	8.00/9.00/1.5/10.00/VA	364
15772250	16.0/70 - 24	169 A2/152 B	14 PR	TL	EM 936	BKT	13	410
15772260	20 - 24	173 A2/158 B	12 PR	TL	EM 936	BKT	16.00	535
15272530	15.5 - 25	149 B	12 PR	TL	308	Alliance	12	394
15772645	15.5 - 25	162 A2/142 A8	12 PR	TL	GR 288	BKT	12.00/1.3	385
15772648	15.5 - 25		12 PR	TL	XL Grip	BKT	12.00/1.3	402
15772633	16.00 - 25		32 PR	TL	XL Grip	BKT	11.25/2.0/13.00/2.0	465
15272547	17.5 - 25		16 PR	TL	307	Alliance	14	440
15272540	17.5 - 25	153 B	12 PR	TL	308	Alliance	14	444
15272542	17.5 - 25	158 B	16 PR	TL	308	Alliance	14	444
15772654	17.5 - 25	150 A8/177 A2	16 PR	TL	GR 288	BKT	14.00/1.5/14.00/1.3	445
15772656	17.5 - 25		16 PR	TL	Loader Plus	BKT	14.00/1.5	440
15772650	17.5 - 25		16 PR	TL	XL Grip	BKT	14.00/1.5	435
15772652	17.5 - 25	188 A2/171 B	24 PR	TL	XL Grip	BKT	14.00/1.5	435
15272567	20.5 - 25		16 PR	TL	307	Alliance	17.00/2.5	518
15272560	20.5 - 25	167 B	16 PR	TL	308	Alliance	17	520
15772662	20.5 - 25	156 A8/181 A2	16 PR	TL	GR 288	BKT	17.00/2.0/17.00/1.7	520
15772665	20.5 - 25	160 A8	20 PR	TL	GR 288	BKT	17.00/2.0/17.00/1.7	520
15772663	20.5 - 25		20 PR	TL	Loader Plus	BKT	17.00/2.0	540
15772660	20.5 - 25		20 PR	TL	XL Grip	BKT	17.00/2.0	530
15772674	23.5 - 25	167 A8	20 PR	TL	GR 288	BKT	19.50/2.5	595
15772671	23.5 - 25		20 PR	TL	Loader Plus	BKT	19.50/2.5	600
15772670	23.5 - 25		20 PR	TL	XL Grip	BKT	19.50/2.5	600

¹ = empfohlene Felge / weitere zulässige Felgenbreiten

Alles auf einen Blick:

 Außen \varnothing in mm	 statischer Halbmesser in mm	 Abroll- umfang in mm	 Tragfähigkeit	 km/h	 Luftdruck in bar
1076	475	3130	5300/3250	10/50	4,50/3,50
1090	480	3295	5300/3250	10/50	4,50/3,50
1280	600	3943	2725	40	3,00
1348	598	3990	3650	40	3,50
1190	575	3600	5800/3550	10/50	4,50/3,50
1390	665	4205	6500/4250	10/50	3,00/2,50
1277	564	3720	3250	50	2,50
1270	572	3772	4750/2650	10/40	4,00/2,50
1285	573	3767	5600/3250	10/50	4,00/2,50
1485	682	4395	12500/7300	10/50	8,75/6,50
1347	597	3940	7300/3350	10/40	4,75/2,75
1348	599	3940	3650	50	2,20
1348	599	3940	4250	50	3,00
1330	596	3950	7300/3350	10/40	4,80/2,75
1345	622	3980	7300	10	4,75
1345	622	3980	7300/4250	10/50	4,75/3,00
1345	622	3980	10000/6150	10/50	7,00/5,75
1493	674	4445	8250/4000	10/40	2,25/3,50
1492	658	4340	5450	50	2,75/3,50
1480	656	4396	8250/4000	10/40	3,50/2,20
1480	656	4396	4500	40	2,75/4,50
1490	685	4410	9500	10	4,50
1485	682	4395	9500/6000	10/50	4,50/3,25
1610	708	4782	5450	40	2,50/3,75
1640	749	4855	10900	10	3,75
1625	742	4810	10900/7300	10/50	3,75/3,00

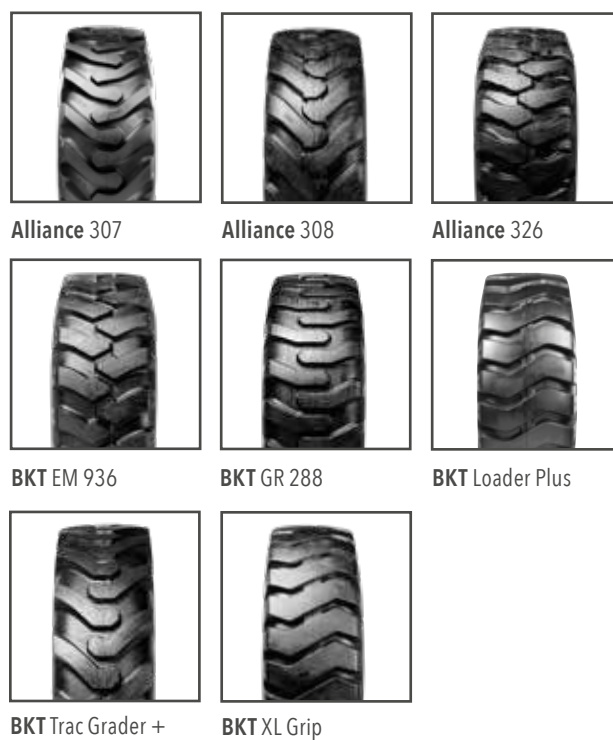

Alliance 307

Alliance 308

Alliance 326

BKT EM 936

BKT GR 288

BKT Loader Plus

BKT Trac Grader +

BKT XL Grip



EM Reifen Radial

Preise und Bestände finden Sie unter www.bohnenkamp.de/shop

Artikel-Nr.	Größe	Last-/ Speed-Index	TL/ TT	Profil	Marke	Star Rating	TRA Code	Felge ¹	Breite in mm
10000097	405/70 R 18	152 A2/149 A4	TL	BK Loader 53	BKT			13/12/14	407
15735233	405/70 R 20	155 A2/151 A4	TL	BK Loader 53	BKT			13/12/14	407
15785416	15.5 R 25	146 A8/169 A2	TL	Earthmax SR 22	BKT	*	G2 / L2	12.00/1.3	385
15785415	15.5 R 25	169 A2/160 B	TL	Earthmax SR 30	BKT	**/*	E3 / L3	12.00/1.3	397
11085100	15.5 R 25	176 A2/160 B	TL	MS300	Maxam	**	E3 / L3	12.00/1.3	388
15785436	17.5 R 25	167 B/182 A2	TL	Earthmax SR 22	BKT	**	E2 / L2	14.00/1.5	452
15785440	17.5 R 25	176 A2/167 B	TL	Earthmax SR 30	BKT	**/*	E3 / L3	14.00/1.5/14.00/1.3	446
15785435	17.5 R 25	176 A2	TL	Earthmax SR 51	BKT	*	L5	14.00/1.5/13.00/1.4	437
11085110	17.5 R 25	182 A2/167 B	TL	MS300	Maxam	**	E3 / L3	14.00/1.5	446
11085112	17.5 R 25	182 A2	TL	MS503	Maxam	**	L5T	14.00/1.5	433
15785471	20.5 R 25	177 B/193 A2	TL	Earthmax SR 22	BKT	**	E2 / L2	17.00/2.0	525
15785450	20.5 R 25	186 A2/177 B	TL	Earthmax SR 30	BKT	**/*	E3 / L3	17.00/2.0/17.00/1.7	529
15785455	20.5 R 25	186 A2/177 B	TL	Earthmax SR 31	BKT	**/*	E3 / L3	17.00/2.0	540
15785470	20.5 R 25	186 A2	TL	Earthmax SR 51	BKT	*	L5	17.00/2.0	539
11085150	20.5 R 25	193 A2/177 B	TL	MS300	Maxam	**	E3 / L3	17.00/2.0	520
10000754	20.5 R 25	193 A2/177 B	TL	MS302	Maxam	**	E3 / L3	17.00/2.0	521
11085152	20.5 R 25	193 A2	TL	MS503	Maxam	**	L5	17.00/2.0	532
15785511	23.5 R 25	201 A2/185 B	TL	Earthmax SR 22	BKT	**	E2 / L2	19.50/2.5	610
15785500	23.5 R 25	195 A2/185 B	TL	Earthmax SR 30	BKT	**/*	E3 / L3	19.50/2.5	612
15785502	23.5 R 25	195 A2/185 B	TL	Earthmax SR 31	BKT	**/*	E3 / L3	19.50/2.5	612
15785508	23.5 R 25	195 A2/185 B	TL	Earthmax SR 41	BKT	**/*	E4 / L4	19.50/2.5	615
15785505	23.5 R 25	195 A2	TL	Earthmax SR 51	BKT	*	L5	19.50/2.5	612
11085200	23.5 R 25	201 A2/185 B	TL	MS300	Maxam	**	E3 / L3	19.50/2.5	604
10000745	23.5 R 25	201 A2/185 B	TL	MS302	Maxam	**	E3 / L3	19.50/2.5	599
11085201	23.5 R 25	201 A2/185 B	TL	MS405 DUMPXTRA	Maxam	**	E4 / L4	19.50/2.5	609
11085203	23.5 R 25	201 A2	TL	MS503	Maxam	*	L5T	19.50/2.5	610
15785530	26.5 R 25	202 A2/193 B	TL	Earthmax SR 30	BKT	**/*	E3 / L3	22.00/3.0	689
15785531	26.5 R 25	202 A2/193 B	TL	Earthmax SR 31	BKT	**/*	E3 / L3	22.00/3.0	689
15785536	26.5 R 25	202 A2/193 B	TL	Earthmax SR 41	BKT	**/*	E4 / L4	22.00/3.0	678
15785541	26.5 R 25	209 A2	TL	Earthmax SR 50	BKT	**	L5	22.00/3.0	690
10000799	26.5 R 25	209 A2/193 B	TL	MS300	Maxam	**	E3 / L3	22.00/3.0	673
10000744	26.5 R 25	209 A2/193 B	TL	MS302	Maxam	**	E3 / L3	22.00/3.0	673
11085250	26.5 R 25	209 A2/193 B	TL	MS405 DUMPXTRA	Maxam	**	E4 / L4	22.00/3.0	679

¹ = empfohlene Felge / weitere zulässige Felgenbreiten

Alles auf einen Blick:

Außen ø in mm	statischer Halbmesser in mm	Abroll- umfang in mm	Tragfähigkeit	km/h	Luftdruck in bar
1045			3650/3250	10/20	3,75
1097	511	3339	3875/3450	10/20	5,50
1275	557	3841	5800/3000	10/40	5,00/3,00
1276	574	3809	5800/4500	10/50	5,25
1276	570	3793	7100/4500	10/50	6,50/5,25
1350	590	3950	8500/5450	10/50	6,50/5,25
1347	606	4021	7100/5450	10/50	5,00/5,25
1398	630	4110	7100	10	5,00
1345	594	3977	8500/5450	10/50	6,50/5,25
1408	647	4242	8500	10	6,50
1490	640	4315	11500/7300	10/50	6,50/5,25
1487	663	4439	9500/7300	10/50	4,50
1480	663	4449	9500/7300	10/50	5,00/5,25
1545	703	4650	9500	10	5,00
1486	671	4440	11500/7300	10/50	6,50/5,25
1493	693	4520	11500/7300	10/50	6,50/5,25
1547	704	4639	11500	10	6,50
1614	709	4863	14500/9250	10/50	6,50/5,25
1607	711	4797	12150/9250	10/50	4,50
1607	711	4797	12150/9250	10/50	5,00
1611	725	4790	12150/9250	10/50	5,00
1660	743	4882	12150	10	5,00
1604	701	4719	14500/9250	10/50	6,50/5,25
1613	707	4752	14500/9250	10/50	6,50/5,25
1623	728	4834	14500/9250	10/50	6,50/5,25
1668	750	4973	14500	10	6,50
1742	766	5200	15000/11500	10/50	5,00/5,25
1742	766	5200	15000/11500	10/50	5,00/5,25
1742	775	5150	15000/11500	10/50	4,50
1772	806	5334	18500	10	6,50
1745	751	5098	18500/11500	10/50	6,50/5,25
1742	784	5197	18500/11500	10/50	6,50/5,25
1765	770	5189	18500/11500	10/50	6,50/5,25



EM- und Baggereifen



EM Reifen Radial







Preise und Bestände finden Sie unter www.bohnenkamp.de/shop

Artikel-Nr.	Größe	Last-/ Speed-Index	TL/ TT	Profil	Marke	Star Rating	TRA Code	Felge ¹	Breite in mm
11085251	26.5 R 25	209 A2	TL	MS503	Maxam	**	L5	22.00/3.0	675
15785570	29.5 R 25	208 A2/200 B	TL	Earthmax SR 30	BKT	**/*	E3 / L3	25.00/3.5	765
15785563	29.5 R 25	208 A2/200 B	TL	Earthmax SR 41	BKT	**/*	E4 / L4	25.00/3.5	761
15785575	29.5 R 25	208 A2	TL	Earthmax SR 50	BKT	*	L5	25.00/3.5	775
10000747	29.5 R 25	216 A2/200 B	TL	MS302	Maxam	**	E3 / L3	25.00/3.5	747
10000752	29.5 R 25	216 A2/200 B	TL	MS405 DUMPXTRA	Maxam	**	E4 / L4	25.00/3.5	755
10000748	550/65 R 25	182 A2/172 B	TL	MS302	Maxam	*	E3 / L3	17.00/2.0	548
15785520	650/65 R 25	180 B	TL	Earthmax SR 35	BKT	**	E3	19.50/2.5	635
10000746	650/65 R 25	200 A2/180 B	TL	MS302	Maxam	**	E3 / L3	19.50/2.5	638
15785572	750/65 R 25	190 B/202 A2	TL	Earthmax SR 35	BKT	**/*	E3 / L3	24.00/3.0/22.00/3.0/25.00/3.0	740
15785559	750/65 R 25	202 A2/190 B	TL	Earthmax SR 412	BKT	**/*	E4 / L4	24.00/3.0/22.00/3.0/25.00/3.0	780
10000753	750/65 R 25	209 A2/190 B	TL	MS302	Maxam	**	E3 / L3	24.00/3.0	744

¹ = **empfohlene Felge** / weitere zulässige Felgenbreiten



Alles auf einen Blick:

 Außen ϕ in mm	 statischer Halbmesser in mm	 Abroll- umfang in mm	 Tragfähigkeit	 km/h	 Luftdruck in bar
1796	805	5347	18500	10	6,50
1861	818	5555	18000/14000	10/50	5,25
1861	830	5510	18000/14000	10/50	4,50
1901	862	5722	18000	10	5,00
1881	840	5590	22400/14000	10/50	6,50/5,25
1872	845	5592	22400/14000	10/50	6,50/5,25
1350	593	3981	8500/6300	10/50	4,75/4,25
1498	669	4493	8000	50	4,75
1479	619	4266	14000/8000	10/50	6,25/4,25
1601	715	4802	15000/10600	10/50	4,75/4,21
1602	715	4838	15000/10600	10/50	4,75
1596	664	4590	18500/10600	10/50	6,50/5,25



BKT Earthmax SR 30

BKT Earthmax SR 35

BKT Earthmax SR 41

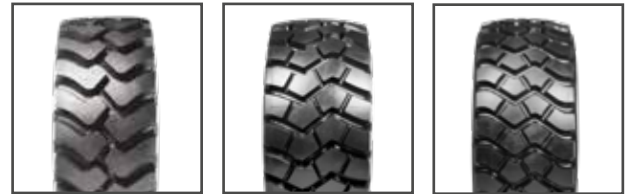

BKT Earthmax SR 50

BKT Earthmax SR 412

Maxam MS302



Maxam MS405
DUMPEXTRA

Maxam MS503



280

Industriereifen



INDUSTRIEREIFEN



SERVICE-PLUS BY BOHNENKAMP

Erhalten Sie direkten Zugriff
auf unseren Online-Shop



Industriereifen



Industriereifen

Preise und Bestände finden Sie unter www.bohnenkamp.de/shop



PR

TL/TT



Artikel-Nr.	Größe	PR	TL/TT	Profil	Marke	Felge ¹
15771061	18 x 7 - 8	16 PR	TT/Set	PL 801	BKT	4.33 /5.00
15771063	18 x 7 - 8	16 PR	TT/Set	Power Trax HD Forklift	BKT	4.33 /5.00
19271061	18 x 7 - 8	16 PR	TT/Set	K610 Kinetics	Kenda	4.33
15771053	5.00 - 8	10 PR	TT/Set	PL 801	BKT	3.00 /3.25
15771055	5.00 - 8	10 PR	TT/Set	Power Trax HD Forklift	BKT	3.00 /3.25
19271060	5.00 - 8	10 PR	TT/Set	K610 Kinetics	Kenda	3.00
15771080	21 x 8 - 9	14 PR	TT/Set	PL 801	BKT	6.00
15771085	21 x 8 - 9	16 PR	TT/Set	PL 801	BKT	6.00 /7.00
15771070	6.00 - 9	10 PR	TT/Set	PL 801	BKT	4.00
15771073	6.00 - 9	10 PR	TT/Set	Power Trax HD Forklift	BKT	4.00
19271050	6.00 - 9	12 PR	TT/Set	K610 Kinetics	Kenda	4.0
15771096	23 x 9 - 10	20 PR	TT/Set	Power Trax HD Forklift	BKT	6.50
19271071	23 x 9 - 10	20 PR	TT/Set	K610 Kinetics	Kenda	6.5
15771090	6.50 - 10	10 PR	TT/Set	PL 801	BKT	5.00
10000782	6.50 - 10	14 PR	TT/Set	Power Trax HD Forklift	BKT	5.00 /5.50
19271070	6.50 - 10	12 PR	TT/Set	K610 Kinetics	Kenda	5.0
19271087	23 x 10 - 12	20 PR	TT/Set	K610 Kinetics	Kenda	8.00
19271082	27 x 10 - 12	24 PR	TT/Set	K610 Kinetics	Kenda	8.00
15771104	27 x 10 - 12	16 PR	TT/Set	Power Trax HD Forklift	BKT	8.00
15771107	27 x 10 - 12	20 PR	TT/Set	Power Trax HD Forklift	BKT	8.00
15771100	7.00 - 12	14 PR	TT/Set	PL 801	BKT	5.00
15771103	7.00 - 12	14 Pr	TT/Set	Power Trax HD Forklift	BKT	5.00
19271080	7.00 - 12	16 PR	TT/Set	K610 Kinetics	Kenda	5.00
15771040	23 x 5 - 13	6 PR	TT	PL 801	BKT	3.75
15771172	10.00 - 15	24 PR	TT	Power Trax HD Forklift	BKT	7.50 /7.5
15771155	250 - 15	20 PR	TT/Set	PL 801	BKT	7.50 /7.0
15771158	250 - 15	20 PR	TT/Set	Power Trax HD Forklift	BKT	7.50 /7.0
19271096	250 - 15	20 PR	TT/Set	K610 Kinetics	Kenda	7.50
15771174	28 x 12.5 - 15	24 PR	TT	Power Trax HD Forklift	BKT	9.75
15771160	300 - 15	18 PR	TT/Set	PL 801	BKT	8.00
15771165	300 - 15	20 PR	TT/Set	Power Trax HD Forklift	BKT	8.00
19271097	300 - 15	20 PR	TT/Set	K610 Kinetics	Kenda	8.00
15771108	5.50 - 15	8 PR	TT	PL 801	BKT	5.50 /4.50
15771110	7.00 - 15	12 PR	TT/Set	PL 801	BKT	6.0 /5.50
19271092	7.00 - 15	14 PR	TT/Set	K610 Kinetics	Kenda	5.5
15771120	7.50 - 15	14 PR	TT/Set	PL 801	BKT	6.0
19271093	7.50 - 15	16 PR	TT/Set	K610 Kinetics	Kenda	6.0

¹ = empfohlene Felge / weitere zulässige Felgenbreiten

Alles auf einen Blick:

Breite in mm	Außen ø in mm	Tragfähigkeit Gabelstapler bei 25 km/h	
		Ladungsrad	Lenkungsrad
173	470	2145	1650
173	470	2145	1650
168	462	2063	1650
135	468	1415	1090
145	480	1415	1090
135	468	1363	1090
200	535	2535	1950
200	535	2755	2120
157	543	1715	1320
166	543	1715	1320
160	543	1813	1450
235	590	3445	2650
235	590	3313	2650
185	595	1950	1500
193	595	1800	2340
182	590	2063	1650
245	600	3625	2900
250	685	4845	3875
255	690	3900	3000
255	690	4615	3550
189	692	2755	2120
205	675	2755	2120
191	680	2800	2240
154	640	1495	1150
285	918	4800	6240
235	745	5040	3875
240	745	5040	3875
240	742	4844	3875
304	705	4745	3650
295	840	5850	4500
300	845	6340	4875
290	840	6250	5000
157	670	1950	1445
206	775	2835	2395
204	760	3150	2520
220	785	3430	2900
215	778	3750	3000



BKT PL 801



BKT Power Trax HD
Forklift



Kenda K610 Kinetics





Industriereifen

Preise und Bestände finden Sie unter www.bohnenkamp.de/shop

Artikel-Nr.	Größe	PR	TL/TT	Profil	Marke	Felge ¹
15771130	8.15 - 15	14 PR	TT/Set	PL 801	BKT	7.0
15771131	8.15 - 15	14 PR	TT/Set	Power Trax HD Forklift	BKT	7.00
19271094	8.15 - 15	14 PR	TT/Set	K610 Kinetics	Kenda	7.0
15771140	8.25 - 15	14 PR	TT/Set	PL 801	BKT	6.5/6.0/7.0
15771145	8.25 - 15	14 PR	TT/Set	Power Trax HD Forklift	BKT	6.50/7.0
19271095	8.25 - 15	14 PR	TT/Set	K610 Kinetics	Kenda	7.0
19271105	7.50 - 16	12 PR	TT/Set	K610 Kinetics	Kenda	6.0
15771178	9.00 - 20	16 PR	TT/Set	Power Trax HD Forklift	BKT	7.0/7.5
19271119	9.00 - 20	14 PR	TT/Set	K610 Kinetics	Kenda	7.0
19271120	10.00 - 20	16 PR	TT/Set	K610 Kinetics	Kenda	7.5
15771180	10.00 - 20	18 PR	TT/Set	Power Trax HD Forklift	BKT	7.5/7/8
19271121	11.00 - 20	18 PR	TT/Set	K610 Kinetics	Kenda	8.0
15771189	12.00 - 20	20 PR	TT/Set	Power Trax HD	BKT	8.50/9.00
15771193	12.00 - 20	28 PR	TT/Set	Power Trax HD	BKT	8.50/9.00
19271122	12.00 - 20	24 PR	TT/Set	K610 Kinetics	Kenda	8.5

¹ = **empfohlene Felge** / weitere zulässige Felgenbreiten



Alles auf einen Blick:

Breite in mm	Außen ø in mm	Tragfähigkeit Gabelstapler bei 25 km/h	
		Ladungsrad	Lenkungsrad
215	720	3900	3000
227	710	3770	2900
230	710	3750	3000
236	854	4225	3250
248	845	4225	3250
247	841	4063	3250
220	810	3488	2790
270	1050	6175	4750
265	1015	5625	4500
294	1080	6250	5000
285	1080	6890	5300
302	1110	7500	6000
320	1150	9230	7100
320	1150	9490	7300
325	1145	9338	7470



BKT PL 801



BKT Power Trax HD /
Power Trax HD Forklift



Kenda K610 Kinetics



286

Transport - Luftreifen

290

Heumaschinenreifen

294

Rasenreifen

296

Traktor Golf Rasenpflege



**LANDSCHAFTSPFLEGE,
HOF & FREIZEIT**



SERVICE-PLUS BY BOHNENKAMP

Erhalten Sie direkten Zugriff
auf unseren Online-Shop





Transport - Luftreifen





Preise und Bestände finden Sie unter www.bohnenkamp.de/shop

Artikel-Nr.	Größe	Last- / Speed-Index	PR	TL/TT	Profil	Marke	Felge ¹	Breite in mm
19110012	16 x 2,125		2 PR	TT	S-168	Deli	HB321x25	47
19200110	150 x 30		4 PR	TT/Set	R470 Road Star	Kenda	0.75	35
19211060	2.50 - 3		4 PR	TL	K301	Kenda	1.75	66
19110007	200 x 50		2 PR	TT/Set	S-379	Deli	1.25	48
19110009	200 x 50		2 PR	TT/Set	S-379	Deli	1.25	48
19110011	200 x 50		2 PR	TT/Set	S-379	Deli	1.25	48
19110014	2.80/2.50 - 4		4 PR	TT/Set	S-378	Deli	2.25/2.10	72
19110015	2.80/2.50 - 4		4 PR	TT/Set	S-302	Deli	2.25	72
19211094	2.80/2.50 - 4		4 PR	TL	K276	Kenda	2.25	75
19110017	2.50 - 4	39 A2	4 PR	TT/Set	S-379	Deli	2.10	68
10714612	2.50 - 4		4 PR	TT/Set	C202	Cheng Shin	2.10	64
19110024	3.00 - 4	46 A4	4 PR	TT/Set	S-379	Deli	2.50/2.10/2.25	93
19110022	3.00 - 4		4 PR	TL	S-310	Deli	2.50/2.10/2.25	86
19110020	3.00 - 4	52 A4	4 PR	TT/Set	S-310	Deli	2.50/2.10/2.25	86
19211072	3.00 - 4		6 PR	TT/Set	K373	Kenda	2.25	86
19110023	3.00 - 4	57 A4	6 PR	TT/Set	S-310	Deli	2.50/2.10/2.25	86
18692690	3.00 - 4		6 PR	TT	T991	Trelleborg	2.10/2.5	88
19111027	4.00 - 4	6 A6	4 PR	TL	S-310	Deli	2.50	110
19110028	4.00 - 4		4 PR	TT/Set	S-310	Deli	2.50/2.10	110
19110030	4.00 - 4	57 A4	4 PR	TT/Set	S-320	Deli	2.50/2.10	109
19110031	4.00 - 4	57 A2	4 PR	TT/Set	S-379	Deli	2.50/2.10	103
19211079	4.00 - 4	48 A4/59 A4*	4 PR	TL	K373	Kenda	3.0/2.25/2.10	121
19110029	4.00 - 4		6 PR	TT/Set	S-310	Deli	2.50/2.10	110
19211080	4.00 - 4		6 PR	TT/Set	K373	Kenda	2.50	104
19800306	4.00 - 4	77 A5	6 PR	TT/Set	IC 10	Continental	2.50	140
18692695	4.00 - 4		6 PR	TT	T991	Trelleborg	2.50	110
19110037	4.10/3.50 - 4		4 PR	TT/Set	S-356	Deli	2.50/2.10	94
19110041	4.10/3.50 - 4		4 PR	TL	S-389	Deli	2.50/2.10	94
19110040	4.10/3.50 - 4		4 PR	TT/Set	S-389	Deli	2.10	94
10714670	4.00 - 5		4 PR	TT/Set	C154	Cheng Shin	3.00	118
19110046	4.10/3.50 - 5		4 PR	TT/Set	S-356	Deli	3.00/2.10	96
19110045	4.10/3.50 - 5		4 PR	TL	S-389	Deli	2.75	96

* = höhere Tragfähigkeit für Einsatz auf gezogenen Fahrzeugen, niedrigere Tragfähigkeit für Einsatz auf angetriebenen Achsen

¹ = **empfohlene Felge** / weitere zulässige Felgenbreiten

Alles auf einen Blick:

 Außen ø in mm	 Tragfähigkeit in kg	 km/h	 Luftdruck in bar
408	55	20	2,80
156	50	40	6,20
211	110	16	3,50
194	75	20	1,80
194	75	20	1,80
194	75	20	1,80
227	135	20	3,50
227	135	20	3,50
226	134	16	3,50
228	136	10	3,50
219	65	16	3,50
267	170	20	4,20
265	200	20	4,20
265	200	20	4,20
269	195	16	5,20
265	230	20	5,20
260	135	30	5,00
320	250	30	4,10
320	245	30	4,20
312	230	20	3,50
310	230	10	3,50
306	180/243	20	4,10
320	280	30	5,20
306	280	16	5,20
318	412	25	8,00
310	190	30	4,21
272	160	20	3,50
272	160	20	3,50
275	160	16	3,50
330	145	16	3,40
298	175	20	3,50
298	175	20	3,50



Cheng Shin C154



Cheng Shin C202



Continental IC 10



Deli S-168



Deli S-302



Deli S-310



Deli S-320

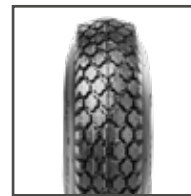

Deli S-356



Deli S-378

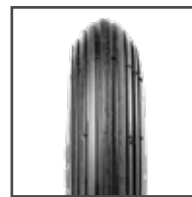

Deli S-379



Deli S-389

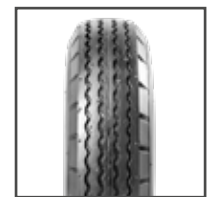

Kenda K276

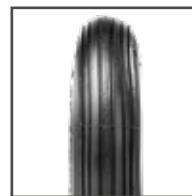

Kenda K301



Kenda K373

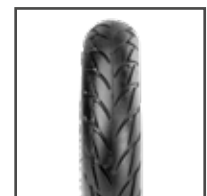

Kenda R470
Road Star



Trelleborg T991



Transport - Luftreifen





Preise und Bestände finden Sie unter www.bohnenkamp.de/shop

Artikel-Nr.	Größe	Last- / Speed-Index	PR	TL/ TT	Profil	Marke	Felge ¹	Breite in mm
19800046	2.50 - 6		4 PR	TT/Set	HF-216	Duro	1.75	66
19110060	3.50 - 6	52 A4	4 PR	TT/Set	S-379 K	Deli	2.50/2.10	91
19110061	3.50 - 6	52 A4	4 PR	TT/Set	S-379 K	Deli	2.50	91
19110066	4.00 - 6	57 A4	4 PR	TL	S-379	Deli	2.50	100
19110065	4.00 - 6	57 A4	4 PR	TT/Set	S-379	Deli	2.50	100
19110067	4.00 - 6	57 A4	4 PR	TT/Set	S-379	Deli	2.50	100
19211111	4.00 - 6	57 A4/68 A4*	6 PR	TT/Set	K311	Kenda	2.25/2.50	99
10714708	4.00 - 6		4 PR	TT/Set	C166	Cheng Shin	2.50	115
19110073	4.10/3.50 - 6		4 PR	TT/Set	S-356	Deli	2.50	94
19110072	4.10/3.50 - 6		4 PR	TL	S-389	Deli	2.50	94
19211118	4.10/3.50 - 6		4 PR	TT	K304	Kenda	2.50	86
18692012	4.10/3.50 - 6	57 J		TT	T533	Trelleborg	2.50	94
19110074	5.30/4.50 - 6		4 PR	TL	S-356	Deli	4.00/3.50	125
19110075	5.30/4.50 - 6		4 PR	TT/Set	S-356	Deli	4.00/3.50	125
10714775	2.50 - 8		4 PR	TT/Set	C177	Cheng Shin	1.50	69
19110004	2.25 - 8			TT/Set	S-115	Deli	1.75	50
19211159	2.25 - 8		2 PR	TT	K124	Kenda	1.75	47
19110102	2.50 - 8	24 A2	4 PR	TT/Set	S-359	Deli	1.50	59
19110101	3.00 - 8	32 A4	2 PR	TT	S-369	Deli	2.50	88
19110100	3.00 - 8	52 A4	4 PR	TT/Set	S-379	Deli	2.50	86
19110106	3.50 - 8	55 A4	4 PR	TT/Set	S-379	Deli	2.50	90
19110112	4.80/4.00 - 8	67 A4	4 PR	TL	S-379	Deli	2.50	104
19110110	4.80/4.00 - 8	67 A4	4 PR	TT/Set	S-379	Deli	2.50	104
19110109	4.80/4.00 - 8	67 A4	4 PR	TL	S-369	Deli	2.50	104
19110111	4.80/4.00 - 8	67 A4	4 PR	TT/Set	S-369	Deli	2.50	104
19110117	4.80/4.00 - 8	71 A4	6 PR	TT/Set	S-379	Deli	2.50	104
19110115	4.80/4.00 - 8		6 PR	TT/Set	S-359	Deli	2.50	104
19211165	4.80/4.00 - 8		6 PR	TT	K304	Kenda	3.75	108
19211170	4.80/4.00 - 8		6 PR	TL	K352	Kenda	2.50/3.75	104
18692050	4.00 - 8		8 PR	TT	T523	Trelleborg	2.50/3.00/3.75	123
19110122	5.00 - 8	112 A2	6 PR	TT	S-369	Deli	3.75	142
19211175	5.00 - 8	100 A2	6 PR	TT	K311	Kenda	3.00/3.50	148
19110121	5.00 - 8	126 A2/125 A3	10 PR	TT	S-369	Deli	3.75	142
19110160	6.00 - 9	118 A2	6 PR	TT	S-369	Deli	4.50	170
19211250	6.00 - 9		6 PR	TT	K311	Kenda	4.00	161
19211251	6.00 - 9		10 PR	TT	K311	Kenda	4.00	166
19110159	6.00 - 9	143 A2	14 PR	TT	S-369	Deli	4.50/4.00	170

* = höhere Tragfähigkeit für Einsatz auf gezogenen Fahrzeugen, niedrigere Tragfähigkeit für Einsatz auf angetriebenen Achsen

¹ = empfohlene Felge / weitere zulässige Felgenbreiten

Alles auf einen Blick:

			
Außen ø in mm	Tragfähigkeit in kg	km/h	Luftdruck in bar
278	150	10	4,90
331	200	20	3,40
333	200	20	3,50
355	230	20	3,50
355	230	20	3,50
355	230	20	3,50
350	230/315	20	6,00
361	230	25	3,40
325	205	20	3,50
325	205	20	3,50
315	200	16	3,50
315	230	100	4,50
368	260	20	4,50
368	260	20	4,50
335	77	16	3,40
315	40	40	2,80
304	40	40	2,80
323	90	10	3,50
368	112	20	2,50
367	200	20	4,20
380	218	20	3,50
409	307	20	3,50
409	307	20	3,50
409	307	20	3,50
409	307	20	3,50
414	345	20	5,00
414	340	20	5,00
417	340	16	4,10
413	340	10	4,21
418	670	25	9,00
462	1120	10	6,00
468	800	10	6,30
466	1700/1650	10/15	6,90
546	1320	10	5,00
526	1700	10	6,20
528	2100	10	6,90
543	2725	10	6,90

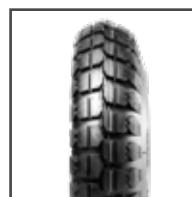

Cheng Shin C166



Cheng Shin C177



Deli S-115



Deli S-356



Deli S-359



Deli S-369

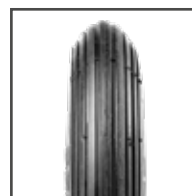

Deli S-379 / S-379 K



Deli S-389

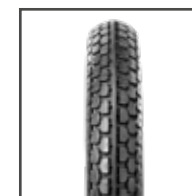

Duro HF-216



Kenda K124



Kenda K304

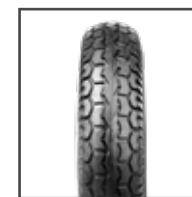

Kenda K311



Kenda K352



Trelleborg T523



Trelleborg T533



Heumaschinenreifen





Preise und Bestände finden Sie unter www.bohnenkamp.de/shop

Artikel-Nr.	Größe	Last-/ Speed-Index	PR	TL/ TT	Profil	Marke	Felge ¹	Breite in mm
19211071	3.00 - 4	34 A4/45 A4*	4 PR	TT	K406	Kenda	2.10	83
19110019	3.00 - 4	46 A6	4 PR	TT/Set	S-318	Deli	2.50/2.10/2.25	87
19211070	3.00 - 4	34 A4/45 A4*	4 PR	TT/Set	K406	Kenda	2.10	83
19211081	4.00 - 4	31 A4/42 A4*	4 PR	TT	K406	Kenda	3.00	105
19111061	4.00 - 4	43 A6	4 PR	TT/Set	S-318	Deli	2.50	104
19211082	4.00 - 4	31 A4/42 A4*	4 PR	TT/Set	K406	Kenda	3.00/2.50/2.1/2.25	105
12500100	105/75 - 4	42 A4		TL	Rib	Carlisle	2.50/2.75/3.25	104
19110035	11x7.00 - 4	60 A6	4 PR	TT	S-317	Deli	6.00	180
19110049	11x4.00 - 5	42 A6	4 PR	TL	S-317	Deli	3.00	104
19211116	3.50 - 6	33 A4/44 A4*	4 PR	TT	K406	Kenda	2.50	95
19111065	3.50 - 6	45 A6	4 PR	TT/Set	S-318	Deli	2.50	96
19211117	3.50 - 6	33 A4/44 A4*	4 PR	TT/Set	K406	Kenda	2.50/3.00	95
15710320	13x5.00 - 6	48 A6/53 A3	4 PR	TL	LG RIB	BKT	3.50	127
19110082	13x5.00 - 6	52 A6	4 PR	TT/Set	S-317	Deli	3.50	124
19110088	13x6.50 - 6	55 A6	4 PR	TT/Set	S-317	Deli	4.50	158
12500129	165/55 - 6	55 A4	4 PR	TL	Rib	Carlisle	4.50	151
15710326	15x6.00 - 6	57 A6/61 A3	4 PR	TL	LG RIB	BKT	4.50	152
19110090	15x6.00 - 6	61 A6	4 PR	TT/Set	S-317	Deli	4.50	154
19211134	15x6.00 - 6	47 F	4 PR	TL	K401Y	Kenda	4.50	157
19110096	15x6.00 - 6	70 A6	6 PR	TL	S-317	Deli	4.50	154
19110091	15x6.00 - 6	70 A6	6 PR	TT/Set	S-317	Deli	4.50	154
12500148	155/70 - 6	70 A6	6 PR	TT/Set	Farm Specialist Implement	Carlisle	4.50	157
18692227	15x6.00 - 6		6 PR	TT	T510	Trelleborg	4.50	162
19110093	15x6.00 - 6	84 A6	10 PR	TT/Set	S-317	Deli	4.50	154
19110089	220/50 - 6	62 A8/73 A8*	6 PR	TT/Set	S-317	Deli	7.00	220
18693280	220/50 - 6	73 A8		TT/Set	T510	Trelleborg	7.00	222
19111071	3.50 - 8	51 A6	4 PR	TT/Set	S-318	Deli	2.50	96
19211160	3.50 - 8	38 A4/49 A4*	4 PR	TT/Set	K406	Kenda	2.50	96
19110123	4.80/4.00 - 8	43 A6	4 PR	TT/Set	S-318	Deli	2.50/3.00	110
19211167	4.80/4.00 - 8	44 A4/55 A4*	4 PR	TT/Set	K406	Kenda	2.50/3.75/3.00	110
19110131	16x6.50 - 8	64 A6	4 PR	TL	S-317	Deli	5.375	168
19110125	16x6.50 - 8	64 A6	4 PR	TT/Set	S-317	Deli	5.375	168
19211178	16x6.50 - 8	58 F	4 PR	TL	K401Y	Kenda	5.375	166
15710379	16x6.50 - 8	68 A6/72 A3	6 PR	TL	LG RIB	BKT	5.375	170
19110128	16x6.50 - 8	72 A6	6 PR	TT/Set	S-317	Deli	5.375	168
12500257	165/60 - 8	64 A6	6 PR	TT/Set	Farm Specialist Implement	Carlisle	5.375	162
19110127	16x6.50 - 8	84 A6	10 PR	TT/Set	S-317	Deli	5.375	168
19211182	16x6.50 - 8	71 A4/82 A4*	10 PR	TT/Set	K401H	Kenda	5.375	167
12500256	165/60 - 8	85 A6	10 PR	TT/Set	Farm Specialist Implement	Carlisle	5.375	162

* = höhere Tragfähigkeit für Einsatz auf gezogenen Fahrzeugen, niedrigere Tragfähigkeit für Einsatz auf angetriebenen Achsen

¹ = **empfohlene Felge** / weitere zulässige Felgenbreiten

Alles auf einen Blick:

 Außen ø in mm	 Tragfähigkeit in kg	 km/h	 Luftdruck in bar
260	118/165	20	3,30
267	170	30	3,30
260	118/165	20	3,30
307	109/150	20	2,75
314	155	30	2,80
307	109/150	20	2,75
264	150	20	3,20
275	250	30	3,10
288	150	30	3,20
332	115/160	20	3,00
338	165	30	3,00
332	115/160	20	3,00
325	180/206	30/15	2,80
332	200	30	2,80
336	218	30	1,90
329	218	20	1,90
365	230/257	30/15	2,10
360	257	30	2,10
368	175	80	2,40
363	335	30	3,10
363	335	30	3,10
360	335	30	3,31
366	335	30	3,30
366	500	30	5,20
382	265/365	40	2,80
370	365	40	2,80
390	195	30	3,00
388	132/185	20	2,75
418	155	30	2,10
425	160/218	20	2,80
418	280	30	1,90
418	280	30	1,90
405	236	80	2,40
408	315/355	30/15	2,90
420	355	30	2,90
406	280	30	3,00
418	500	30	4,80/5,50
398	345/475	20	4,90
406	515	30	5,10



BKT LG RIB

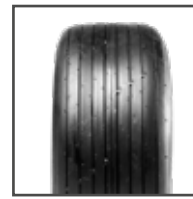

Carlisle Farm
Specialist Implement



Carlisle Rib



Deli S-317

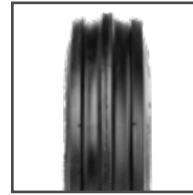

Deli S-318



Kenda K401H



Kenda K401Y

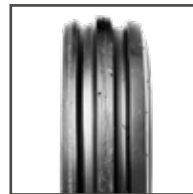

Kenda K406



Trelleborg T510



Heumaschinenreifen

Preise und Bestände finden Sie unter www.bohnenkamp.de/shop





Artikel-Nr.	Größe	Last-/ Speed-Index	PR	TL/ TT	Profil	Marke	Felge ¹	Breite in mm
19800330	16x9.50 - 8	76 B	6 PR	TT	SE-317S	Starco	7.00	224
10711477	16x9.50 - 8	75 B	6 PR	TT/Set	C737	Cheng Shin	7.00	217
19110142	18x8.50 - 8	74 A6	4 PR	TT/Set	S-317	Deli	7.00	216
15711240	18x8.50 - 8	85 A8	6 PR	TL	Rib 774 (A)	BKT	7.00	225
19211203	18x8.50 - 8	81 A4/69 A4*	6 PR	TL	K401H	Kenda	7.00	218
12500265	215/60 - 8	82 A6	6 PR	TT/Set	Farm Specialist Implement	Carlisle	7.00	213
19211212	18x9.50 - 8	70 A4/81 A4*	4 PR	TL	K401	Kenda	7.00	231
19211230	AT 21x12 - 8	40 F	4 PR	TL	K401 Beach Racer	Kenda	8.5/9.0/9.5/10.0	289
15710435	20x10.00 - 10	82 A6/86 A3	4 PR	TL	LG RIB	BKT	8.00/7.00	236
19110175	20x10.00 - 10	86 A6	4 PR	TL	S-317	Deli	8.50	241
15711310	300/65 - 12	116 A8	8 PR	TL	Rib 775	BKT	9.0/8.5	305
19111118	200/60 - 14.5	106 A8/102 B	10 PR	TL	SG-319	Deli	6.75	205

* = höhere Tragfähigkeit für Einsatz auf gezogenen Fahrzeugen, niedrigere Tragfähigkeit für Einsatz auf angetriebenen Achsen

¹ = **empfohlene Felge** / weitere zulässige Felgenbreiten



Alles auf einen Blick:

 Außen ø in mm	 Tragfähigkeit in kg	 km/h	 Luftdruck in bar
416	400	50	2,30
414	387	50	3,10
444	375	30	1,50
460	515	40	3,00
455	462/325	20	2,30
451	475	30	2,30
457	335/462	20	1,65
547	140	80	0,35
498	475/530	30/15	1,50
498	530	30	1,50
685	1250	40	2,60
616	950/850	40/50	4,80

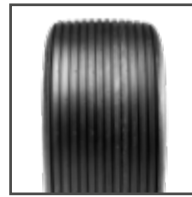

BKT LG RIB



BKT Rib 774 (A)



BKT Rib 775



Carlisle Farm
Specialist Implement



Cheng Shin C737



Deli S-317

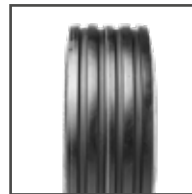

Deli SG-319

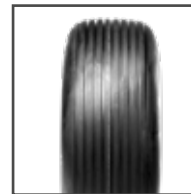

Kenda K401 / K401H /
K401 Beach Racer



Starco SE-317S





Rasenreifen





Preise und Bestände finden Sie unter www.bohnenkamp.de/shop

Artikel-Nr.	Größe	Last-/ Speed-Index	PR	TL/ TT	Profil	Marke	Felge ¹	Breite in mm
19211088	9x3.50 - 4	19 A4/29 A4*	4 PR	TL	K372 Turf Max	Kenda	2.10	94
10711290	9x3.50 - 4		4 PR	TL	C203	Cheng Shin	2.65	92
18692698	100/100 - 4	60 A8		TT	T539	Trelleborg	2.50	98
19110039	4.10/3.50 - 4	32 A6/44 A6*	4 PR	TL	S-366	Deli	2.50	95
19211083	4.10/3.50 - 4	32 A4/43 A4*	4 PR	TL	K358 Turf Rider	Kenda	2.50	100
19211085	4.10/3.50 - 4	32 A4/43 A4*	4 PR	TL	K500 Super Turf	Kenda	2.75	95
10711270	4.10/3.50 - 4	71 A3	4 PR	TL	C165	Cheng Shin	2.65	97
18692170	4.10/3.50 - 4		6 PR	TT	T539	Trelleborg	2.10	89
12500091	125/70 - 4	27 A4	2 PR	TL	Turf Saver	Carlisle	2.50	105
19110034	11x4.00 - 4	31 A6/43 A6*	4 PR	TL	S-365	Deli	2.75	102
19211092	11x4.00 - 4	30 A4/41 A4*	4 PR	TL	K358 Turf Rider	Kenda	2.75/2.10	105
19211089	11x4.00 - 4	30 A4/41 A4*	4 PR	TL	K500 Super Turf	Kenda	2.75	103
10711300	11x4.00 - 4		4 PR	TL	C165 S	Cheng Shin	3.25	107
12500087	12x5.00 - 4	38 A4	2 PR	TL	Turf Pro	Carlisle	2.50/3.50	119
12500111	11x4.00 - 5	26 A4	2 PR	TL	Turf Trac R/S	Carlisle	3.00	101
15710310	11x4.00 - 5	39 A6	4 PR	TL	LG 306	BKT	3.00	104
19110050	11x4.00 - 5	30 A6/42 A6*	4 PR	TL	S-365	Deli	3.00	105
19211105	11x4.00 - 5	30 A4/41 A4*	4 PR	TL	K358 Turf Rider	Kenda	3.00/2.50	99
19211106	11x4.00 - 5	30 A4/41 A4*	4 PR	TT/Set	K358 Turf Rider	Kenda	3.00	99
19211104	11x4.00 - 5	30 A4/41 A4*	4 PR	TL	K500 Super Turf	Kenda	3.00	100
19110077	140 - 6	55 A6/67 A6*	6 PR	TL	S-374	Deli	4.50	129
18692200	140 - 6	48 A6/60 A6*	6 PR	TT	T539	Trelleborg	4.50	135
19211140	13x5.00 - 6	26 A4/37 A4*	2 PR	TL	K383 Power Turf	Kenda	3.50	115
15710323	13x5.00 - 6	52 A3/48 A6	4 PR	TL	LG 306	BKT	3.50	127
19110081	13x5.00 - 6	40 A6/52 A6*	4 PR	TL	S-365	Deli	3.50	124
19211120	13x5.00 - 6	40 A4/51 A4*	4 PR	TL	K358 Turf Rider	Kenda	3.50	120
19211119	13x5.00 - 6	40 A4/51 A4*	4 PR	TT/Set	K358 Turf Rider	Kenda	3.50	130
19211123	13x5.00 - 6	40 A4/51 A4*	4 PR	TL	K500 Super Turf	Kenda	3.50	122
10711384	13x5.00 - 6	48 A6	4 PR	TL	C9266	Cheng Shin	3.50	117
18692221	13x5.00 - 6	52 A6	4 PR	TL	T539	Trelleborg	3.50	117
19211121	13x5.00 - 6	49 A4/60 A4*	6 PR	TL	K358 Turf Rider	Kenda	3.50	121
19110085	13x6.50 - 6	43 A6/55 A6*	4 PR	TL	S-365	Deli	4.50	160
19110086	13x6.50 - 6	43 A6/55 A6*	4 PR	TT/Set	S-365	Deli	4.50	160
19800321	13x6.50 - 6	42 A4/53 A4*	4 PR	TL	K358 Turf Rider	Kenda	4.50	154
19211125	13x6.50 - 6	42 A4/53 A4*	4 PR	TT/Set	K358 Turf Rider	Kenda	4.50	154
12500133	170/55 - 6	55 A4	4 PR	TL	Turf Saver	Carlisle	4.50	161
19110087	13x6.50 - 6	48 A6/60 A6*	6 PR	TL	S-365	Deli	4.50	158
19211127	14x5.50 - 6	28 A4/39 A4*	2 PR	TL	K383 Power Turf	Kenda	3.50	127
19211128	15x5.50 - 6	58 A4/69 A4*	6 PR	TL	K500 Super Turf	Kenda	4.00	142
19211129	15x6.00 - 6	33 A4/45 A4*	2 PR	TL	K383 Power Turf	Kenda	4.50	152

* = höhere Tragfähigkeit für Einsatz auf gezogenen Fahrzeugen, niedrigere Tragfähigkeit für Einsatz auf angetriebenen Achsen

¹ = **empfohlene Felge** / weitere zulässige Felgenbreiten

Alles auf einen Blick:

 Außen ø in mm	 Tragfähigkeit in kg	 km/h	 Luftdruck in bar
229	77,5/103	20	3,40
232	73	30	3,50
304	250	40	6,00
275	112/160	30	3,50
271	112/155	20	3,50
272	112/155	20	3,50
259	345	15	3,40
272	210	25	6,90
285	98	20	1,50
290	109/155	30	3,20
290	106/145	20	3,20
271	106/145	20	2,10
290	102	16	1,60
290	132	20	1,50
270	95	20	1,50
272	136	30	3,20
288	106/150	30	3,20
272	106/145	20	3,20
272	106/145	20	3,20
276	106/145	20	3,20
321	218/307	30	5,90
321	180/250	30	5,90
320	95/128	20	1,40
325	200/180	15/30	2,80
336	140/200	30	2,80
325	140/195	20	2,80
328	140/195	20	2,80
322	140/195	20	2,80
320	180	30	2,50
322	200	30	2,80
330	185/250	20	4,20
336	155/218	30	1,90
336	155/218	30	1,90
328	150/206	20	1,90
328	150/206	20	1,90
340	218	20	1,90
336	180/250	30	2,60
345	100/136	20	1,00
366	236/325	20	3,20
377	115/165	20	1,00



BKT LG 306



Carlisle Turf Pro

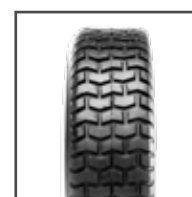

Carlisle Turf Saver



Carlisle Turf Trac R/S



Cheng Shin C165 /
C165 S



Cheng Shin C203

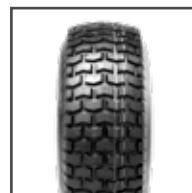

Cheng Shin C9266

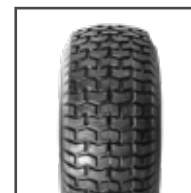

Deli S-365

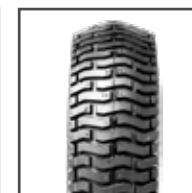

Deli S-366

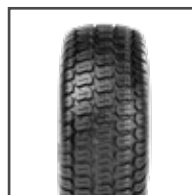

Deli S-374



Kenda K358
Turf Rider

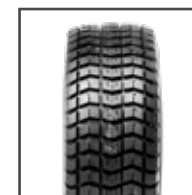

Kenda K372
Turf Max



Kenda K383
Power Turf



Kenda K500
Super Turf



Trelleborg T539



Rasenreifen





Preise und Bestände finden Sie unter www.bohnenkamp.de/shop

Artikel-Nr.	Größe	Last-/ Speed-Index	PR	TL/ TT	Profil	Marke	Felge ¹	Breite in mm
12500163	15x6.00 - 6	45 A4	2 PR	TL	Turf Saver	Carlisle	4.50	161
12500127	170/65 - 6	45 A4	2 PR	TL	Turf Saver Plus	Carlisle	4.50	165
15710328	15x6.00 - 6	57 A6	4 PR	TL	LG 306	BKT	4.50	152
19110092	15x6.00 - 6	49 A6/61 A6*	4 PR	TL	S-365	Deli	4.50	162
19110098	15x6.00 - 6	49 A6/61 A6*	4 PR	TT/Set	S-365	Deli	4.50	162
19211132	15x6.00 - 6	49 A4/60 A4*	4 PR	TL	K358 Turf Rider	Kenda	4.50	158
19211130	15x6.00 - 6	49 A4/60 A4*	4 PR	TT/Set	K358 Turf Rider	Kenda	4.50	158
19211135	15x6.00 - 6	49 A4/60 A4*	4 PR	TL	K500 Super Turf	Kenda	4.50	158
19211137	15x6.00 - 6	49 A4/60 A4*	4 PR	TL	K505	Kenda	4.50	157
12500160	15x6.00 - 6	61 A4	4 PR	TL	Turf Master	Carlisle	4.50	152
18692225	15x6.00 - 6	61 A4	4 PR	TL	T539	Trelleborg	4.50	155
19110095	15x6.00 - 6	58 A6/70 A6*	6 PR	TL	S-365	Deli	4.50	162
19110097	15x6.00 - 6	58 A6/70 A6*	6 PR	TT/Set	S-365	Deli	4.50	162
19211133	15x6.00 - 6	55 A4/67 A4*	6 PR	TL	K358 Turf Rider	Kenda	4.5	152
19211131	15x6.00 - 6	55 A4/67 A4*	6 PR	TT/Set	K358 Turf Rider	Kenda	4.5	155
19211136	15x6.00 - 6	55 A4/67 A4*	6 PR	TL	K500 Super Turf	Kenda	4.5	156
10711394	15x6.00 - 6	67 A8	6 PR	TL	C165	Cheng Shin	4.50	165
12500149	210/70 - 6	49 A4	4 PR	TT	Turf Glide	Carlisle	3.25	181
19211169	4.80/4.00 - 8	54 A4/66 A4*	4 PR	TL	K358 Turf Rider	Kenda	2.50	126
10711452	4.80/4.00 - 8	74 A4	6 PR	TL	C165	Cheng Shin	3.75	125
19800469	13x5.00 - 8	28 A4/28 A4*	2 PR	TL	SE-373A Turf Grip	Starco	4.00	122
12500306	170/55 - 8	47 A4	2 PR	TL	Turf Master	Carlisle	5.375	156
19800471	160/50 - 8	38 A4/50 A4*	4 PR	TL	SE-373A Turf Grip	Starco	4.375	142
19800470	160/50 - 8	38 A4/50 A4*	4 PR	TL	SE-600 Turf Grip Pro	Starco	4.375	142
19800403	16x6.00 - 8	42 A4/42 A4*	2 PR	TL	SE-373A Turf Grip	Starco	4.375	156
12500303	16x6.50 - 8	46 A4	2 PR	TL	Turf Saver	Carlisle	5.375	167
12500264	16x6.50 - 8	49 A4	2 PR	TL	Turf Master	Carlisle	5.375	162
15710385	16x6.50 - 8	64 A3/60 A6	4 PR	TL	LG 306	BKT	5.375	170
19110126	16x6.50 - 8	52 A6/64 A6*	4 PR	TL	S-365	Deli	5.375	170
19110132	16x6.50 - 8	52 A6/64 A6*	4 PR	TT/Set	S-365	Deli	5.375	170
19211179	16x6.50 - 8	52 A4/63 A4*	4 PR	TL	K358 Turf Rider	Kenda	5.375	164
19211180	16x6.50 - 8	52 A4/63 A4*	4 PR	TT/Set	K358 Turf Rider	Kenda	5.375	164
19211185	16x6.50 - 8	52 A4/63 A4*	4 PR	TL	K500 Super Turf	Kenda	5.375	168
19211176	16x6.50 - 8	52 A4/63 A4*	4 PR	TL	K505	Kenda	5.375	166
19211144	165/65 - 8	58 G	4 PR	TL	K399 Pro Tour	Kenda	5.375	167
10711460	16x6.50 - 8	60 A6	4 PR	TL	C165 S	Cheng Shin	5.375	165
15710384	16x6.50 - 8	72 A3/68 A6	6 PR	TL	LG 306	BKT	5.375	170
19110130	16x6.50 - 8	60 A6/72 A6*	6 PR	TL	S-365	Deli	5.375	170
19110083	16x6.50 - 8	60 A6/72 A6*	6 PR	TT/Set	S-365	Deli	5.375	170

* = höhere Tragfähigkeit für Einsatz auf gezogenen Fahrzeugen, niedrigere Tragfähigkeit für Einsatz auf angetriebenen Achsen

¹ = **empfohlene Felge** / weitere zulässige Felgenbreiten

Alles auf einen Blick:

 Außen ø in mm	 Tragfähigkeit in kg	 km/h	 Luftdruck in bar
364	165	20	1,00
381	165	20	1,00
365	230	30	2,10
378	185/257	30	2,10
378	185/257	30	2,10
372	185/250	20	2,10
372	185/250	20	2,10
374	185/250	20	2,10
369	185/250	20	2,10
366	257	20	2,10
366	257	30	2,00
380	236/335	30	3,10
380	236/335	30	3,10
362	218/307	20	2,80
366	218/307	20	2,80
372	218/307	20	3,20
386	307	40	2,50
448	185	20	1,40
416	212/300	20	2,90
412	375	20	2,50
330	100	20	0,80
381	175	20	1,00
364	132/190	20	1,30
364	132/190	20	1,30
394	150	20	0,80
413	170	20	0,82
411	185	20	0,97
408	280/250	15/30	1,90
410	200/280	30	1,90
410	200/280	30	1,90
404	200/272	20	2,00
404	200/272	20	2,00
402	200/272	20	2,00
406	200/272	20	2,00
415	236	90	2,40
419	250	30	1,90
408	355/315	15/30	2,90
412	250/355	30	2,90
412	250/355	30	2,90



BKT LG 306

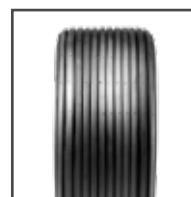

Carlisle Turf Glide

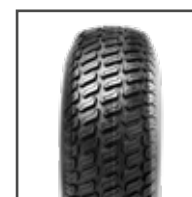

Carlisle Turf Master

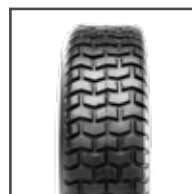

Carlisle Turf Saver /
Turf Saver Plus

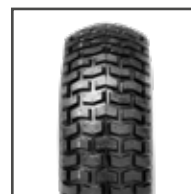

Cheng Shin C165 /
C165 S

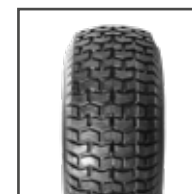

Deli S-365

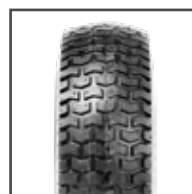

Kenda K358
Turf Rider

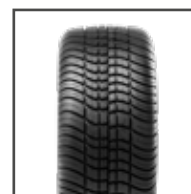

Kenda K399
Pro Tour



Kenda K500
Super Turf



Kenda K505



Starco SE-373A
Turf Grip



Starco SE-600
Turf Grip Pro

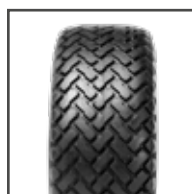

Trelleborg T539



Rasenreifen





Preise und Bestände finden Sie unter www.bohnenkamp.de/shop

Artikel-Nr.	Größe	Last-/ Speed-Index	PR	TL/ TT	Profil	Marke	Felge ¹	Breite in mm
19211158	16x6.50 - 8	59 A4/70 A4*	6 PR	TL	K358 Turf Rider	Kenda	5.375/5.50	169
19211181	16x6.50 - 8	59 A4/70 A4*	6 PR	TT/Set	K358 Turf Rider	Kenda	5.375/5.50	169
19211186	16x6.50 - 8	59 A4/70 A4*	6 PR	TL	K500 Super Turf	Kenda	5.375	180
18692330	16.5x6.5 - 8	64 J		TL	T539	Trelleborg	5.375	165
19800468	170/60 - 8	59 A8/46 A8*	4 PR	TL	SE-600 Turf Grip Pro	Starco	5.50	168
19211187	16x7.50 - 8	42 A4/54 A4*	2 PR	TL	K383 Power Turf	Kenda	5.375	179
12500289	16x7.50 - 8	55 A4	2 PR	TL	Turf Saver	Carlisle	5.375	177
19110135	16x7.50 - 8	58 A3/70 A3*	4 PR	TL	S-373A	Deli	5.375	174
19211189	16x7.50 - 8	53 A4/64 A4*	4 PR	TL	K358 Turf Rider	Kenda	5.375	188
19211190	16x7.50 - 8	53 A4/64 A4*	4 PR	TL	K500 Super Turf	Kenda	5.375	184
12500291	16x7.50 - 8	67 A4	4 PR	TL	Turf Master	Carlisle	5.375/5.50	178
19211191	16x7.50 - 8	62 A4/73 A4*	6 PR	TL	K500 Super Turf	Kenda	5.375	185
19211188	16x7.50 - 8	67 A6/78 A6*	6 PR	TL	K383 Power Turf	Kenda	5.50	188
19211240	190 - 8	79 A4/90 A4*	8 PR	TL	K383 Power Turf	Kenda	5.50	185
19211242	200/55 - 8	41 A4/52 A4*	2 PR	TL	K383 Power Turf	Kenda	5.375	185
19800473	200/65 - 8	58 A8/70 A8*	4 PR	TL	SE-600 Turf Grip Pro	Starco	5.50	200
19110138	18x6.50 - 8	59 A6/71 A6*	4 PR	TL	S-365	Deli	5.375	166
19211196	18x6.50 - 8	59 A4/70 A4*	4 PR	TL	K367 Grasshopper	Kenda	5.375	180
19211195	18x6.50 - 8	59 A4/70 A4*	4 PR	TL	K500 Super Turf	Kenda	5.375	170
10711466	18x6.50 - 8		4 PR	TL	C9266	Cheng Shin	5.00	175
19211194	18x6.50 - 8	66 A4/77 A4*	6 PR	TL	K500 Super Turf	Kenda	5.375	170
19211193	18x6.50 - 8	66 A4/77 A4*	6 PR	TL	K389 Hole-N-One	Kenda	5.00	163
12510117	165/70 - 8	71 A4	4 PR	TL	Turf Master	Carlisle	5.375	163
15710387	18x7.00 - 8	76 A6	6 PR	TL	TR 360	BKT	5.50	180
19211197	18x7.00 - 8	69 A4/79 A4*	6 PR	TL	K384	Kenda	5.50	182
19211198	18x7.50 - 8	61 A4/72 A4*	4 PR	TL	K500 Super Turf	Kenda	5.375	192
12500300	18x8.50 - 8	58 A4	2 PR	TL	Turf Saver	Carlisle	7.00	208
12500307	18x8.50 - 8	58 A4	2 PR	TL	Turf Saver Plus	Carlisle	7.00	208
15710395	18x8.50 - 8	74 A3/70 A6	4 PR	TL	LG 306	BKT	7.00	215
15710390	18x8.50 - 8	70 A6	4 PR	TL	GF 304	BKT	7.00	216
19110143	18x8.50 - 8	62 A6/74 A6*	4 PR	TL	S-366 K	Deli	7.00	222
19211202	18x8.50 - 8	61 A4/73 A4*	4 PR	TL	K358 Turf Rider	Kenda	7.00	215
19211206	18x8.50 - 8	61 A4/73 A4*	4 PR	TL	K500 Super Turf	Kenda	7.00	216
19211234	18x8.50 - 8	61 A4/73 A4*	4 PR	TL	K505	Kenda	7.00	210
19211204	18x8.50 - 8	61 A4/73 A4*	4 PR	TL	K389 Hole-N-One	Kenda	7.00	216
12500324	18x8.50 - 8	74 A4	4 PR	TL	Turf Saver	Carlisle	7.00	207
12500319	215/60 - 8	74 A4	4 PR	TL	Turf Master	Carlisle	7.00	206
12500308	18x18.50 - 8	74 A4	4 PR	TL	Multi Trac C/S	Carlisle	7.00	210
12500325	18x8.50 - 8	74 A4	4 PR	TL	Turf Trac R/S	Carlisle	7.00	206
18692380	18x8.50 - 8	74 A6	4 PR	TL	T539	Trelleborg	7.00/6.50	222

* = höhere Tragfähigkeit für Einsatz auf gezogenen Fahrzeugen, niedrigere Tragfähigkeit für Einsatz auf angetriebenen Achsen

¹ = **empfohlene Felge** / weitere zulässige Felgenbreiten

Alles auf einen Blick:

 Außen ø in mm	 Tragfähigkeit in kg	 km/h	 Luftdruck in bar
407	243/335	20	2,90
407	243/335	20	3,00
400	243/335	20	2,90
409	280	100	3,10
406	243/170	40	1,70
397	150/212	20	0,85
416	218	20	0,83
396	236/335	15	1,70
411	206/280	20	1,70
414	206/280	20	1,70
419	307	20	1,60
428	265/365	20	2,20
414	307/425	30	3,10
420	437/600	20	6,00
428	145/200	20	0,65
454	236/335	40	1,20
448	243/345	30	1,90
465	243/335	20	2,00
452	243/335	20	2,00
441	345	16	1,90
460	300/412	20	2,80
453	300/412	20	2,76
442	345	20	2,00
460	400	30	3,10
457	325/437	20	3,20
458	257/355	20	1,70
455	236	20	0,68
470	236	20	0,70
450	375/335	15/30	1,50
460	335	30	1,50
462	265/375	30	1,50
456	257/365	20	1,50
452	257/365	20	1,50
450	257/365	20	1,50
448	257/365	20	1,50
463	375	20	1,50
464	375	20	1,50
455	375	20	1,60
450	375	20	1,50
472	375	30	1,50



BKT GF 304



BKT LG 306



BKT TR 360



Carlisle Multi Trac C/S



Carlisle Turf Master



Carlisle Turf Saver /
Turf Saver Plus



Carlisle Turf Trac R/S

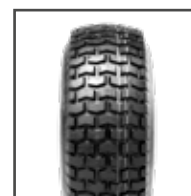

Cheng Shin C9266

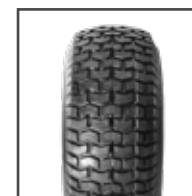

Deli S-365



Deli S-366 K



Deli S-373A

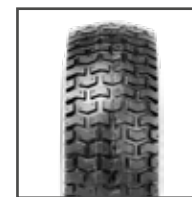

Kenda K358
Turf Rider



Kenda K367
Grasshopper



Kenda K383
Power Turf



Kenda K384



Kenda K389
Hole-N-One



Kenda K500
Super Turf



Kenda K505



Starco SE-600
Turf Grip Pro

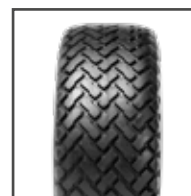

Trelleborg T539



Rasenreifen





Preise und Bestände finden Sie unter www.bohnenkamp.de/shop

Artikel-Nr.	Größe	Last-/ Speed-Index	PR	TL/ TT	Profil	Marke	Felge ¹	Breite in mm
15710396	18x8.50 - 8	82 A3/78 A6	6 PR	TL	LG 306	BKT	7.00	215
19211201	18x8.50 - 8	69 A4/81 A4*	6 PR	TL	K358 Turf Rider	Kenda	7.00	214
19211205	18x8.50 - 8	69 A4/81 A4*	6 PR	TL	K500 Super Turf	Kenda	7.00	217
19211207	18x8.50 - 8	69 A4/81 A4*	6 PR	TL	K389 Hole-N-One	Kenda	7.00	216
10711472	18x8.50 - 8		6 PR	TL	C165 S	Cheng Shin	7.00	218
19211209	18x8.50 - 8	76 A4/88 A4*	8 PR	TL	K505	Kenda	7.00	211
12598003	18x8.50 - 8	89 A4	8 PR	TL	Multi Trac C/S	Carlisle	7.00	211
12500302	250/50 - 8	68 A4	2 PR	TL	Turf Saver	Carlisle	7.00	241
19110146	18x9.50 - 8	70 A6/82 A6*	4 PR	TL	S-366 K	Deli	7.00	234
19211211	18x9.50 - 8	70 A4/81 A4*	4 PR	TL	K358 Turf Rider	Kenda	7.00	233
19211214	18x9.50 - 8	70 A4/81 A4*	4 PR	TL	K500 Super Turf	Kenda	7.00	236
12510116	18x9.50 - 8	81 A4	4 PR	TL	Turf Master	Carlisle	7.00	234
15710400	18x9.50 - 8	87 A6	6 PR	TL	LG 306	BKT	7.00	230
19211233	18x9.50 - 8	78 A4/89 A4*	6 PR	TL	K500 Super Turf	Kenda	7.00	234
10711480	18x9.50 - 8	91 B	6 PR	TL	C165 S	Cheng Shin	7.00	235
10691090	210/60 D 8	57 A6		TL	M40B	Bridgestone	6.5	210
19110151	20x8.00 - 8	67 A6/79 A6*	4 PR	TL	S-365	Deli	7.00	220
19211222	230/60 - 8	67 A4/78 A4*	4 PR	TL	K358 Turf Rider	Kenda	7.00	228
19211220	230/60 - 8	67 A4/78 A4*	4 PR	TL	K500 Super Turf	Kenda	7.00	222
10711485	20x8.00 - 8	79 B	4 PR	TL	C165 S	Cheng Shin	6.5	225
19211221	230/60 - 8	76 A4/87 A4*	6 PR	TL	K358 Turf Rider	Kenda	7.00	235
12500305	255/60 - 8	71 A4	2 PR	TL	Turf Saver	Carlisle	7.00	265
15710425	20x10.00 - 8	83 A6	4 PR	TL	LG 307	BKT	8.00/7.00	255
19110152	20x10.00 - 8	75 A6/87 A6*	4 PR	TL	S-366 K	Deli	7.00	234
19211224	20x10.00 - 8	74 A4/85 A4*	4 PR	TL	K358 Turf Rider	Kenda	7.00	252
19211225	20x10.00 - 8	75 A4/86 A4*	4 PR	TL	K500 Super Turf	Kenda	7.00	249
19211227	20x10.00 - 8	75 A4/86 A4*	4 PR	TL	K505	Kenda	7.00	244
12500344	250/60 - 8	87 A4	4 PR	TL	Turf Trac R/S	Carlisle	7.00	246
15710420	20x10.00 - 8	94 A3/90 A6	6 PR	TL	LG 306	BKT	8.00/7.00	254
19211223	20x10.00 - 8	82 A4/94 A4*	6 PR	TL	K358 Turf Rider	Kenda	7.0/8.0	254
19211226	20x10.00 - 8	82 A4/94 A4*	6 PR	TL	K500 Super Turf	Kenda	8.00	261
18692400	20x10.00 - 8	94 A6	6 PR	TT	T539	Trelleborg	8.50/8.00	244
12500374	22x11.00 - 8	78 A4	4 PR	TL	Turf CTR	Carlisle	9.00/8.50/10.50	274
12500343	265/70 - 8	92 A4	4 PR	TL	Turf Trac R/S	Carlisle	7.00	267
12500366	25x12.00 - 9	101 A4	4 PR	TL	Turf Trac R/S	Carlisle	9.00/7.00/7.50/8.00 8.50/9.50/10.00/10.50	292
19110178	16x6.00 - 10	22 A4/35 A4*	2 PR	TL	SG-806 Turf Trak	Starco	4.50	155
15710426	18x8.50 - 10	73 A3/69 A6	4 PR	TL	LG 306	BKT	7.00	210
15710455	205/50 - 10	63 A6	4 PR	TL	GF 305 Classic	BKT	7.00/6.00	215

* = höhere Tragfähigkeit für Einsatz auf gezogenen Fahrzeugen, niedrigere Tragfähigkeit für Einsatz auf angetriebenen Achsen

¹ = empfohlene Felge / weitere zulässige Felgenbreiten

Alles auf einen Blick:

 Außen ø in mm	 Tragfähigkeit in kg	 km/h	 Luftdruck in bar
450	475/425	15/30	2,30
450	325/462	20	2,30
452	325/462	20	2,40
452	325/462	20	2,40
470	470	16	2,38
455	400/560	20	1,50
447	580	20	3,00
451	315	20	0,82
461	335/475	30	1,70
477	335/462	20	1,70
462	335/462	20	1,70
460	462	20	1,60
470	545	30	2,50
476	425/580	20	2,50
482	615	50	2,50
457	230	30	1,60
496	307/437	30	1,50
478	307/425	20	1,50
498	307/425	20	1,50
512	437	50	1,50
482	400/545	20	2,30
498	345	20	0,68
495	487	30	1,50
518	387/545	30	1,50
499	375/515	20	1,50
496	387/530	20	1,50
494	387/530	20	1,50
500	545	20	1,50
508	670/600	15/30	2,20
508	475/670	20	2,30
504	475/670	20	2,40
508	670	30	2,40
569	425	20	0,70
574	630	20	1,50
653	825	20	1,40
397	85/121	20	0,50
460	365/325	15/30	1,50
470	272	30	2,20



BKT LG 306

BKT LG 307

BKT GF 305 Classic



Bridgestone M40B

Carlisle Multi Trac C/S

Carlisle Turf CTR

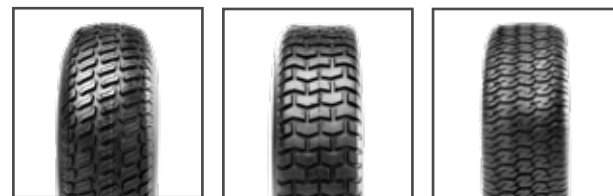

Carlisle Turf Master

Carlisle Turf Saver

Carlisle Turf Trac R/S

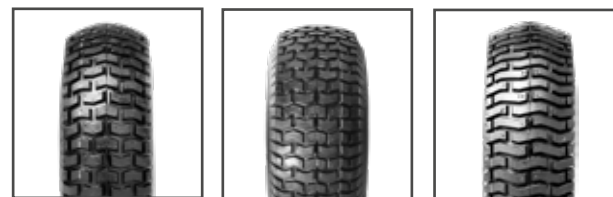

Cheng Shin C165 S

Deli S-365

Deli S-366 K



Kenda K358
Turf Rider

Kenda K389
Hole-N-One

Kenda K500
Super Turf

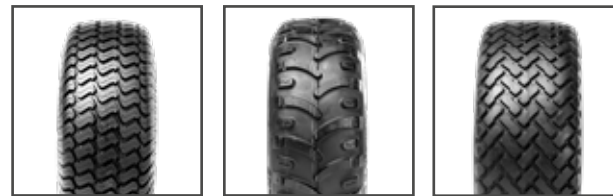

Kenda K505

Starco SG-806
Turf Trak

Trelleborg T539



Rasenreifen





Preise und Bestände finden Sie unter www.bohnenkamp.de/shop

Artikel-Nr.	Größe	Last-/ Speed-Index	PR	TL/ TT	Profil	Marke	Felge ¹	Breite in mm
19211266	18x8.50 - 10	61 A4/72 A4*	4 PR	TL	K500 Super Turf	Kenda	6.00	190
19211267	18x8.50 - 10	61 A4/72 A4*	4 PR	TL	K513	Kenda	6.00	192
19266071	205/50 - 10	80 B	6 PR	TL	K399 Pro Tour	Kenda	6.00	195
12500404	205/50 - 10	67 B	4 PR	TL	Tour Max	Carlisle	6.00	192
12500372	215/50 - 10	74 A4/70 A6	4 PR	TL	Multi Trac C/S	Carlisle	7.00	205
12500409	260/40 - 10	80 A4	4 PR	TL	Multi Trac C/S	Carlisle	8.50	258
12500386	18x11.00 - 10	84 A4	4 PR	TL	Fast Trax	Carlisle	8.5/9.0	246
19211269	20x8.00 - 10	65 A4/76 A4*	4 PR	TL	K358 Turf Rider	Kenda	6.00	203
12500383	20x8.00 - 10	77 A4	4 PR	TL	Turf Saver	Carlisle	6.00/6/7.00	201
12500382	20x8.00 - 10	77 A4	4 PR	TL	Turf Master	Carlisle	6.00/6/7.00	205
10691160	20x8.00 - 10	67 A6	4 PR	TL	PD	Bridgestone	5.00	180
18692440	20x8.00 - 10		4 PR	TL	T539GT	Trelleborg	6/7	204
15710427	20x8.00 - 10	85 A3/81 A6	6 PR	TL	LG 306	BKT	6.00	205
19211270	20x8.00 - 10	74 A6/85 A6*	6 PR	TL	K358 Turf Rider	Kenda	6.00	206
19211273	20x8.00 - 10	74 A6/85 A6*	6 PR	TL	K513	Kenda	6.00	218
19800109	20x8.00 - 10	67 A6	4 PR	TL	M40B	Bridgestone	6.00	193
18692442	20x8.00 - 10	89 A6	6 PR	TL	T539	Trelleborg	6.00	206
15710430	20x10.00 - 10	82 A6	4 PR	TL	LG 306	BKT	8.00/7.00	250
19211280	20x10.00 - 10	74 A4/85 A4*	4 PR	TL	K358 Turf Rider	Kenda	8.00	237
19211277	20x10.00 - 10	74 A4/85 A4*	4 PR	TL	K500 Super Turf	Kenda	8.00	246
19211274	20x10.00 - 10	74 A4/85 A4*	4 PR	TL	K513	Kenda	7.00	235
12500387	255/50 - 10	86 A4	4 PR	TL	Turf Master	Carlisle	6.00/7.00/8.00	224
12500602	245/50 - 10	86 A4	4 PR	TL	Turf Trac R/S	Carlisle	8.00	238
15710431	20x10.00 - 10	94 A3/90 A6	6 PR	TL	LG 306	BKT	8.00	250
19211279	20x10.00 - 10	86 A4/97 A4*	6 PR	TL	K358 Turf Rider	Kenda	8.00	256
19211276	20x10.00 - 10	86 A4/97 A4*	6 PR	TL	K500 Super Turf	Kenda	8.00/7.00	246
19211275	20x10.00 - 10	77 A4/88 A4*	6 PR	TL	K389 Hole-N-One	Kenda	8.50/8.00	253
12500389	245/50 - 10	93 A4	6 PR	TL	Multi Trac C/S	Carlisle	8.00/7.00	236
18692448	20x10.00 - 10	93 A6	6 PR	TL	T539	Trelleborg	7.00/8.50	242
15710450	20x12.00 - 10	87 A6	4 PR	TL	LG 307	BKT	8.5	285
19211281	20x12.00 - 10	78 A4/89 A4*	4 PR	TL	K516	Kenda	9.75/8.50	287
12500403	305/40 - 10	90 A4	4 PR	TL	Turf Trac R/S	Carlisle	7.00	257
19211282	20.5x8.00 - 10	65 A4/76 A4*	4 PR	TL	K513	Kenda	6.00	213
10691170	20.5x8.00 - 10	74 A6	4 PR	TL	PD1	Bridgestone	6.00	205
19211286	22x9.50 - 10	75 A4/86 A4*	4 PR	TL	K506	Kenda	7.00	235
12598013	22x9.50 - 10	79 A4	4 PR	TL	Turf Trac R/S	Carlisle	7.00	241
19211288	20x10.00 - 10	79 A4/90 A4*	4 PR	TL	K500 Super Turf	Kenda	7.00	254
12500407	22x11.00 - 10	94 A4	4 PR	TL	Turf Master	Carlisle	7.00	257
19210155	22x11.00 - 10	90 A4/102 A4*	6 PR	TL	K502 Terra Trac	Kenda	10	289

* = höhere Tragfähigkeit für Einsatz auf gezogenen Fahrzeugen, niedrigere Tragfähigkeit für Einsatz auf angetriebenen Achsen

¹ = **empfohlene Felge** / weitere zulässige Felgenbreiten

Alles auf einen Blick:

 Außen ø in mm	 Tragfähigkeit in kg	 km/h	 Luftdruck in bar
462	257/355	20	1,50
461	257/355	20	1,50
466	450	50	3,10
474	307	50	2,10
457	375/335	20/30	1,52
455	450	20	1,40
451	500	20	1,50
516	290/400	20	1,50
508	412	20	1,60
512	412	20	1,60
503	307	30	1,60
512	412	30	1,70
500	515/462	15/30	2,60
531	375/515	30	3,00
518	375/515	30	3,00
502	307	30	1,60
508	580	30	2,90
508	475	30	1,50
519	375/515	20	1,50
501	375/515	20	1,50
510	375/515	20	1,50
508	530	20	1,50
497	530	20	1,50
508	670/600	15/30	2,20
516	530/730	20	2,80
501	530/730	20	2,80
504	412/560	20	2,20
498	650	20	2,20
512	650	30	2,40
500	545	30	1,40
500	425/580	20	1,40
503	600	20	1,30
522	290/400	20	1,60
533	375	30	1,60
546	387/530	20	1,50
551	437	20	0,97
560	437/600	20	1,50
551	670	20	1,50
564	600/850	20	2,40



BKT LG 306



BKT LG 307



Bridgestone M40B



Bridgestone PD

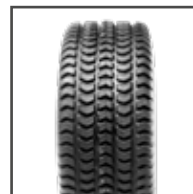

Bridgestone PD1



Carlisle Fast Trax



Carlisle Multi Trac C/S

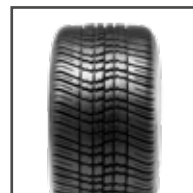

Carlisle Tour Max



Carlisle Turf Master

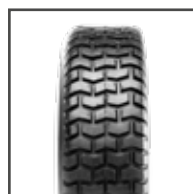

Carlisle Turf Saver



Carlisle Turf Trac R/S



Kenda K358
Turf Rider

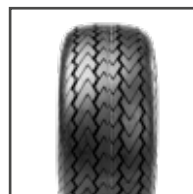

Kenda K389
Hole-N-One

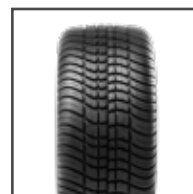

Kenda K399
Pro Tour



Kenda K500
Super Turf

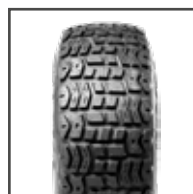

Kenda K502
Terra Trac



Kenda K506



Kenda K513



Kenda K516



Trelleborg T539 /
T539GT



Rasenreifen





Preise und Bestände finden Sie unter www.bohnenkamp.de/shop

Artikel-Nr.	Größe	Last-/ Speed-Index	PR	TL/ TT	Profil	Marke	Felge ¹	Breite in mm
12598014	240/75 - 10	93 A4/88 A8	4 PR	TL	Turf Trac R/S	Carlisle	7.75/7.5/8.0/8.5	249
19211291	24x12.00 - 10	77 A4/88 A4*	4 PR	TL	K506	Kenda	8.00	282
10691370	6 - 12	63 A6	4 PR	TT	FD	Bridgestone	5	164
10691180	22x8.50 - 12	75 A6	4 PR	TL	PD1	Bridgestone	7	212
12500564	230/50 - 12	72 A4	2 PR	TL	Turf Saver	Carlisle	7.00	225
19211310	22x9.50 - 12	76 A4/87 A4*	4 PR	TL	K500 Super Turf	Kenda	7.00	226
12500519	240/55 - 12	89 A4	4 PR	TL	Turf Master	Carlisle	7.00	234
19211311	23x8.50 - 12	72 A4/83 A4*	4 PR	TL	K358 Turf Rider	Kenda	7.00	213
19211315	23x8.50 - 12	72 A4/83 A4*	4 PR	TL	K500 Super Turf	Kenda	7.00	214
12500495	23x8.50 - 12	84 A4	4 PR	TL	Turf Master	Carlisle	7.00/6.0/6.5/7	213
15710480	23x8.50 - 12	89 A6	6 PR	TL	LG 306	BKT	7.00	210
19211312	23x8.50 - 12	81 A4/92 A4*	6 PR	TL	K358 Turf Rider	Kenda	7.00	216
19211314	23x8.50 - 12	81 A4/92 A4*	6 PR	TL	K500 Super Turf	Kenda	7.00	215
19211313	23x8.50 - 12	98 A4/110 A4*	10 PR	TL	K500 Super Turf	Kenda	7.00	219
18692510	23x8.50 - 12		10 PR	TT	T539	Trelleborg	7.00	212
15710483	23x8.50 - 12	102 A6	12 PR	TL	LG 306	BKT	7.00	210
19211316	23x9.50 - 12	80 A4/91 A4*	4 PR	TL	K500 Super Turf	Kenda	7.00	247
12500500	23x9.50 - 12	88 A4	4 PR	TL	Multi Trac C/S	Carlisle	7.00/8.50	229
12500517	23x10.50 - 12	76 A4	2 PR	TL	Turf Saver	Carlisle	8.50	263
19211317	23x10.50 - 12	78 A4/89 A4*	4 PR	TL	K358 Turf Rider	Kenda	8.50	250
19211320	23x10.50 - 12	78 A4/89 A4*	4 PR	TL	K500 Super Turf	Kenda	8.50	264
19210180	23x10.50 - 12	78 A4/89 A4*	4 PR	TL	K502 Terra Trac	Kenda	8.50	260
12500516	23x10.50 - 12	92 A4	4 PR	TL	Turf Master	Carlisle	8.50	254
12500522	260/50 - 12	90 A4	4 PR	TL	Turf Trac R/S	Carlisle	8.50	259
19800135	23x10.50 - 12	85 A6	4 PR	TL	M40B	Bridgestone	8.5	264
12520130	23x10.50 - 12	90 A4	4 PR	TL	Industrial Trax	Carlisle	8.50/7.00/7	264
18692540	23x10.50 - 12	90 A6	4 PR	TL	T539	Trelleborg	7.00/8.5	269
15710490	23x10.50 - 12	96 A6	6 PR	TL	LG 306	BKT	8.5/7.00	260
19211319	23x10.50 - 12	87 A4/99 A4*	6 PR	TL	K500 Super Turf	Kenda	8.50	265
18692552	23x10.50 - 12	100 A6	6 PR	TL	T539	Trelleborg	7.00/8.50	247
15710491	23x10.50 - 12	102 A6	8 PR	TL	LG 306	BKT	8.5/7.00	260
19211321	23x10.50 - 12	94 A4/106 A4*	8 PR	TL	K500 Super Turf	Kenda	8.50	265
15710493	23x10.50 - 12	111 A6	12 PR	TL	LG 306	BKT	8.5/7.00	260
18692545	23x12.50 - 12	105 A6	6 PR	TL	T539	Trelleborg	10/10.50	317
19211349	215/70 - 12	76 A6/87 A6*	4 PR	TL	K505	Kenda	7.00	218
10711620	24x8.50 - 12	83 A8	4 PR	TL	C165 S	Maxxis	7.00	220
10691200	24x8.50 - 12	78 A6	4 PR	TL	PD1	Bridgestone	7.00	219
10691215	24x8.50 - 12	78 A6	4 PR	TL	M40B	Bridgestone	7.00	222
19211324	24x9.50 - 12	80 A4/91 A4*	4 PR	TL	K500 Super Turf	Kenda	7.00	247

* = höhere Tragfähigkeit für Einsatz auf gezogenen Fahrzeugen, niedrigere Tragfähigkeit für Einsatz auf angetriebenen Achsen

¹ = empfohlene Felge / weitere zulässige Felgenbreiten

Alles auf einen Blick:

 Außen ø in mm	 Tragfähigkeit in kg	 km/h	 Luftdruck in bar
617	650/560	20/40	1,52
610	412/560	20	1,00
605	272	30	2,00
552	387	30	1,60
542	355	20	1,00
551	400/545	20	1,50
559	580	20	1,60
580	355/487	20	1,50
574	355/487	20	1,50
581	500	20	1,50
575	580	30	2,30
590	462/630	20	2,40
576	462/630	20	2,30
570	750/1060	20	5,60
568	1115	25	3,70
575	850	30	4,50
599	450/615	20	1,70
589	560	20	1,40
578	400	20	0,68
580	425/580	20	1,40
580	425/580	20	1,40
583	425/580	20	1,40
592	630	20	1,30
574	600	20	1,30
589	515	30	1,60
572	600	20	1,30
580	600	30	1,40
585	710	30	2,20
580	545/775	20	2,20
571	800	30	2,20
585	850	30	3,00
580	670/950	20	3,00
585	1090	30	4,50
584	925	30	2,90
602	400/545	30	1,60
608	487	40	2,50
606	425	30	1,60
620	425	30	1,60
599	450/615	20	1,70



BKT LG 306



Bridgestone FD

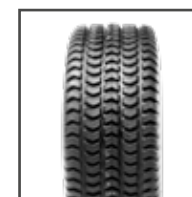

Bridgestone PD1

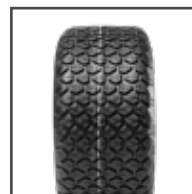

Bridgestone M40B



Carlisle Industrial Trax



Carlisle Multi Trac C/S



Carlisle Turf Master



Carlisle Turf Saver



Carlisle Turf Trac R/S

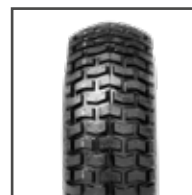

Cheng Shin C165 S

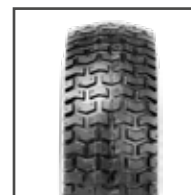

Kenda K358
Turf Rider



Kenda K500
Super Turf

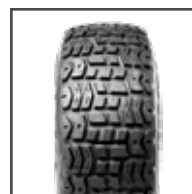

Kenda K502
Terra Trac



Kenda K505



Kenda K506



Trelleborg T539



Rasenreifen





Preise und Bestände finden Sie unter www.bohnenkamp.de/shop

Artikel-Nr.	Größe	Last-/ Speed-Index	PR	TL/ TT	Profil	Marke	Felge ¹	Breite in mm
12500523	240/60 - 12	94 A4	4 PR	TL	Turf Master	Carlisle	7.00	240
12500537	240/65 - 12	93 A4	4 PR	TL	Multi Trac C/S	Carlisle	7.00/7/8.50	241
15710492	24x12.00 - 12	95 A6	4 PR	TL	LG 306	BKT	9.5/8.0/8.5/9.0	298
19211329	24x12.00 - 12	87 A4/98 A4*	4 PR	TL	K500 Super Turf	Kenda	8.50	290
12500518	24x12.00 - 12	99 A4	4 PR	TL	Turf Master	Carlisle	8.50	290
19211328	24x12.00 - 12	97 A4/108 A4*	6 PR	TL	K505	Kenda	10.50	310
12500594	290/50 - 12	109 A4	6 PR	TL	Turf Trac R/S	Carlisle	8.50	285
19211327	24x12.00 - 12	104 A4/117 A4*	8 PR	TL	K500 Super Turf	Kenda	8.50/9.0/9.5/10.0/10.5	292
19211361	24x13.00 - 12	87 A4/98 A4*	4 PR	TL	K507	Kenda	10.50	333
12500595	330/40 - 12	100 A4	4 PR	TL	Ultra Trac	Carlisle	10.50	328
15710496	24x13.00 - 12	107 A6	6 PR	TL	LG 408	BKT	10.50	320
19211330	24x13.00 - 12	96 A4/108 A4*	6 PR	TL	K507	Kenda	10.50	333
12598018	24x13.00 - 12	109 A4	6 PR	TL	Ultra Trac	Carlisle	10.50	327
19210185	25x9.00 - 12	79 A4/90 A4*	4 PR	TL	K502 Terra Trac	Kenda	7.00	223
12598026	230/70 - 12	95 A4	4 PR	TL	Multi Trac C/S	Carlisle	8.00/6.0/6.5/7.0/7.5	242
12598019	25x11.00 - 12	101 A4	4 PR	TL	Multi Trac C/S	Carlisle	8.00/8.5/9.0	275
19211335	26x12.00 - 12	87 A4/99 A4*	4 PR	TL	K500 Super Turf	Kenda	10.50	325
19211336	26x12.00 - 12	87 A4/99 A4*	4 PR	TL	K505	Kenda	10.50	307
12500580	285/60 - 12	100 A4/96 A6	4 PR	TL	Multi Trac C/S	Carlisle	8.50/8.0/9.5/10.5	287
12500575	26x12.00 B 12	109 A4	6 PR	TL	Multi Trac C/S	Carlisle	8.50/8.0/9.5/10.5	292
15710500	26x12.00 - 12	116 A3/112 A6	8 PR	TL	LG 306	BKT	10.50/10/8	310
19211333	26x12.00 - 12	106 A4/119 A4*	8 PR	TL	K500 Super Turf	Kenda	10.50/8.50/9.50	321
18692610	26x12.00 - 12	116 A6	8 PR	TL	T539	Trelleborg	10.5/9.5	320
19211334	26x12.00 - 12	110 A4/122 A4*	10 PR	TL	K500 Super Turf	Kenda	10.50	325
12500582	305/55 - 12	122 A4	10 PR	TL	Turf Trac R/S	Carlisle	10.50/8.0/8.5/9.5	315
15710501	26x12.00 - 12	124 A3/121 A6	12 PR	TL	LG 306	BKT	10.50/10/8	310
15710502	26x12.00 - 12	123 A6	14 PR	TL	LG 306	BKT	10.50/10.50/8.50	310
15710525	26.5x14.00 - 12	113 A6	6 PR	TL	LG 408	BKT	12.00	380
19211338	26.5x14.00 - 12	94 A4/106 A4*	4 PR	TL	K507	Kenda	10.50	376
12500560	26.5x14.00 - 12	107 A4	4 PR	TL	Ultra Trac	Carlisle	10.50/11.0/12.0	366
19211366	26.5x14.00 - 12	102 A4/114 A4	6 PR	TL	K507	Kenda	10.50	379
10691405	6 - 14	67 A6	4 PR	TT	FD	Bridgestone	5	163
15710532	24x8.50 - 14	84 A6	4 PR	TL	LG 306	BKT	7	210
19211354	215/60 - 14	76 A6/87 A6*	4 PR	TL	K505	Kenda	7.00	216
12500640	24x8.50 - 14	88 A4	4 PR	TL	Multi Trac C/S	Carlisle	7.00/6.0/6.5/7.0	212
10691217	24x8.50 - 14	78 A6	4 PR	TL	PD1	Bridgestone	7	216
10691220	25x8.50 - 14	82 A6	4 PR	TL	PD1	Bridgestone	7	219
19211355	215/65 - 14	87 A6/98 A6*		TL	K505	Kenda	7.00	221
15710531	25x8.50 - 14	98 A3/94 A6	6 PR	TL	LG 306	BKT	7.00	220

* = höhere Tragfähigkeit für Einsatz auf gezogenen Fahrzeugen, niedrigere Tragfähigkeit für Einsatz auf angetriebenen Achsen

¹ = empfohlene Felge / weitere zulässige Felgenbreiten

Alles auf einen Blick:

 Außen ø in mm	 Tragfähigkeit in kg	 km/h	 Luftdruck in bar
599	670	20	1,60
610	650	20	1,50
610	690	30	1,40
595	545/750	20	1,40
598	775	20	1,30
609	730/1000	20	2,20
587	1030	20	2,20
598	900/1285	20	3,50
610	545/750	20	1,20
579	800	20	1,20
605	975	30	2,20
610	710/1000	20	1,90
593	1030	20	1,90
627	437/600	20	1,40
633	690	20	1,60
640	825	20	1,60
655	545/775	20	1,40
645	545/775	20	1,50
648	800/710	20/30	1,38
650	1030	20	2,00
640	1250/1120	15/30	3,00
669	950/1360	20	3,50
652	1150	30	2,70
659	1060/1500	20	4,20
643	1500	20	3,51
640	1600/1450	15/30	4,50
640	1550	30	5,20
665	1150	30	2,00
670	670/950	20	1,20
673	975	20	1,20
668	850/1180	20	1,80
654	307	30	2,00
610	500	30	1,60
607	400/545	30	2,00
604	560	20	1,50
604	425	30	1,60
646	475	30	1,60
635	545/750	30	3,00
638	750/670	15/30	2,20



BKT LG 306

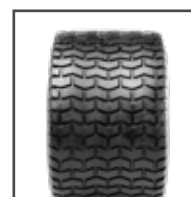

BKT LG 408



Bridgestone FD



Bridgestone PD1



Carlisle Multi Trac C/S



Carlisle Turf Master



Carlisle Turf Trac R/S



Carlisle Ultra Trac



Kenda K500
Super Turf

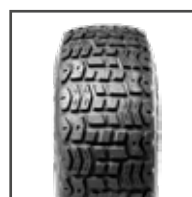

Kenda K502
Terra Trac



Kenda K505

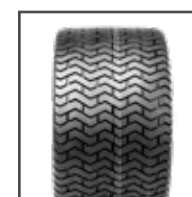

Kenda K507



Trelleborg T539



Rasenreifen





Preise und Bestände finden Sie unter www.bohnenkamp.de/shop

Artikel-Nr.	Größe	Last-/Speed-Index	PR	TL/TT	Profil	Marke	Felge ¹	Breite in mm
12500651	215/65 - 14	98 A4	6 PR	TL	Multi Trac C/S	Carlisle	7.00 /6.0/6.5	218
19800161	250/60 D 14	79 A6		TL	M40B	Bridgestone	7	251
12011270	25x10.50LL - 15	114 A2/100 A6	6 PR	TL	Turf Special	Galaxy	8	262
15710540	27x8.50 - 15	92 A6/88 B	4 PR	TL	LG 306	BKT	7.00	216
19211358	215/70 - 15	85 A6/96 A6*		TL	K505	Kenda	7.00	213
10691300	27x8.50 - 15	85 A6	4 PR	TL	PD1	Bridgestone	7	220
12500670	215/70 - 15	96 B	6 PR	TL	Multi Trac C/S	Carlisle	7.00	218
12098008	27x8.50 - 15	96 B	6 PR	TL	Mighty Mow	Galaxy	7	213
15710545	27x10.50 - 15	90 A3/87 A6	4 PR	TL	LG 306	BKT	8.00	272
12500675	265/55 - 15	90 B	4 PR	TL	Multi Trac C/S	Carlisle	8.50 /8	273
12598089	280/55 - 15	102 B	8 PR	TL	Multi Trac C/S	Carlisle	8.50 /8	285
19211357	212/80 - 15	68 A6/79 A6*		TL	K505	Kenda	7.00	217
10691321	215/80 - 15	80 A6	4 PR	TT	PD1	Bridgestone	7	215
19211365	295/60 - 15	88 A6/100 A6*		TL	K505	Kenda	10	300
10711660	29x12.00 - 15	101 A8	4 PR	TL	C165 S	Maxxis	10.00	298
10691330	29x12.00 - 15	102 A6	4 PR	TL	PD1	Bridgestone	10	307
12500689	320/55 - 15	112 B	10 PR	TL	Multi Trac C/S	Carlisle	10.00 /10	318
12500700	360/50 - 15	99 B	6 PR	TL	Ultra Trac	Carlisle	12.00 /11/12/13	366
12500704	345/60 - 15	107 A4/98 B	4 PR	TL	Multi Trac C/S	Carlisle	10.00 /10	343
15710549	31x15.50 - 15	95 A6	4 PR	TL	LG 306	BKT	13	391
19111143	400/50 - 15	109 A8/121 A8*	10 PR	TL	SE-374	Deli	13.00	385
12500708	360/55 - 15	116 B	8 PR	TL	Turf Pro R-3	Carlisle	13.00	361
10691780	315/75 D 15	95 A6	4 PR	TL	M40B	Bridgestone	10	316
10691455	8 - 16	82 A6	4 PR	TT	FD	Bridgestone	6.00	208
10691800	315/80 D 16	104 A6	6 PR	TL	M40B	Bridgestone	10	316
15211668	12.4 - 16	121 A8	10 PR	TT	316	Alliance	11 /10	315
15710575	13.6 - 16	106 A3/102 A6	4 PR	TL	LG 306	BKT	12 /11	388
12500723	400/70 - 16	96 A8	4 PR	TL	Turf Pro R-3	Carlisle	12.00 /10/12	398
10691510	13.6 - 16	100 A6	4 PR	TT	PD1	Bridgestone	12	357
12011440	33x16LL - 16.1	135 A6/147 A2	10 PR	TL	Turf Special	Galaxy	14.00	427
12011500	41x18LL - 16.1	139 A3/135 A6	6 PR	TL	Turf Special	Galaxy	16	487
12011520	22.5LL - 16.1	148 A3/145 A6	6 PR	TL	Turf Special	Galaxy	18 /16	574
12011530	10 - 16.5	129 A2	8 PR	TL	Mighty Mow	Galaxy	8.25	264
12011542	12 - 16.5	144 A2	12 PR	TL	Mighty Mow	Galaxy	9.75	318
19211360	33x12.50 - 16.5	97 A4/109 A4*	4 PR	TL	K500 Super Turf	Kenda	9.75	318
15710577	33x15.50 - 16.5	125 A3/121 A6	10 PR	TL	LG 306	BKT	12.00 /11.00/13.00	396

* = höhere Tragfähigkeit für Einsatz auf gezogenen Fahrzeugen, niedrigere Tragfähigkeit für Einsatz auf angetriebenen Achsen

¹ = empfohlene Felge / weitere zulässige Felgenbreiten

Alles auf einen Blick:

 Außen ø in mm	 Tragfähigkeit in kg	 km/h	 Luftdruck in bar
632	750	20	2,20
660	437	30	1,60
643	1180/800	10/30	0,70
680	630/560	30/50	2,10
675	515/710	30	3,20
684	515	30	1,60
676	710	50	3,10
681	710	50	3,10
705	600/545	15/30	2,10
675	600	50	2,00
693	850	50	4,10
721	315/437	30	1,60
721	450	30	1,60
757	560/800	30	1,40
742	825	40	2,50
750	850	30	1,60
737	1120	50	4,15
737	775	50	2,10
800	975/750	20/50	1,40
792	690	30	1,40
776	1030/1450	40	3,00
770	1250	50	3,10
853	690	30	1,20
790	475	30	1,60
910	900	30	1,60
931	1450	40	3,50
975	950/850	15/30	1,00
978	710	40	1,00
997	800	30	1,00
833	3075/2180	10/30	2,60
1040	2430/2240	15/30	1,40
1133	3150/2900	15/30	1,20
780	1850	10	3,10
835	2800	10	5,50
838	730/1030	20	2,10
840	1650/1450	15/30	2,10



Alliance 316



BKT LG 306

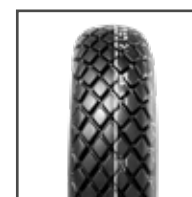

Bridgestone FD



Bridgestone M40B

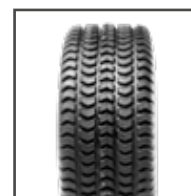

Bridgestone PD1



Carlisle Multi Trac C/S



Carlisle Turf Pro R-3

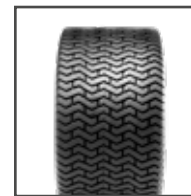

Carlisle Ultra Trac

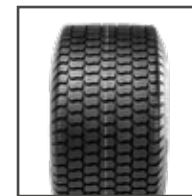

Deli SE-374



Galaxy Mighty Mow

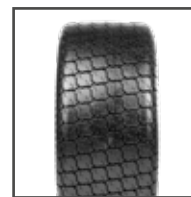

Galaxy Turf Special



Kenda K500
Super Turf



Kenda K505

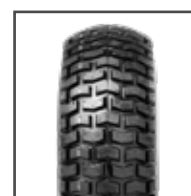

Maxxis C165 S



Rasenreifen





Preise und Bestände finden Sie unter www.bohnenkamp.de/shop

Artikel-Nr.	Größe	Last-/ Speed-Index	PR	TL/ TT	Profil	Marke	Felge ¹	Breite in mm
15710620	38x14.00 - 20	114 A6/110 B	4 PR	TL	LG 306	BKT	11	375
10691830	355/80 D 20	111 A6	4 PR	TT	PD1	Bridgestone	11	345
12500801	41x14.00 B 20	120 B	4 PR	TL	Multi Trac R-3	Carlisle	11	375
12098007	41x14.00 - 20	120 B	4 PR	TL	Mighty Mow	Galaxy	11	351
15710630	44x18.00 - 20	122 A3/119 A6	4 PR	TL	LG 306	BKT	14	475
19800248	475/65 D 20	122 A6	4 PR	TT	PD1	Bridgestone	15	465
12500820	9.5 - 24	102 A8	6 PR	TL	Turf Pro R-3	Carlisle	8.00/7/8	241
12500840	310/75 - 24	106 A8	6 PR	TL	Turf Pro R-3	Carlisle	10.00/9/10	315
12025400	17.5L - 24	139 A8	8 PR	TL	Mighty Mow	Galaxy	15	445

¹ = **empfohlene Felge** / weitere zulässige Felgenbreiten



Alles auf einen Blick:

 Außen ø in mm	 Tragfähigkeit in kg	 km/h	 Luftdruck in bar
980	1180/1060	30/50	1,70
1076	1090	30	1,20
1067	1400	50	1,80
1064	1400	50	1,70
1180	1500/1360	15/30	1,40
1126	1500	30	1,20
1024	850	40	2,00
1077	950	40	1,71
1241	2430	40	1,80



BKT LG 306

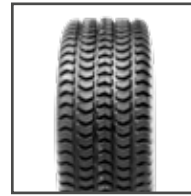

Bridgestone PD1



Carlisle Multi Trac R-3



Carlisle Turf Pro R-3

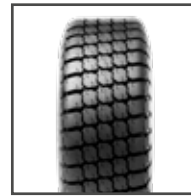

Galaxy Mighty Mow





Rasenreifen





Preise und Bestände finden Sie unter www.bohnenkamp.de/shop

Artikel-Nr.	Größe	Last-/Speed-Index	PR	TL/TT	Profil	Marke	Felge ¹	Breite in mm	Außen ø in mm
15226983	320/85 R 28	124 A8/124 B		TL	579	Alliance	10	328	1252
15722336	12.4 - 28	123 A6	8 PR	TL	TR 387	BKT	11/9/10	325	1200
15222450	13.6 - 28	121 A8	6 PR	TL	329	Alliance	12/11	345	1311
15226987	340/85 R 28	127 A8/127 B		TL	579	Alliance	12	343	1289
15226990	360/70 R 28	125 A8/125 B		TL	579	Alliance	11	357	1251
15722437	16.9 - 28	135 A6	8 PR	TL	TR 387	BKT	15/14	440	1400
15226993	480/70 R 28	140 A8/140 B		TL	579	Alliance	15	479	1421
15722465	16.9 - 30	137 A6	8 PR	TL	TR 387	BKT	15/14	440	1450
15722475	18.4 - 30	139 A6	8 PR	TL	TR 387	BKT	16	475	1530
15226996	480/70 R 30	141 A8/141 B		TL	579	Alliance	15	479	1478
15226999	480/70 R 34	143 A8/143 B		TL	579	Alliance	15/14/16	479	1580

¹ = **empfohlene Felge** / weitere zulässige Felgenbreiten



Alles auf einen Blick:

				
statischer Halbmesser in mm	Abrollumfang in mm	Tragfähigkeit in kg	km/h	Luftdruck in bar
562	3741	1600	40/50	1,60
550	3576	1550	30	2,30
610	3942	1450	40	1,60
607	3835	1750	40/50	1,60
575	3768	1650	40/50	1,60
630	4074	2180	30	1,70
632	4210	2500	40/50	1,60
655	4220	2300	30	1,70
680	4395	2430	30	1,40
669	4420	2575	40/50	1,60
723	4715	2725	40/50	1,60



Alliance 329



Alliance 579



BKT TR 387



316

Traktorfelgen

318

Felgen Transportgeräte u. Karren

322

Implementfelgen

331

Flotationfelgen

336

**Anschlüsse für
Reifendruckregelanlage**

340

Forstfelgen

340

Industriefelgen

341

EM-Felgen

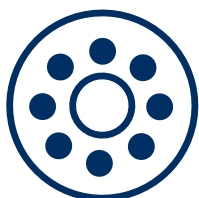

FELGEN

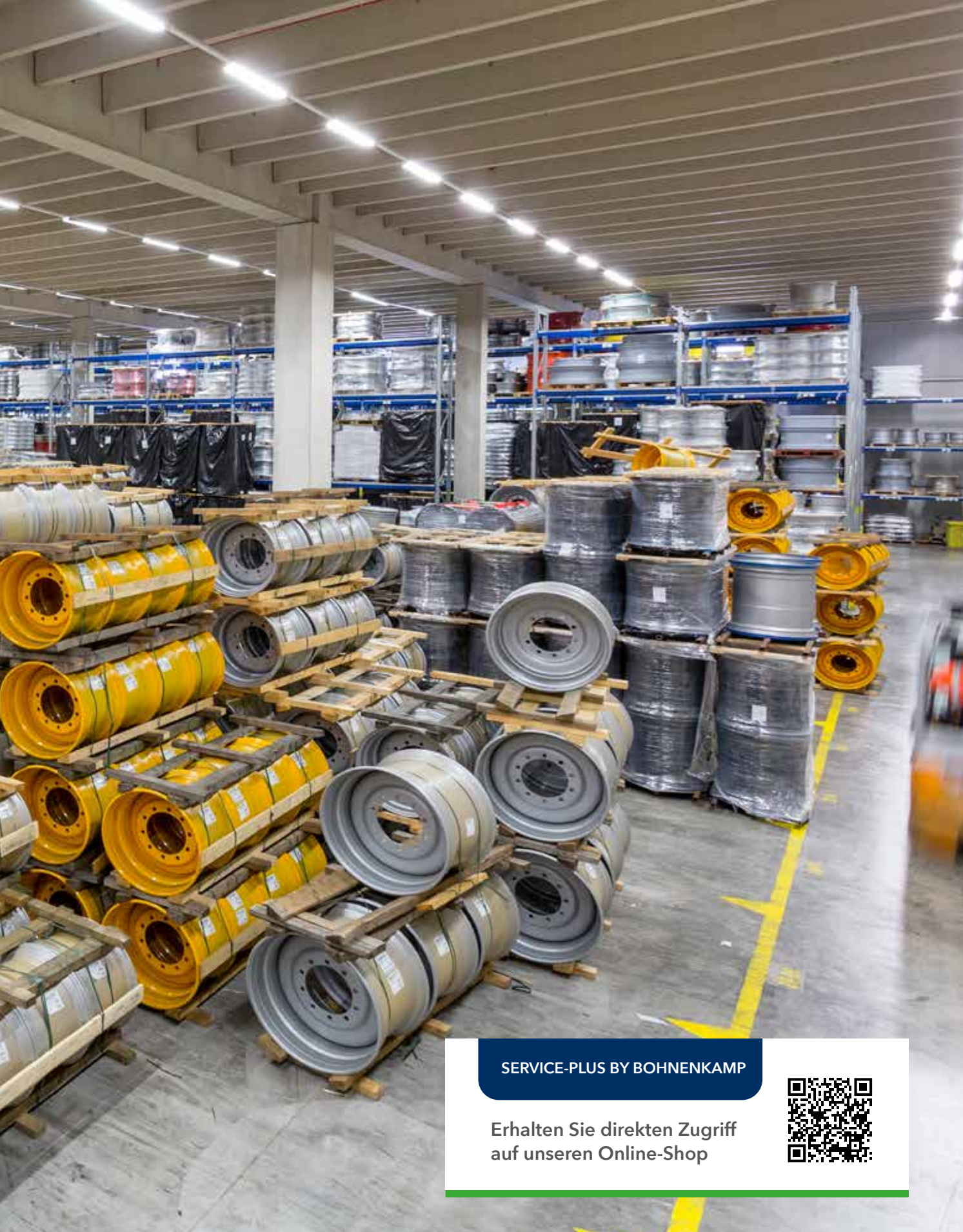

SERVICE-PLUS BY BOHNENKAMP

Erhalten Sie direkten Zugriff
auf unseren Online-Shop





Traktorfelgen

Preise und Bestände finden Sie unter www.bohnenkamp.de/shop



Artikel-Nr.	Größe	Artikel-Nr.	Größe	Artikel-Nr.	Größe
69999080	9 x 20	69999340	15 x 30	69999525	23 x 38
69999082	10 x 20	69999345	16 x 30	69999532	25 x 38
69999085	11 x 20	69999347	18 x 30	69999533	27 x 38
69999090	13 x 20	69999350	20 x 30	69999535	28 x 38
69999095	14 x 20	69999355	23 x 30	69999537	30 x 38
69999100	11.75 x 22.5	69999357	25 x 30	69999540	8 x 40
69999105	13.00 x 22.5	69999360	20.00 x 30.5	69999550	8 x 42
69999110	14.00 x 22.5	69999365	24.00 x 30.5	69999570	10 x 42
69999115	16.00 x 22.5	69999370	28.00 x 30.5	69999590	16 x 42
69999120	20.00 x 22.5	69999375	7 x 32	69999600	18 x 42
69999125	24.00 x 22.5	69999380	8 x 32	69999605	20 x 42
69999150	7 x 24	69999385	10 x 32	69999607	23 x 42
69999155	8 x 24	69999390	20 x 32	69999610	24 x 42
69999170	10 x 24	69999395	21 x 32	69999615	25 x 42
69999175	12 x 24	69999397	23 x 32	69999617	27 x 42
69999180	13 x 24	69999398	25 x 32	69999623	30 x 42
69999185	15 x 24	69999400	27 x 32	69999625	7 x 44
69999190	16 x 24	69999402	30 x 32	69999630	8 x 44
69999195	18 x 24	69999403	36 x 32	69999640	10 x 44
69999210	14 x 26	69999405	10 x 34	69999645	25 x 44
69999213	15 x 26	69999408	13 x 34	69999650	10 x 46
69999215	16 x 26	69999410	14 x 34	69999652	12 x 46
69999220	18 x 26	69999420	15 x 34	69999653	13 x 46
69999225	20 x 26	69999425	16 x 34	69999655	16 x 46
69999230	25 x 26	69999430	18 x 34	69999657	18 x 46
69999235	13.00 x 26.5	69999435	20 x 34	69999658	20 x 46
69999240	16.00 x 26.5	69999445	23 x 34	69999656	25 x 46
69999245	20.00 x 26.5	69999450	24 x 34	69999659	30 x 46
69999250	24.00 x 26.5	69999453	25 x 34	69999660	8 x 48
69999255	28.00 x 26.5	69999455	28 x 34	69999670	10 x 48
69999265	7 x 28	69999465	7 x 36	69999680	12 x 48
69999270	8 x 28	69999470	8 x 36	69999690	10 x 50
69999280	10 x 28	69999475	10 x 36	69999692	12 x 50
69999290	12 x 28	69999480	11 x 36	69999693	13 x 50
69999300	13 x 28	69999483	12 x 36	69999694	15 x 50
69999305	14 x 28	69999485	10 x 38	69999695	16 x 50
69999310	15 x 28	69999495	12 x 38	69999700	10 x 52
69999315	16 x 28	69999500	14 x 38	69999705	8 x 54
69999320	18 x 28	69999505	15 x 38	69999710	10 x 54
69999325	20 x 28	69999510	16 x 38	69999720	12 x 54
69999327	25 x 28	69999515	18 x 38	69999725	13 x 54
69999330	12 x 30	69999520	20 x 38		
69999335	14 x 30				

Sonderanfertigungen

Kompetent - Schnell - Zuverlässig

Je nach Einsatzzweck und Anspruch finden wir die optimale Lösung.



Sonderanfertigungen

Manchmal reicht der Standard nicht mehr aus. In diesen Fällen bieten wir eine Reihe an Sonderlösungen an, mit denen wir dann das Rad an Ihren individuellen Bedarf anpassen können, sei es durch zusätzliche Materialverstärkungen für eine größere Haltbarkeit oder durch Maßnahmen, die den Anwendungskomfort erhöhen, bzw. das Einsatzspektrum erweitern.

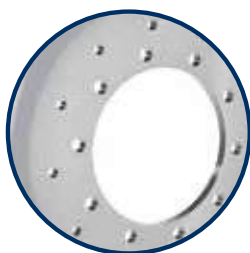

**Zusatz-
lochkreise**

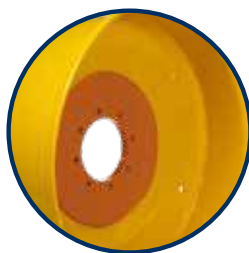

**Lochkreis-
verstärkungen**

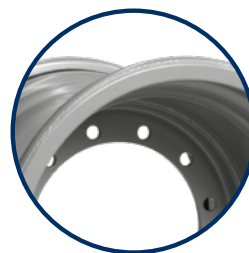

**Felgenhorn-
verstärkungen**



**Extra-
Ventilschutz**

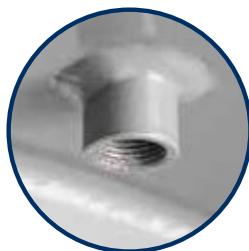

**Vorbereitung
Reifendruck-
regelanlage**

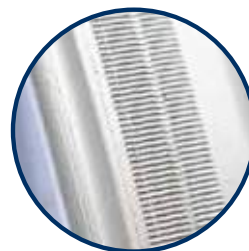

Knurling



Felgen Transportgeräte und Karren

Preise und Bestände finden Sie unter www.bohnenkamp.de/shop

Felgen mit Wellenanschluss

Artikel-Nr.	Felgengröße	Lagertyp	Wellendurchmesser [mm]	Nabenlänge [mm]	Einbaulänge [mm]	Tragfähigkeit [kg]	Geschwindigkeit [km/h]	Gewicht [kg]	Material	Zusatzinfo	Abbildung
39600007	2.10 - 4	Kugellager	20	50	50	400	16	1,00	Stahl		K1
39600018	2.10 x 4	Rollenlager	20	60	60	200	10	0,78	Stahl	rot RAL 3000	K5
30495020	2.10 x 4	Rollenlager	20	75	75	200	10	0,50	Stahl		K2
39600062	2.10 - 4	Kugellager	25	54	60	250	20	0,70	Stahl		K4
30495060	2.10 x 4	Rollenlager	25	75	75	200	10	0,50	Stahl		K2
39600320	2.10 - 4	Kugellager	25	75	75	400	16	0,70	Stahl		K1
39600019	2.10 - 4	Kugellager	25	75	90	400	16	0,70	Stahl		K4
39600013	2.10 - 4	Kugellager	25	75	75	225	16	0,70	Stahl	rot RAL 3002	K3
39600080	2.10 A x 4	ohne Lager	35	71	71	280	20	0,36	Stahl	rot RAL 3002	K5
39920027	2.50 C - 4 RFT	Kugellager	25	75	75	400	16	0,50	Stahl		K1
39600386	6.00 - 4	Kugellager	25	185	179	420	16	1,00	Stahl		K12
39600026	3.00 A x 5	Kugellager	20	100	100	170	16	1,20	Stahl		K6
39600029	2.50 A x 6	Kugellager	25	90	90	325	16	1,20	Stahl		K7
39600031	2.50 A x 6	ohne Lager	35	71	71	325	16	0,10	Kunststoff	rot RAL 3002	K8
39600299	4.50 A x 6 H2	Kugellager	25	74	64	257	30	2,00	Stahl		K7
30895080	4.50 A x 6	Kugellager	25	90	90	360	25	1,90	Stahl		K10
39600311	4.50 A x 6 H2	Kugellager	25	90	90	405	16	2,20	Stahl		K10
39600375	4.50 A x 6	Kugellager	25	95	71	405	16	2,00	Stahl	grau RAL 7032	K11
39600337	4.50 A x 6 H	Kugellager	25	98	90	335	30	2,20	Stahl		K9

Alles auf einen Blick:





Felgen Transportgeräte und Karren

Preise und Bestände finden Sie unter www.bohnenkamp.de/shop

Felgen mit Wellenanschluss

Artikel-Nr.	Felgenreöße	Lagertyp	Wellendurchmesser [mm]	Nabenlänge [mm]	Einbaulänge [mm]	Tragfähigkeit [kg]	Geschwindigkeit [km/h]	Gewicht [kg]	Material	Zusatzinfo	Abbildung
30695141	2.50 A x 8	Kugellager	25	75	75	250	6	0,85	Stahl		K14
30695120	2.50 A x 8	Rollenlager	25	75	75	250	20	1,05	Stahl	rot RAL 3000	K13
39600047	2.50 A x 8	Kugellager	25	88	88	400	10	1,00	Stahl		K14
30695142	2.50 A x 8	Kugellager	25	90	90	400	10	1,25	Stahl	rot RAL 3000	K26
39600060	2.50 A x 8	Kugellager	25	100	100	305	16	2,00	Stahl		K14
30695143	2.50 A x 8	Kugellager	30	75	75	500	20	1,90	Stahl		K14
39600112	2.50 A x 8	ohne Lager	35	71	71	340	20	0,90	Stahl	rot RAL 3002	K15
39600367	2.50 A x 8 H2	ohne Lager	35	71	71	350	16	0,50	Kunststoff	schwarz RAL 9005	K17
39600034	2.50 A x 8	ohne Lager	35	71	71	350	16	0,76	Kunststoff	rot RAL 3000	K16
39600114	2.50 A x 8	ohne Lager	46,9	82	82	350	6	1,40	Stahl		K18
39920102	3.00 D - 8	Kugellager	25	100	100	820	16	3,75	Stahl		K19
30895200	3.00 D x 8	Kugellager	30	100	100	320	40	2,80	Stahl		K14
39600351	3.00 D - 8	Kugellager	35	68	68	820	16	3,75	Stahl		K19
39600052	5.50 A x 8 H2	Kugellager	25	73	64	700	16	3,25	Stahl		K20
30895220	5.50 A x 8	Kugellager	25	90	90	360	25	2,80	Stahl		K21
39600089	5.50 A x 8 H2	Kugellager	25	100	89	500	20	3,25	Stahl		K22
39600104	5.50 A x 8 H2	Kugellager	25	157	160	365	16	2,64	Stahl	rot RAL 3002	K23
30895260	7.00 I x 8	Kugellager	25	90	90	425	40	3,70	Stahl		K24
39920168	7.00 A x 8 H2	Kugellager	25	110	102	535	16	3,50	Stahl		K25
39600329	7.00 A x 8 H2	Kugellager	30	127	107	535	16	4,65	Stahl		K25



Alles auf einen Blick:

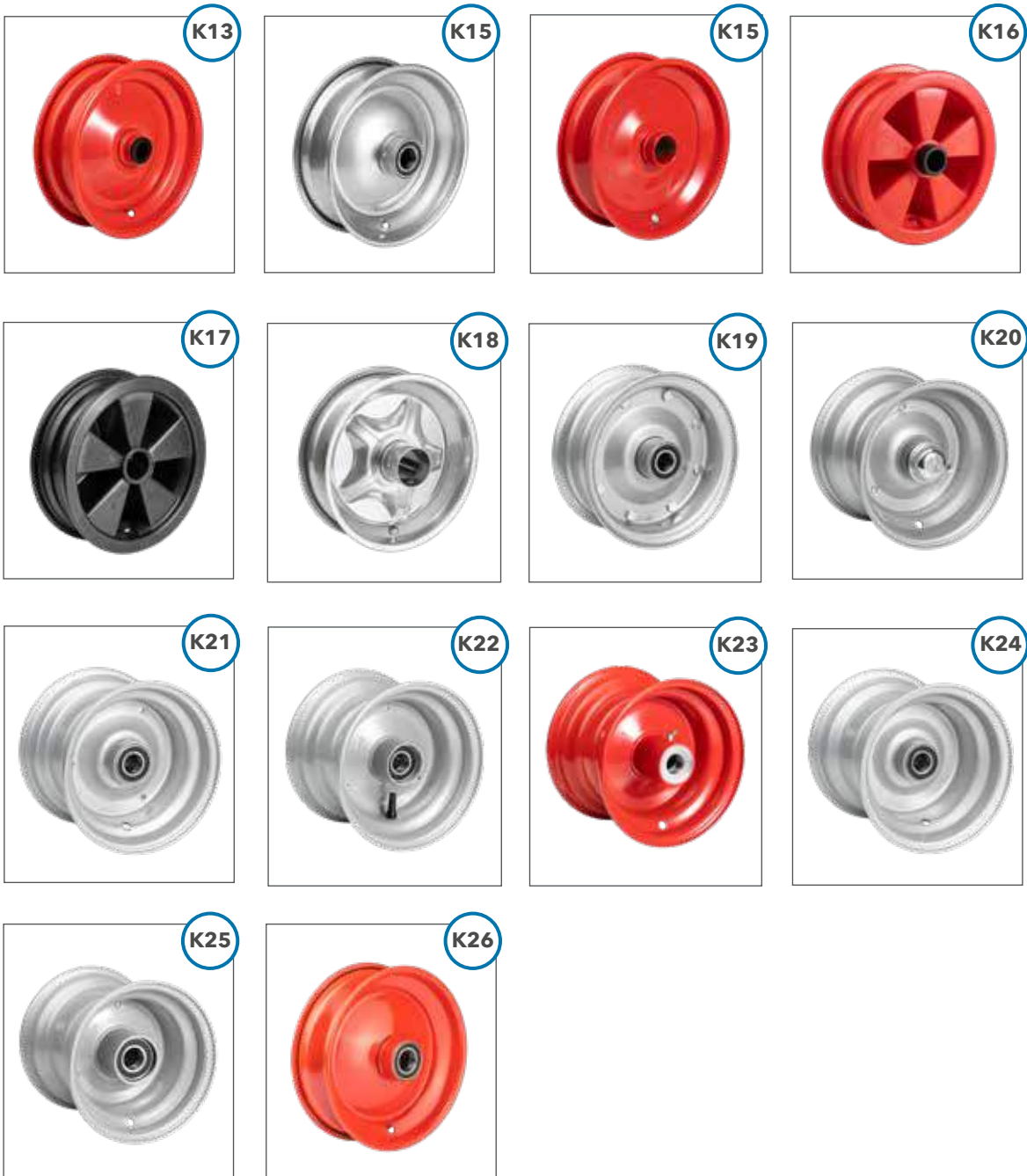



Implementfelgen

Preise und Bestände finden Sie unter www.bohnenkamp.de/shop

Artikel-Nr.	Felgenreöße	Anschluss	Bolzenlochausführung	Einpresstiefe	Tragfähigkeit [kg]	Geschwindigkeit [km/h]	Ventilschutz	Zusatzinfo
30895258	7.00 A x 8 H2	5/79.5/114.3	Ø12.5, C60, Kegel	0	525	40		JD gelb
30820090	4 J x 12	4/57/100	Ø15.5, R12, Kugel	0	600	40	VS H	
30820095	4 J x 12	4/57/100	Ø15.5, R12, Kugel	+26	300	30		
39600373	4.5 J x 12 H2	5/110/160	E1	0	690	40	VS H	
30820103	5 JA x 12	4/60/100	B1	+45	990	40		
30820104	5 JA x 12	4/60/100	E12	0	960	40		
30820102	5 JA x 12	5/67/112	B1	+40	990	40		
30820101	5 JA x 12	5/67/112	B1	+40	990	40	VS H	
30820100	5 JA x 12	5/67/112	E1	+25	800	40	VS H	
30855023	5.00 x 12	5/102/139.7	Ø15.5, R12, Kugel	-12	800	15	VS H	
39600418	7.00 l x 12 H2	5/80/114.3	Ø13	-10.5	900	40		
31610267	7.00 x 12	5/94/140	A1	-25	1500	40		rot RAL 3000
30810265	7.00 x 12	5/94/140	E1	0	500	80		
30820110	7.00 l x 12	5/94/140	A1	0	1500	40	VS H	
31610046	8.50 l x 12 H2	5/67/112	E1	0	900	40		
39600376	8.50 l x 12 H2	5/94/140	A1	0	1140	16		
39600378	8.50 l x 12 H2	5/94/140	Ø16, R14, Kugel	+27.5	875	40		
31610048	8.50 l x 12 H2	5/110/160	A1	0	1350	40		
30855024	8.50 x 12 H2	5/102/139.7	Ø15.5, R12, Kugel	-60	800	15	VS H	
30855028	8.50 x 12 H2	5/102/139.7	Ø15.5, R12, Kugel	-90	800	15	VS H	
30855027	8.50 JA x 12 H2	6/161/205	A2	0	950	40	VS H	rot RAL 3000
30855026	8.50 JA x 12 H2	6/161/205	Ø21.5, C90, Kegel	0	950	40	VS H	
30810301	10.50 l x 12 H2	4/60/100	A1	-70	800	40		
31610064	10.50 l x 12 H2	4/85/130	Ø14.5	-52.5	1120	40	VS H	4 Abflüßlöcher
31610052	10.50 l x 12 H2	5/66.6/112	A1	-70	1075	40		
31610062	10.50 l x 12 H2	5/66.6/112	E1	0	1000	40	VS H	
31610063	10.50 l x 12 H2	5/94/140	A1	-45	900	40	VS H	
31610061	10.50 l x 12 H2	5/94/140	A1	-30	1600	15	VS H	
31610051	10.50 l x 12 H2	5/94/140	E1	0	1360	40	VS H	
39600382	10.50 l x 12 H2	5/94/140	Ø16, R14, Kugel	+26.5	900	40		
30810302	10.50 l x 12 H2	6/161/205	E2	0	1600	25		
30055082	4.50 x 13 H2	5/94/140	A1	0	500	40		
30820120	5 J x 14	5/67/112	E1	0	1020	30		
31655241	6 J x 14 H2	6/161/205	E2	-5	1285	40		orange RAL 2002
31655247	6.75 x 14.5	6/161/205	A2	0	1500	40		
31610053	4 J x 15 H	5/110/160	A1	+30	750	40		Ventilloch Ø 15.7 mm
30855237	5 J x 15 H2	5/94/140	E1	0	600	40		rot RAL 3000
30855244	5 J x 15 H2	5/94/140	E1	0	900	40	VS H	
31610086	6 J x 15 H2	4/57/100	B1	+30	300	100		
33060010	6.00 x 15 H2	6/161/205	A2	+70	1600	50		

Artikel-Nr.	Felgenreöße	Anschluss	Bolzenloch- ausführung	Einpresstiefe	Tragfähigkeit [kg]	Geschwin- digkeit [km/h]	Ventil- schutz	Zusatzinfo
31610059	7 J x 15	5/66.6/112	B1	+30	1100	40	VS H	
30820135	7 J x 15	5/67/112	B1	+30	900	40	VS H	
31610054	7 J x 15	6/161/205	B2	-10	890	30		
31610055	7 J x 15	6/161/205	B2	+80	1300	40		
10001184	8 x 15	5/66.6/112	A1	-5	1100	40	VS H	
32010136	8 LB x 15	5/66.6/112	A1	-5	900	40	VS H	
31610083	8 W x 15	5/94/140	A1	0	900	40	VS H	
39600421	8 LB x 15 H2	5/94/140	A1	+30	1350	40		
32010134	8 LB x 15	6/161/205	B2	-40	1050	25	VS H	
33060023	10 x 15	5/94/140	A1	0	2500	40	VS H	
32010093	10 LB x 15 H2	6/161/205	A2	0	1200	30	VS H	
32010094	10 LB x 15 H2	6/161/205	B2	-35	1800	40	VS H	
32010092	10 LB x 15 H2	6/161/205	Ø21.5	-12.5	1550	40		JD gelb
32010324	13 LB x 15 H2	5/66.6/112	A1	-50	1500	40	VS H	
32010104	13 LB x 15 H2	5/66.6/112	A1	-37	900	40		
39920435	13 x 15	5/67/112	A1	-60	2800	40	VS H	
30810135	13 LB x 15 H2	5/66.5/112	A1	0	900	40		
32010308	13 LB x 15 H2	5/94/140	A1	-70	1000	40		
39600371	13 LB x 15 H2	5/192/225	A1	+83.5	1730	40		grau RAL 7042
32010100	13 LB x 15 H2	6/161/205	A2	-140	1250	50	VS H	
32010327	13 LB x 15 H2	6/161/205	A2	-105	200	40	VS H	
33060017	13 x 15	6/161/205	A2	-100	2800	40	VS H	
39920432	13 x 15	6/161/205	A2	-70	2800	40	VS H	
32010103	13 LB x 15 H2	6/161/205	A2	-55	2000	40		
39920431	13 x 15	6/161/205	A2	-50	2800	40	VS H	
33060039	13 x 15	6/161/205	A2	-37	2800	40	VS H	
32010113	13 LB x 15 H2	6/161/205	A2	-20	2000	20	VS H	
10000660	13 x 15	6/161/205	A2	-10	2800	40	VS H	
32010106	13 LB x 15 H2	6/161/205	A2	0	2000	40	VS H	
39920433	13 x 15	6/161/205	A2	0	2800	40	VS H	
33060016	13 x 15	6/161/205	A2	+70	2800	40	VS H	
30810150	13 LB x 15 H2	6/161/205	B2	0	2120	40	VS H	
32010118	13 LB x 15 H2	6/161/205	B2	0	2120	40	VS H	3 Ablauflöcher

VS H = Ventilschutz halbrund
 Standardlackierung für alle Felgen ist silber, wenn keine andere Farbe angegeben ist



Tiefbettfelgen in verschiedenen Ausführungen

Felge mit Ablauflöchern



Implementfelgen

Preise und Bestände finden Sie unter www.bohnenkamp.de/shop

Artikel-Nr.	Felgenreiße	Anschluss	Bolzenloch- ausführung	Einpresstiefe	Tragfähigkeit [kg]	Geschwindig- keit [km/h]	Ventil- schutz	Zusatzinfo
10000694	13 x 15	6/161/205	B2	+45	2500	50	VS H	
32010326	13 LB x 15 H2	6/161/205	E2	-85	1400	40	VS H	
32010325	13 LB x 15 H2	6/161/205	E2	-37	1400	40	VS H	
32010112	13 LB x 15 H2	6/161/205	Ø21.5	-32.5	1500	30		JD gelb
32010171	9.00 x 15.3	4/94/140	AA18	-50	1000	40		
32010020	9.00 x 15.3	5/66.5/112	A1	0	2060	40		
32010162	9.00 x 15.3	5/66.5/112	A1	+10	900	40		
10000948	9.00 x 15.3	5/66.5/112	B1	+40	2750	40	VS H	
30810182	9.00 x 15.3	5/94/140	A1	-32	2120	60		rot RAL 3000
32010163	9.00 x 15.3	5/94/140	E1	0	1650	60		
32010170	9.00 x 15.3	5/110/160	E1	-25	1650	60		
32010168	9.00 x 15.3	5/157/205	E1	0	1320	70		
33060021	9.00 x 15.3	6/161/205	A2	-25	2850	40	VS H	rot RAL 3000
31210095	9.00 x 15.3	6/161/205	A2	-5	3450	40		
33060026	9.00 x 15.3	6/161/205	A2	0	2850	40	VS H	
32010195	9.00 x 15.3	6/161/205	A2	0	3450	40	VS H	verstärkt
33060118	9.00 x 15.3	6/161/205	A2	+40	2750	40	VS H	anthrazit RAL 7016
10000086	9.00 x 15.3	6/161/205	A2	+55	2650	40	VS H	
30810181	9.00 x 15.3	6/161/205	B2	-40	2180	60	VS H	
32010180	9.00 x 15.3	6/161/205	B2	+40	2650	40		
30810185	9.00 x 15.3	6/161/205	B2	+80	2700	40		
32010181	9.00 x 15.3	6/161/205	E2	-5	2180	60		grau RAL 7035
32010190	9.00 x 15.3	6/161/205	E2	-5	2180	60		rot RAL 3000
31810195	9.00 x 15.3	6/161/205	E2	-5	2650	40		
10001072	9.00 x 15.3	6/161/205	E2	-5	2650	40		
31810196	9.00 x 15.3	6/161/205	E2	-5	2650	40	VS H	2 Ablauflöcher
32010177	9.00 x 15.3	6/161/205	E2	-5	2725	40	VS H	2 Ablauflöcher
32010178	9.00 x 15.3	6/161/205	E2	-5	2650	40	VS H	rot RAL 3000, 2 Ablauflöcher
32010185	9.00 x 15.3	6/161/205	E2	0	2725	40		
32010166	9.00 x 15.3	6/161/205	E2	+20	2360	40	VS H	
32010186	9.00 x 15.3	6/161/205	E2	+20	2360	40	VS H	anthrazit RAL 7016
33060027	9.00 x 15.3	8/190/210	Ø11	-10	3100	40	VS H	

VS H = Ventilschutz halbrund

Standardlackierung für alle Felgen ist silber, wenn keine andere Farbe angegeben ist



Tiefbettfelgen in verschiedenen Ausführungen

Felge mit Ablauflöchern

Artikel-Nr.	Felgenreöße	Anschluss	Bolzenloch- ausführung	Einpresstiefe	Tragfähigkeit [kg]	Geschwin- digkeit [km/h]	Ventil- schutz	Zusatzinfo
10000755	13.00 x 15.5	6/161/205	A2	-15	3750	40	VS H	
32010298	13.00 x 15.5	6/161/205	A2	0	3750	40	VS H	
32010306	13.00 x 15.5	6/161/205	A2	0	3500	40	VS H	2 Ablauflöcher
32010304	13.00 x 15.5	6/161/205	E2	0	3500	40	VS H	
33060113	13.00 x 15.5	10/176/225	A3	-15	3750	40	VS H	
31610174	4.00 E x 16	5/67/112	E1	0	290	40		
31610179	4.00 E x 16	5/110/160	B1	-36	500	30	VS H	
31610177	4.00 E x 16	5/110/160	E1	+36	300	30		
31610182	4.50 E x 16	4/94/140	Ø18	+40	750	40		
31610185	4.50 E x 16	5/66.6/112	B1	+40	650	40		
31410187	4.50 E x 16	5/66.6/112	E1	0	750	40		
31610184	4.50 E x 16	5/94/140	E1	+25	425	40		
31610186	4.50 E x 16	6/161/205	A2	0	1260	65	VS H	
31610071	5.50 F x 16	5/94/140	A1	+57	1000	40	VS H	
31610074	5.50 F x 16	5/94/140	E1	0	950	40	VS H	
31610075	5.50 F x 16	6/161/205	E2	0	1200	40		
33060102	W 8 x 16	5/94/140	A1	+10	1900	40	VS H	
31610080	8 W x 16	5/94/140	B1	-30	1250	30		
31610190	8 J x 16	6/161/205	A2	-5	1800	60		
30012034	11 x 16	6/161/205	A2	0	3550	40	VS H	
32010220	11 x 16	6/161/205	B2	-30	2800	60		
31660075	8.25 x 16.5	6/161/205	A2	0	2350	40	VS H	
10000926	8.25 x 16.5	6/161/205	A2	0	2350	40	VS H	
10000088	8.25 x 16.5	6/161/205	A2	+50	1600	20	VS H	
33060078	8.25 x 16.5	6/161/205	B2	-40	2360	40	VS H	
33060079	8.25 x 16.5	6/161/205	B2	+40	2350	40		
30012050	9.75 x 16.5	6/161/205	A2	0	2600	40		
39600996	9.75 x 16.5 H2	5/139.5/108	Ø17.5	-25	1030	40		
30012055	9.75 x 16.5	6/161/205	B2	+45	2350	40	VS H	
33060115	12.00 x 16.5	6/161/205	B2	+35	3750	40	VS H	

VS H = Ventilschutz halbrund

Standardlackierung für alle Felgen ist silber, wenn keine andere Farbe angegeben ist



Tiefbettfelgen in verschiedenen Ausführungen



Implementfelgen

Preise und Bestände finden Sie unter www.bohnenkamp.de/shop

Artikel-Nr.	Felgenreöße	Anschluss	Bolzenloch-ausführung	Einpresstiefe	Tragfähigkeit [kg]	Geschwin-digkeit [km/h]	Ventil-schutz	Zusatzinfo
33060116	13.00 x 17	6/161/205	A2	-85	3800	40	VS H	2 Abflüßlöcher
31612121	13.00 x 17	6/161/205	A2	-15	2600	40	VS H	
10000385	13.00 x 17	6/161/205	A2	-15	4150	40	VS H	
33060081	13.00 x 17	6/161/205	A2	0	3400	40	VS H	
33060076	13.00 x 17	6/161/205	A2	0	3400	40	VS H	2 Abflüßlöcher
33060117	13.00 x 17	6/161/205	B2	-54	2800	65	VS H	
33060077	13.00 x 17	6/161/205	B2	+45	3050	65	VS H	
10000695	13.00 x 17	6/161/205	B2	+85	4150	40	VS H	
32010322	13.00 x 17	6/161/205	E2	-85	3250	40	VS H	2 Abflüßlöcher
31612124	13.00 x 17	6/161/205	E2	-40	1950	40	VS H	
30012124	13.00 x 17	6/161/205	E2	0	3000	40		weiß RAL 9001
31610310	13.00 x 17	6/161/205	E2	0	3000	40	VS H	
30012129	13.00 x 17	6/161/205	E2	0	3300	40		gelb RAL 1007
32010311	13.00 x 17	6/161/205	E2	0	3300	40		JD gelb
32010315	13.00 x 17	8/221/275	A2	0	3300	40		
33060109	13.00 x 17	8/221/275	A2	0	3800	40	VS H	
33060073	13.00 x 17	8/221/275	A3	0	3400	40	VS H	
33060108	13.00 x 17	8/221/275	A3	+50	2900	40	VS H	
31610336	16.00 x 17	6/161/205	A2	-100	3250	65	VS H	
33060107	16.00 x 17	6/161/205	A2	-70	4150	40	VS H	
31610334	16.00 x 17	6/161/205	A2	-35	3250	65	VS H	
31610333	16.00 x 17	6/161/205	A2	0	3250	65		
30810333	16.00 x 17	6/161/205	A2	0	3250	65	VS H	rot RAL 3000
33060103	16.00 x 17	6/161/205	A2	0	4400	40	VS H	
31610348	16.00 x 17	8/221/275	A2	-35	3250	65	VS H	
31610322	16.00 x 17	8/221/275	A2	0	3250	65	VS H	
10000350	16.00 x 17	8/221/275	A2	0	4400	40	VS H	
31610324	16.00 x 17	8/221/275	A3	0	3000	65	VS H	
33060099	16.00 x 17	8/221/275	A3	0	4150	40	VS H	
39600419	9 x 18 H2	5/108/139.5	Ø17.5	-13	750	30		
32010138	9 x 18	6/161/205	A2	-30	3250	40	VS H	
32010135	9 x 18	6/161/205	A2	0	1800	80		
32010145	9 x 18	8/221/275	A2	0	3250	40		

VS H = Ventilschutz halbrund

Standardlackierung für alle Felgen ist silber, wenn keine andere Farbe angegeben ist



Tiefbettfelgen in verschiedenen Ausführungen

Felge mit Abflüßlöchern

Artikel-Nr.	Felgengröße	Anschluss	Bolzenloch- ausführung	Einpresstiefe	Tragfähigkeit [kg]	Geschwin- digkeit [km/h]	Ventil- schutz	Zusatzinfo
32010139	9 x 18	8/221/275	B3	0	3250	40	VS H	
31210146	11 x 18	6/161/205	A2	-50	3250	40	VS H	
31210145	11 x 18	6/161/205	A2	0	3000	80	VS H	
33060119	11 x 18	6/161/205	A2	+20	3850	40	VS H	
31210155	11 x 18	6/161/205	B2	-35	1800	80		
31210181	11 x 18	6/161/205	B2	+60	3000	40	VS H	
31210182	11 x 18	6/161/205	B2	+75	3000	40		
32010230	11 x 18	8/221/275	A2	0	3000	80	VS H	
33060090	11 x 18	8/221/275	A3	-80	3850	40	VS H	
32010232	11 x 18	8/221/275	A3	-50	4125	40	VS H	
33060091	11 x 18	8/221/275	A3	-40	3850	40	VS H	
33060097	11 x 18	8/221/275	A3	-10	3150	90	VS H	
31612155	11 x 18	8/221/275	A3	0	3650	40	VS H	
33060089	11 x 18	8/221/275	A3	+30	3150	90	VS H	
33060104	11 x 18	8/221/275	A3	+40	3850	40	VS H	
31612158	11 x 18	8/221/275	A3	+50	2500	50	VS H	
31210162	11 x 18	8/221/275	B3	-35	2650	60	VS H	
33060084	13 x 18	6/161/205	A2	0	3850	40	VS H	
30812410	13 x 18	6/161/205	B2	-40	2900	60		
32010281	13 x 18	8/221/275	A3	0	3350	60		
31612165	13 x 18	8/221/275	A3	0	4300	30	VS H	
33060096	13 x 18	8/221/275	B3	+40	3150	40	VS H	
33060105	13 x 18	8/221/275	Ø24	+45	3850	40	VS H	grau RAL 7024
32010110	5.50 F x 20	6/161/205	A2	0	1500	40		
32010250	11 x 20	6/161/205	A2	0	1600	80		
32010255	11 x 20	6/161/205	B2	+50	2000	80		
30812430	11 x 20	8/221/275	A2	0	3875	40		
31610350	11 x 20	8/221/275	A3	0	3750	40	VS H	
32010265	11 x 20	8/221/275	A3	0	3875	40		
32010266	11 x 20	8/221/275	A3	+22	3750	40	VS H	
30812460	13 x 20	6/161/205	A2	-45	3625	40		
33060169	13 x 20	6/161/205	A2	0	4000	40	VS H	
30812465	13 x 20	8/221/275	B2	-50	4250	50	VS H	

VS H = Ventilschutz halbrund
 Standardlackierung für alle Felgen ist silber, wenn keine andere Farbe angegeben ist



Implementfelgen

Preise und Bestände finden Sie unter www.bohnenkamp.de/shop

Artikel-Nr.	Felgenreiße	Anschluss	Bolzenloch- ausführung	Einpresstiefe	Tragfähigkeit [kg]	Geschwin- digkeit [km/h]	Ventil- schutz	Zusatzinfo
33060162	13 x 20	8/221/275	A3	0	4000	40	VS H	
33060163	13 x 20	8/221/275	A3	+10	4000	40	VS H	
33060164	13 x 20	8/221/275	A3	+30	4000	40	VS H	
33060165	W 13 x 20	8/221/275	A3	+70	4250	40	VS H	
33060161	13 x 20	8/221/275	B3	+30	3300	90	VS H	anthrazit RAL 7016
31610330	14 x 20	6/161/205	A2	0	3200	40	VS H	rot RAL 3000
32010330	14 x 20	6/161/205	A2	0	3875	60		
31610347	14 x 20	8/221/275	A2	0	3330	40	VS H	rot RAL 3000
30812500	14 x 20	8/221/275	A2	0	3875	40		
30812490	14 x 20	8/221/275	B2	-40	3875	40		
31610340	14 x 20	8/221/275	A3	0	3330	40		rot RAL 3000
31610343	14 x 20	8/221/275	A3	0	3900	40	VS H	
10001216	14 x 20	8/221/275	B3	-60	4250	40	VS H	
31610341	14 x 20	8/221/275	B3	-50	3900	40	VS H	
10000827	14 x 20	10/281/335	B3	-100	4250	40		rot RAL 3000
33060174	16 x 20	6/161/205	A2	0	4500	40	VS H	
30810400	16 x 20	8/221/275	A2	-50	3500	50		
31610392	16 x 20	8/221/275	A2	0	5000	40		
33060177	16 x 20	8/221/275	A2	0	5800	40	VS H	weiß RAL 9001
31610610	16 x 20	8/221/275	A3	0	5000	40	VS H	
33060176	16 x 20	8/221/275	A3	0	5800	40	VS H	
33060173	16 x 20	8/221/275	B3	+50	5800	40	VS H	
31610601	16 x 20	10/281/335	A3	0	5000	40		

VS H = Ventilschutz halbrund

Standardlackierung für alle Felgen ist silber, wenn keine andere Farbe angegeben ist

Artikel-Nr.	Felgenreöße	Anschluss	Bolzenloch- ausführung	Einpresstiefe	Tragfähigkeit [kg]	Geschwin- digkeit [km/h]	Ventil- schutz	Zusatzinfo
31612756	W 13 x 24	6/161/205	B2	+80	2600	40	VS H	
31612755	DW 13 x 24	8/221/275	A2	0	3550	50	VS H	
33060458	DW 13 L x 24	8/221/275	A2	0	4750	40	VS H	
31612751	DW 13 x 24	10/281/335	B3	+85	4250	40	VS H	
32010402	DW 20 B x 26	10/281/335	B3	0	5400	40		verstärkt
32010433	DW 25 B x 26	10/281/335	A3	0	7100	60		

VS H = Ventilschutz halbrund

Standardlackierung für alle Felgen ist silber, wenn keine andere Farbe angegeben ist



Tiefbettfelgen in verschiedenen Ausführungen

Felge mit Ablauflöchern





Implementfelgen LKW

Preise und Bestände finden Sie unter www.bohnenkamp.de/shop

Artikel-Nr.	Felgenreöße	Anschluss	Bolzenloch- ausführung	Einpresstiefe	Tragfähigkeit [kg]	Geschwin- digkeit [km/h]	Ventil- schutz	Zusatzinfo
31612132	11.75 x 17.5	6/161/205	A2	-15	3250	40	VS H	
33060110	14.00 x 17.5	6/161/205	A2	0	5200	40	VS H	
33060111	14.00 x 17.5	8/221/275	A2	0	5200	40		
33060112	14.00 x 17.5	10/176/225	A3	0	5200	40	VS H	
31267891	13.00 x 19.5	6/161/205	A2	0	4625	60		
31267890	13.00 x 19.5	8/221/275	A3	0	4500	80		
30860095	14.00 x 19.5	6/161/205	B2	0	2000	70		
30860110	14.00 x 19.5	8/221/275	A2	0	4500	80		
31267914	14.00 x 19.5	8/221/275	A2	0	4875	65		rot RAL 3000
31267918	14.00 x 19.5	8/221/275	A2	0	5150	65		
30860100	14.00 x 19.5	8/221/275	A3	0	4500	80		
31267916	14.00 x 19.5	8/221/275	A3	+40	5300	40	VS H	
30860140	14.00 x 19.5	10/176/225	A3	0	4500	80		
31660145	14.00 x 19.5	10/281/335	A3	0	4500	80		
31610170	7.50 x 22.5	6/161/205	A2	0	3000	100		
33060245	9.00 x 22.5	6/161/205	A2	-10	2500	80		
33060275	11.75 x 22.5	6/161/205	A2	0	5200	80	VS H	
33060276	11.75 x 22.5	6/161/205	A2	0	5200	80	VS H	rot RAL 3000
33060253	11.75 x 22.5	6/161/205	B2	-40	4700	80	VS H	
31612560	11.75 x 22.5	8/221/275	A2	0	4500	80		
33060271	11.75 x 22.5	8/221/275	A3	+70	4750	100		
10000227	11.75 x 22.5	8/221/275	B3	-50	4650	80	VS H	
33060277	11.75 x 22.5	10/281/335	B3	-100	4800	80		rot RAL 3000
33060278	11.75 x 22.5	10/281/335	B3	-85	5000	80	VS H	schwarz RAL 9011
33060273	11.75 x 22.5	10/281/335	B3	0	4750	40		rot RAL 3000
31612575	14.00 x 22.5	8/221/275	A3	-100	4875	40	VS H	
30840310	14.00 x 22.5	8/221/275	A3	0	4500	80		
10000802	14.00 x 22.5	8/221/275	B3	-100	6400	40	VS H	
10000596	14.00 x 22.5	8/221/275	B3	-50	5150	100	VS H	
30840320	14.00 x 22.5	10/281/335	A3	0	4500	80		

VS H = Ventilschutz halbrund

Standardlackierung für alle Felgen ist silber, wenn keine andere Farbe angegeben ist



Tiefbettfelgen in verschiedenen Ausführungen

Felge mit Ablauflöchern

Flotationfelgen

Artikel-Nr.	Felgenreöße	Anschluss	Bolzenloch- ausführung	Einpresstiefe	Tragfähigkeit [kg]	Geschwin- digkeit [km/h]	Ventil- schutz	Zusatzinfo
33060371	16.00 x 22.5 H2	6/161/205	A2	-95	5300	65	VS H	12 mm Schüssel
31612651	16.00 x 22.5 TH2	6/161/205	A2	-50	4375	40		
33060368	16.00 x 22.5 H2	6/161/205	A2	-15	5000	65	VS H	
31612606	16.00 x 22.5 TH2	6/161/205	A2	0	4375	40	VS H	rot RAL 3000
33060357	16.00 x 22.5 H2	6/161/205	A2	0	5000	65	VS H	
31612625	16.00 x 22.5 TH2	6/161/205	B2	+40	1000	20	VS H	
31612676	16.00 x 22.5 H2	8/221/275	A2	-50	5150	65	VS H	
33060418	16.00 x 22.5 H2	8/221/275	A2	-35	5600	65	VS H	
31612621	16.00 x 22.5 TH2	8/221/275	A2	0	4800	65		
31612675	16.00 x 22.5 H2	8/221/275	A2	0	5150	65	VS H	
30812620	16.00 x 22.5 TH2	8/221/275	A2	0	5300	65		
10001304	16.00 x 22.5 H2	8/221/275	A2	0	5300	65	VS H	
33060349	16.00 x 22.5 H2	8/221/275	B2	-80	6050	50	VS H	
33060353	16.00 x 22.5 H2	8/221/275	B2	-50	5000	65	VS H	
30812608	16.00 x 22.5 TH2	8/221/275	A3	-50	5300	65	VS H	
33060364	16.00 x 22.5 H2	8/221/275	A3	-50	5300	65	VS H	
31612603	16.00 x 22.5 TH2	8/221/275	A3	0	4800	65	VS H	
39122835	16.00 x 22.5 H2	8/221/275	A3	0	5270	65	VS H	schwarz RAL 7021
33060358	16.00 x 22.5 H2	8/221/275	A3	0	5300	65	VS H	
33060376	16.00 x 22.5 H2	8/221/275	A3	0	6800	40	VS H	anthrazit RAL 7016
33060367	16.00 x 22.5 H2	8/221/275	A3	+10	5000	65	VS H	
33060373	16.00 x 22.5 H2	8/221/275	A3	+50	5300	65	VS H	
30812623	16.00 x 22.5 TH2	8/221/275	B3	-100	4500	80	VS H	rot RAL 3000
33060363	16.00 x 22.5 H2	8/221/275	B3	-33	4500	65	VS H	
30812686	16.00 x 22.5 TH2	8/221/275	B3	+70	5450	40		rot RAL 3000
33060366	16.00 x 22.5 H2	10/281/335	A3	-100	5300	65	VS H	
31612673	16.00 x 22.5 H2	10/281/335	A3	-50	5150	65	VS H	
30812681	16.00 x 22.5 TH2	10/281/335	A3	-50	5300	65		
31612631	16.00 x 22.5 TH2	10/281/335	A3	0	4800	65		
30812682	16.00 x 22.5 TH2	10/281/335	A3	0	5300	65		gelb RAL 1007
33060354	16.00 x 22.5 H2	10/281/335	A3	0	5600	65	VS H	
33060369	16.00 x 22.5 H2	10/281/335	A3	0	5400	65	VS H	schwarz RAL 9005
33060372	16.00 x 22.5 H2	10/281/335	A3	0	5400	65	VS H	rot RAL 3000

VS H = Ventilschutz halbrund

Standardlackierung für alle Felgen ist silber, wenn keine andere Farbe angegeben ist



Steilschulterfelgen





Flotationfelgen

Preise und Bestände finden Sie unter www.bohnenkamp.de/shop

Artikel-Nr.	Felgenreöße	Anschluss	Bolzenlochausführung	Einpresstiefe	Tragfähigkeit [kg]	Geschwindigkeit [km/h]	Ventilschutz	Zusatzinfo
30812601	16.00 x 22.5 TH2	10/281/335	A3	+50	5300	65		
30812636	16.00 x 22.5 TH2	10/281/335	A3	+50	5300	65	VS H	gelb RAL 1007
10000659	16.00 x 22.5 H2	10/281/335	A3	+70	5300	65	VS H	anthrazit RAL 7016
33060359	16.00 x 22.5 H2	10/281/335	B3	-85	5300	65	VS H	
33060361	16.00 x 22.5 H2	10/281/335	B3	-50	5300	65	VS H	
33060370	16.00 x 22.5 H2	10/281/335	B3	-50	5300	65	VS H	schwarz RAL 9005
33060365	16.00 x 22.5 H2	10/281/335	B3	+30	5300	65	VS H	
31612648	16.00 x 22.5 TH2	10/281/335	B3	+80	4800	65		
33060414	20.00 x 22.5 H2	6/161/205	A2	-50	5600	65	VS H	
32012682	20.00 x 22.5 TH2	8/221/275	A2	-50	5310	65		
10001300	20.00 x 22.5 H2	8/221/275	A2	-50	5600	65	VS H	
33060406	20.00 x 22.5 H2	8/221/275	A2	0	5600	65		
10001299	20.00 x 22.5 H2	8/221/275	B2	+95	5600	65	VS H	
32012687	20.00 x 22.5 TH2	8/221/275	A3	-50	5310	65		
33060413	20.00 x 22.5 H2	8/221/275	A3	-50	5600	65	VS H	
32012689	20.00 x 22.5 TH2	8/221/275	A3	-50	5750	65		rot RAL 3000
33060409	20.00 x 22.5 H2	8/221/275	A3	0	5600	65	VS H	
32012685	20.00 x 22.5 TH2	10/281/335	A3	-100	5310	65		
10001372	20.00 x 22.5 H2	10/281/335	A3	-100	5600	65	VS H	
32012686	20.00 x 22.5 TH2	10/281/335	A3	-50	5310	65	VS H	
33060407	20.00 x 22.5 H2	10/281/335	A3	-50	5600	65	VS H	
33060416	20.00 x 22.5 H2	10/281/335	A3	-50	5600	65	VS H	schwarz RAL 9005
10000140	20.00 x 22.5 H2	10/281/335	A3	-10	14310	65	VS H	grau RAL 7011
32012683	20.00 x 22.5 TH2	10/281/335	A3	0	5310	65		
33060408	20.00 x 22.5 H2	10/281/335	A3	0	5600	65	VS H	
10001283	20.00 x 22.5 H2	10/281/335	A3	0	5600	65	VS H	
32013088	20.00 x 22.5 H2	10/281/335	B3	+50	5180	65	VS H	
10001188	20.00 x 22.5 H2	10/281/335	B3	+50	5600	65	VS H	
33060412	20.00 x 22.5 H2	10/281/335	Ø26, M22	-50	5100	100	VS H	
33060411	20.00 x 22.5 H2	10/281/335	Ø26, M22	0	5100	100	VS H	
32012782	24.00 x 22.5 TH2	8/221/275	A2	-50	6640	65		
33060456	24.00 x 22.5 H2	8/221/275	A2	-50	6800	65	VS H	
33060452	24.00 x 22.5 H2	8/221/275	A3	-50	6000	65	VS H	

VS H = Ventilschutz halbrund

Standardlackierung für alle Felgen ist silber, wenn keine andere Farbe angegeben ist



Steilschulterfelgen

Artikel-Nr.	Felgenreöße	Anschluss	Bolzenloch- ausführung	Einpresstiefe	Tragfähigkeit [kg]	Geschwin- digkeit [km/h]	Ventil- schutz	Zusatzinfo
32012789	24.00 x 22.5 TH2	8/221/275	A3	-50	6640	65		
32012793	24.00 x 22.5 TH2	8/221/275	A3	-50	6640	65		Fendt Terra rot
33060453	24.00 x 22.5 H2	8/221/275	A3	0	6500	65	VS H	
33060455	24.00 x 22.5 H2	8/221/275	A3	+50	6000	65	VS H	
32012785	24.00 x 22.5 TH2	10/281/335	A3	-100	6640	65		
32012784	24.00 x 22.5 TH2	10/281/335	A3	-50	6640	65		
33060462	24.00 x 22.5 H2	10/281/335	A3	-50	6800	65	VS H	
32012783	24.00 x 22.5 TH2	10/281/335	A3	0	6640	65		
33060461	24.00 x 22.5 H2	10/281/335	A3	0	6800	65	VS H	
33060457	24.00 x 22.5 H2	10/281/335	B3	+50	6000	65	VS H	rot RAL 3000
33060459	28.00 x 22.5 H2	8/221/275	A3	-75	5800	65	VS H	
10000696	25 x 26	12/372/425	A3	-70	7300	40	VS H	anthrazit RAL 7016
32012881	20.00 x 26.5 TH2	8/221/275	A2	-50	6500	65		
32012880	20.00 x 26.5 TH2	8/221/275	A2	0	6500	65		
10001303	20.00 x 26.5 H2	8/221/275	A2	0	7500	65	VS H	
32012883	20.00 x 26.5 TH2	10/281/335	A3	-50	7500	65		
32012893	20.00 x 26.5 H2	10/281/335	A3	-50	7500	65	VS H	Fendt Terra rot
32012882	20.00 x 26.5 TH2	10/281/335	A3	0	7500	65		
32012885	20.00 x 26.5 TH2	10/281/335	A3	+50	6500	65		
10001302	20.00 x 26.5 H2	10/281/335	A3	+50	7500	65	VS H	
33060551	20.00 x 26.5 H2	10/281/335	B3	-50	7500	65	VS H	
33060561	20.00 x 26.5 H2	10/281/335	B3	-50	7500	65	VS H	schwarz RAL 9005
33060559	20.00 x 26.5 H2	10/281/335	B3	0	7500	65	VS H	
33060560	20.00 x 26.5 H2	10/281/335	B3	0	7500	65	VS H	schwarz RAL 9005
32012884	20.00 x 26.5 TH2	10/281/335	B3	+30	6500	65		
33060555	20.00 x 26.5 H2	10/281/335	B3	+30	7500	65	VS H	
10000084	20.00 x 26.5 H2	10/281/335	B3	+30	7500	65	VS H	schwarz RAL 9005
33060558	20.00 x 26.5 H2	12/371/425	A3	-40	7500	65	VS H	anthrazit RAL 7016
10001332	24.00 x 26.5 H2	8/221/275	A2	-50	7750	65	VS H	
32012900	24.00 x 26.5 TH2	8/221/275	A2	0	6300	65		
32012904	24.00 x 26.5 TH2	10/281/335	A3	-100	7500	65		

VS H = Ventilschutz halbrund
Standardlackierung für alle Felgen ist silber, wenn keine andere Farbe angegeben ist



Steilschulterfelgen



Flotationfelgen

Preise und Bestände finden Sie unter www.bohnenkamp.de/shop

Artikel-Nr.	Felgenreöße	Anschluss	Bolzenloch- ausführung	Einpresstiefe	Tragfähigkeit [kg]	Geschwin- digkeit [km/h]	Ventil- schutz	Zusatzinfo
32012892	24.00 x 26.5 TH2	10/281/335	A3	-75	6500	65		
32012903	24.00 x 26.5 TH2	10/281/335	A3	-50	7500	65		
32012916	24.00 x 26.5 TH2	10/281/335	A3	-50	7500	65		schwarz RAL 9005
33060574	24.00 x 26.5 H2	10/281/335	A3	-50	7750	65	VS H	
33060569	24.00 x 26.5 H2	10/281/335	A3	-50	7750	65	VS H	schwarz RAL 9005
33060570	24.00 x 26.5 H2	10/281/335	A3	0	7100	65	VS H	
33060568	24.00 x 26.5 H2	10/281/335	A3	0	7100	65	VS H	schwarz RAL 9005
32012902	24.00 x 26.5 TH2	10/281/335	A3	0	7500	65		
33060572	24.00 x 26.5 H2	10/281/335	A3	0	7850	65	VS H	
32012911	24.00 x 26.5 TH2	10/281/335	A3	+25	6300	60		
10001187	24.00 x 26.5 H2	10/281/335	B3	+50	7750	65	VS H	
32012912	24.00 x 26.5 TH2	10/281/335	B3	0	6150	70		
33060576	24.00 x 26.5 H2	12/371/425	A3	-85	8000	65	VS H	anthrazit RAL 7016
32013032	28.00 x 26.5 TH2	10/281/335	A3	-100	7300	65		
32013031	28.00 x 26.5 TH2	10/281/335	A3	-50	7300	65		
33060801	28.00 x 26.5 H2	10/281/335	A3	-50	7600	65	VS H	
32013030	28.00 x 26.5 TH2	10/281/335	A3	0	7300	65		
33060802	28.00 x 26.5 H2	10/281/335	A3	0	7600	65	VS H	
32013096	20.00 x 30.5 TH2	10/281/335	A3	-50	7750	65		
32013095	20.00 x 30.5 TH2	10/281/335	A3	0	7750	65		
33060700	20.00 x 30.5 H2	10/281/335	A3	0	8000	65	VS H	
32100758	20.00 x 30.5 H2	12/371/425	A3	-10	11962	65		
32013122	24.00 x 30.5 TH2	10/281/335	A3	-100	8050	70		
32013121	24.00 x 30.5 TH2	10/281/335	A3	-50	8250	65		
33060826	24.00 x 30.5 H2	10/281/335	A3	-50	8500	65	VS H	
32013120	24.00 x 30.5 TH2	10/281/335	A3	0	8250	65		
32013130	24.00 x 30.5 H2	10/281/335	A3	0	8250	65	VS H	schwarz RAL 9005
33060825	24.00 x 30.5 H2	10/281/335	A3	0	8500	65	VS H	
33060853	24.00 x 30.5 H2	10/281/335	A3	+60	8500	65	VS H	

VS H = Ventilschutz halbrund

Standardlackierung für alle Felgen ist silber, wenn keine andere Farbe angegeben ist



Steilschulterfelgen

Artikel-Nr.	Felgenreöße	Anschluss	Bolzenloch- ausführung	Einpresstiefe	Tragfähigkeit [kg]	Geschwin- digkeit [km/h]	Ventil- schutz	Zusatzinfo
32013127	24.00 x 30.5 TH2	10/281/335	A3	+150	8490	65		rot RAL 3000
10001301	24.00 x 30.5 H2	10/281/335	A3	+150	8500	65	VS H	rot RAL 3000
33060851	28.00 x 30.5 H2	10/281/335	A3	-50	8700	65	VS H	
33060852	28.00 x 30.5 H2	10/281/335	A3	0	8700	65	VS H	
33060849	28.00 x 30.5 H2	10/281/335	B3	+40	8700	65	VS H	
32013513	27 x 32	10/281/335	B3	-50	10000	65		
32013515	27 x 32	10/281/335	B3	0	10000	65		
32013511	27 x 32	10/281/335	B3	+30	10000	65		

VS H = Ventilschutz halbrund

Standardlackierung für alle Felgen ist silber, wenn keine andere Farbe angegeben ist



Steilschulterfelgen





Felgen und Anschlüsse für Reifendruckregelanlage

Preise und Bestände finden Sie unter www.bohnenkamp.de/shop

Artikel-Nr.	Felgenreöße	Anschluss	Bolzenloch- ausführung	Einpress- tiefe	Tragfähigkeit [kg]	Geschwindigkeit [km/h]	Zusatzinfo
32013123	24.00 x 30.5 TH2	10/281/335	A3	0	8250	65	Zusatzloch Ø 27.5 mm
32013514	27 x 32	10/281/335	B3	0	12240	40	Zusatzloch Ø 27.5 mm
32013573	36.00 - 32/1,7	10/281/335	A3	0	9250	40	Zusatzloch Ø 27.5 mm

Anschlüsse für Reifendruckregelanlage

Artikel-Nr.	Artikelbeschreibung
44500001	Kugelhahn mit Handhebel , Nylon Dichtring für G 1/2" und Verschlusschraube
44500004	Verschraubung
44500005	Ventildurchführung
44500006	Edelstahlmutter für G 1/2"
44500007	Scheibe VA - M20
44500008	Verschlusskappe
44500010	Montagesatz für Reifendruckregelanlage (Verschraubung, Dichtung, Mutter, Kugelhahn\Verschlusschraube, Dichtring)
44500011	Montagesatz für Reifendruckregelanlage (Verschraubung, Dichtung, Mutter \ Verschlusschraube)
44803333	Inbus-Verschlussstopfen G3/8" mit O-Ring \ für Reifendruckregelanlage
44803340	PTG Steckkupplung Adapter für Boka RDA \ Airbooster System, 3/8" Außengewinde
44803341	Steckkupplung Adapter für Boka RDA, 3/8" Außengewinde \ NW 7,2 \ Edelstahl
44803344	Einschraubwinkel 90°\2 X 3/8" Außengewinde \ Edelstahl
44803345	Schutzkappe SK25 \ mit Kordel und Schlaufe
41295006	Airbooster Reifenfüll- und Schnellentlüftungs-Set im Tragekoffer
47201038	Agrar Felgenventil TR618, Wasserventil zum Schrauben
60009010	Schnell-Entlüftungsventil \ inkl. Schutzkappe und Dichtsatz \ zum Aufschrauben *Viererpack*
60009011	Aufschraubnippel für RDA \ inkl. Schutzkappe *Viererpack*, PTG



44500001 | Kugelhahn



44500004 | Verschraubung



44500005 | Ventildurchführung

Alles auf einen Blick:



44500006 | Edelstahlmutter VA für G 1/2"



44500007 | Scheibe VA - M20



44500008 | Verschlusskappe



44500010 | Montagesatz für RDA



44500011 | Montagesatz für RDA



44803333 | Inbus-Verschlussstopfen



44803340 | PTG Steckkupplung



44803341 | Steckkupplung Adapter



44803344 | Einschraubwinkel 90°



44803345 | Schutzkappe SK25



41295006 | Airbooster



47201038 | Agrar Felgenventil TR618



60009010 | Schnell-Entlüftungsventil



60009011 | Aufschraubnippel



Anschlüsse für Reifendruckregelanlage

Preise und Bestände finden Sie unter www.bohenkamp.de/shop

Montagesatz mit Kugelhahn



bestehend aus:

- 44500001 | Kugelhahn
- 44500004 | Verschraubung
- 44500005 | Ventildurchführung
- 44500006 | Mutter VA für G 1/2"
- 44500007 | Scheibe VA - M20

Montagesatz mit Verschlussstopfen



bestehend aus:

- 44500004 | Verschraubung
- 44500005 | Ventildurchführung
- 44500006 | Mutter VA für G 1/2"
- 44500007 | Scheibe VA - M20
- 44803333 | Inbus-Verschlussstopfen

Montagesatz mit Steckkupplung Adapter



bestehend aus:

- 44500004 | Verschraubung
- 44500005 | Ventildurchführung
- 44500006 | Mutter VA für G 1/2"
- 44500007 | Scheibe VA - M20
- 44803341 | Steckkupplung Adapter Edelstahl
- 44803345 | Schutzkappe

Montagesatz mit PTG Steckkupplung



bestehend aus:

- 44500004 | Verschraubung
- 44500005 | Ventildurchführung
- 44500006 | Mutter VA für G 1/2"
- 44500007 | Scheibe VA - M20
- 44803340 | PTG Steckkupplung
- 44803345 | Schutzkappe

Montagesatz mit Winkel und Steckkupplung Adapter



bestehend aus:

- 44500004 | Verschraubung
- 44500005 | Ventildurchführung
- 44500006 | Mutter VA für G 1/2"
- 44500007 | Scheibe VA - M20
- 44803344 | Einschraubwinkel
- 44803341 | Steckkupplung Adapter Edelstahl
- 44803345 | Schutzkappe

Montagesatz mit Winkel und PTG Steckkupplung



bestehend aus:

- 44500004 | Verschraubung
- 44500005 | Ventildurchführung
- 44500006 | Mutter VA für G 1/2"
- 44500007 | Scheibe VA - M20
- 44803344 | Einschraubwinkel
- 44803340 | PTG Steckkupplung
- 44803345 | Schutzkappe



Wichtiger Hinweis

Wichtig:
Gewinde stets mit geeignetem Dichtmittel abdichten!

Montagesatz mit Winkel und Verschlussstopfen



bestehend aus:

- 44500004 | Verschraubung
- 44500005 | Ventildurchführung
- 44500006 | Mutter VA für G 1/2"
- 44500007 | Scheibe VA - M20
- 44803344 | Einschraubwinkel
- 44803333 | Inbus-Verschlussstopfen

Montagesatz mit Felgenventil und Aufschraubnippel



bestehend aus:

- 47201038 | Agrar Felgenventil TR618
- 60009011 | Aufschraubnippel

für Airbooster Plus

Montagesatz mit Felgenventil und Schnell-Entlüftungsventil



bestehend aus:

- 47201038 | Agrar Felgenventil TR618
- 60009010 | Schnell-Entlüftungsventil

für Airbooster



Abb. ähnlich

Anschluss für Reifendruckregelanlage mit **Verschlusskappe**

oder



Abb. ähnlich

Anschluss für Reifendruckregelanlage mit **Adapter**

Alle gängigen Adapter auf Anfrage ab Lager lieferbar!

Weitere Möglichkeiten



Rohrmuffe mit 1/2" oder 3/8" Innengewinde im Felgenring



Extra Loch mit Gewinde 1/2" oder 3/8" im Felgenring

+ inklusive Inbus-Verschlussstopfen

Weitere Vorteile von Reifendruckregelanlagen

- Geringerer Kraftstoffverbrauch
- Schneller und einfacher Luftdruckwechsel
- Optimale Bodenschonung

Weitere individuell auf den Kunden angepasste Lösungen auf Anfrage möglich !



Forstfelgen

Preise und Bestände finden Sie unter www.bohnenkamp.de/shop

Artikel-Nr.	Felgenreöße	Anschluss	Bolzenloch- ausführung	Einpress- tiefe	Tragfähigkeit [kg]	Geschwindigkeit [km/h]	Ventilschutz	Zusatzinfo
33060082	13.00 x 15.5	6/161/205	A2	-15	3450	40	VSV	Ø16 mm Hornverstärkung
33060033	13.00 x 15.5	6/161/205	A2	0	3350	40	VSV	Ø16 mm Hornverstärkung
33060047	16.00 x 17	6/161/205	A2	-50	3550	40	VSV	Ø12 mm Hornverstärkung
33060071	16.00 x 17	6/161/205	A2	-35	4400	40	VSV	Ø12 mm Hornverstärkung
33060041	16.00 x 17	6/161/205	A2	0	4400	40	VSV	Ø12 mm Hornverstärkung
33060046	16.00 x 17	8/221/275	A2	-50	4600	40	VSV	Ø12 mm Hornverstärkung
33060083	16.00 x 17	8/221/275	A2	-35	4400	40	VSV	Ø12 mm Hornverstärkung
33060085	16.00 x 17	8/221/275	A2	0	4600	40	VSV	Ø12 mm Hornverstärkung
33060352	16.00 x 22.5 H2	8/221/275	A2	-50	5000	65	VSV	Ø16 mm Hornverstärkung
33060356	16.00 x 22.5 H2	8/221/275	A2	0	5800	65	VSV	Ø16 mm Hornverstärkung
33060360	20.00 x 22.5 H2	8/221/275	A2	-100	5000	65	VSV	Ø16 mm Hornverstärkung

Industriefelgen

Artikel-Nr.	Felgenreöße	Anschluss	Bolzenloch- ausführung	Einpress- tiefe	Tragfähigkeit [kg]	Geschwindigkeit [km/h]
39920126	3.00 D - 8	4/60/100	Ø13.5, C60, Kegel	0	925	10
30655026	3.00 D - 8	5/67/112	G12, Ø16, R12, Kugel	0	930	25
30895205	4.33 R - 8	5/94/140	G1, Ø18.5, R14 Kugel	0	1650	40
39600158	7.00 A x 8	4/60/100	Ø13.5, C60 Kegel	-22.5	470	20
30691315	4.00 E - 9	5/67/112	G12, Ø16, R12 Kugel	-5	1150	40
31695102	6.00 E - 9	5/110/160	A1	-10	1885	40
31610007	6.50 F - 10	5/94/140	A1	0	2500	40
31610008	6.50 F - 10	7/110/145	A1	+35	2650	25
31610041	5.00 S - 12	6/161/205	A2	0	1900	40
39600377	7.00 I x 12	10/93/140	Ø16.5	+20	975	10
31610043	8.00 G - 12	6/161/205	A2	0	3250	40
33060032	8.0 - 15	8/221/275	A3	0	6000	25

VS H = Ventilschutz halbrund

Standardlackierung für alle Felgen ist silber, wenn keine andere Farbe angegeben ist

EM-Felgen

Artikel-Nr.	Felgenreöße	Anschluss	Bolzenloch-ausführung	Einpress-tiefe	HMA	Tragfähigkeit [kg]	Geschwindig-keit [km/h]	Ventil-schutz	Zusatzinfo
31610066	9.75 - 15	8/221/275	A2	0		3250	40		
33060147	7.0 - 20	8/221/275	B3	+141	153	6000	25		schwarz RAL 9005
33060146	7.0 - 20	10/281/335	B3	+141	153	6000	25		schwarz RAL 9005
33060153	7.5 - 20	8/221/275	B3	+153	165	6500	25		schwarz RAL 9005
33060151	7.5 - 20	10/281/335	B3	+143	155	6500	25		schwarz RAL 9005
33060154	7.5 - 20	10/281/335	B3	+153	165	6500	25		schwarz RAL 9005
10000963	8.0 - 20	10/281/335	A3	0		7500	25		schwarz RAL 9011
10000606	8.0 - 20	10/281/335	B3	+120	134	3850	40		schwarz RAL 9005
33060156	8.0 - 20	10/281/335	B3	+153	165	7100	25		schwarz RAL 9005
39920534	7.50 x 22.5	10/281/335	A3	-138		2300	65	VS H	schwarz RAL 9005
33060212	8.25 x 22.5	8/221/275	A3	-159		4300	40	VS H	schwarz RAL 9005
33060210	8.25 x 22.5	10/281/335	A3	-159		4050	65	VS H	
39920546	8.25 x 22.5	10/281/335	A3	-159		4300	40	VS H	schwarz RAL 9005
10000140	20.00 x 22.5 H2	10/281/335	A3	-10		14310	65	VS H	grau RAL 7011
10000988	14 - 25	12/371/425	A3	0		4500	25	VS H	gelb RAL 1018
32013626	19.50 - 25/2.5	24/449/500	Ø 23.5, M20/M22	+75		13250	40		

VS H = Ventilschutz halbrund
 Standardlackierung für alle Felgen ist silber, wenn keine andere Farbe angegeben ist



Industriefelgen in verschiedenen Ausführungen



Forstfelge

EM-Felgen in verschiedenen Ausführungen

344

Schläuche

371

Wulstbänder

372

Dichtringe und Zwischenringe



SCHLÄUCHE



SERVICE-PLUS BY BOHNENKAMP

Erhalten Sie direkten Zugriff
auf unseren Online-Shop





Schläuche

Preise und Bestände finden Sie unter www.bohnenkamp.de/shop

Artikel-Nr.	Größe	für Reifengröße	Ventil- bezeichnung	Ventil- ausführung	Marke	Ver- packungs- einheit
29800002	24 x 1 3/8	24x13/8	AV-Schrader	Gummiventil	Deli	50
29800023	7 x 1 3/4	7x1 3/4	DIN 7768 90/35	Winkelventil	Kenda	100
29800021	16 x 2.125	16x2.125	AV-Schrader	Gummiventil	Deli	100
29800027	2.50 - 3	2.50-3 210x65 8x2.5	DIN 7777 90/90	Winkelventil	Kenda	170
29800028	2.50 - 3	2.50-3 210x65 8x2.5	DIN 7768 90/20	Winkelventil	Diverse	50
29800029	2.50 - 3	2.50-3 210x65 8x2.5	TR 87	Winkelventil	Kenda	170
29800005	200X50	200x50 8x2	DIN 7768 60/20	Winkelventil	Deli	100
29800003	200X50	200x50 8x2	DIN 7768 90/20	Winkelventil	Deli	100
29800004	200X50	200x50 8x2	DIN 7777 90/90	Winkelventil	Deli	100
29800006	200X50	200x50 8x2	AV-Schrader	Gummiventil	Deli	100
29800039	2.50 - 4	2.50-4 2.80-4 8x3.00-4	DIN 7768 90/20	Winkelventil	Deli	50
29800033	2.50 - 4	2.50-4 2.80-4 8x3.00-4	DIN 7777 90/90	Winkelventil	Deli	50
29800035	3.00 - 4	3.00-4 10x3 260x85	TR 13	Gummiventil	Deli	50
29800040	3.00 - 4	3.00-4 10x3 260x85	DIN 7768 60/20	Winkelventil	Deli	50
29800034	3.00 - 4	3.00-4 10x3 260x85	DIN 7768 90/20	Winkelventil	Deli	50
29800041	3.00 - 4	3.00-4 10x3 260x85	DIN 7777 90/90	Winkelventil	Deli	50
29800031	3.50 - 4	3.50-4 4.00-4 4.10-4	TR 13	Gummiventil	Deli	50
29800030	3.50 - 4	3.50-4 4.00-4 4.10-4	TR 87	Winkelventil	Deli	50
29800038	9x3.50 - 4	9x3.50-4	DIN 7777 90/90	Winkelventil	Deli	50
29800037	11x4.00 - 4	11x4.00-4	TR 13	Gummiventil	Deli	50
29800036	11x4.00 - 4	11x4.00-4	DIN 7777 90/90	Winkelventil	Deli	50
29800579	11 x 7 - 4	11x7.00-4	TR 87	Winkelventil	Deli	25
29800044	3.50 - 5	3.50-5 3.00-5 4.00-5 4.10-5	DIN 7777 90/90	Winkelventil	Deli	50
29800049	10x4.50 - 5	10x4.50-5	TR 87	Winkelventil	Kenda	50
29800046	11x4.00 - 5	11x4.00-5	TR 13	Gummiventil	Deli	50
29800045	11x4.00 - 5	11x4.00-5	DIN 7777 90/90	Winkelventil	Deli	50
29800540	10X2 10X2.125	10X2 10X2.125 2.00-6 260/165-60	AV-Schrader	Gummiventil	Deli	100
29800541	10X2 10X2.125	10X2 10X2.125 2.00-6 260/165-60	DIN 7768 90/90	Winkelventil	Deli	100
29800064	2.50 - 6	2.50-6 3.00-6	TR 13	Gummiventil	Deli	50
29800062	2.50 - 6	2.50-6 3.00-6	TR 87	Winkelventil	Deli	50
29800053	3.50 - 6	3.50-6 4.00-6 4.10-6	TR 13	Gummiventil	Deli	50
29800054	3.50 - 6	3.50-6 4.00-6 4.10-6	TR 87	Winkelventil	Deli	50



Ventil AV-Schrader



Ventil DIN 7768
60/20



Ventil DIN 7768
90/20



Ventil DIN 7768
90/35

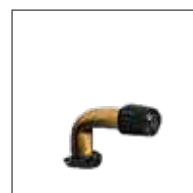

Ventil DIN 7777
90/90



Ventil TR 13

Artikel-Nr.	Größe	für Reifengröße	Ventil-bezeichnung	Ventil-ausführung	Marke	Verpackungseinheit
26810045	3.50/4.00 - 6	4.00-6 3.50-6	10 SC 29	Winkelventil	Kleber *	1
29800581	5.30/4.50 - 6	5.30/4.50-6	TR 13	Gummiventil	Deli	50
29800582	5.30/4.50 - 6	5.30/4.50-6	TR 87	Winkelventil	Deli	50
29800580	6 - 6	6-6 6.00-6	TR 87	Winkelventil	Deli	50
29800061	8.00 - 6	8.00-6	JS 87	Winkelventil	Deli	20
29800583	13x5.00 - 6	13x6.00-6 140-6 145/70-6	TR 13	Gummiventil	Deli	25
29800055	13x5.00 - 6	13x5.00-6 13x6.00-6 145/70-6	TR 13	Gummiventil	Nexen	50
29800584	13x5.00 - 6	13x6.00-6 140-6 145/70-6	TR 87	Winkelventil	Deli	25
29800060	13x5.00 - 6	13x5.00-6 13x6.00-6 145/70-6	TR 87	Winkelventil	Nexen	50
29800058	13x6.50 - 6	13x6.50-6	TR 13	Gummiventil	Nexen	50
29800065	13x6.50 - 6	13x6.50-6	TR 87	Winkelventil	Nexen	50
29800585	15x6.00 - 6	15x5.50-6 15x6.00-6	TR 13	Gummiventil	Deli	25
29800052	15x6.00 - 6	15x5.50-6 15x6.00-6 140-6	TR 13	Gummiventil	Nexen	40
29800057	15x6.00 - 6	15x5.50-6 15x6.00-6 140-6	TR 87	Winkelventil	Nexen	40
29800586	15x6.00 - 6	15x5.50-6 15x6.00-6	TR 87	Winkelventil	Deli	25
29800578	220/50 - 6	220/50-6	TR 13	Gummiventil	Deli	25
29800016	90/65 - 6.5	90/65-6.5 110/50-6.5	TR 87	Winkelventil	Diverse	1
29800069	3.50 - 7	3.50-7 4.00-7	TR 13	Gummiventil	Diverse	50
29800070	3.50 - 7	3.50-7 4.00-7	TR 87	Winkelventil	Diverse	50
29800067	16x8.00 - 7	16x8.00-7	TR 13	Gummiventil	Kenda	25
29800542	12 1/2 X 2 1/4	12 1/2x1.75 12 1/2x1.90 12 1/2 x 2 1/4 2.25-8	DIN 7768 90/90	Winkelventil	Deli	100
29800001	12 1/2 X 2 1/4	12 1/2x1.75 12 1/2x1.90 12 1/2 x 2 1/4 2.25-8	AV-Schrader	Gummiventil	Deli	100
29800012	12 1/2 X 2 1/4	12 1/2x1.75 12 1/2x1.90 12 1/2 x 2 1/4 2.25-8	TR 1	Fahrradventil Metall	Deli	100
29800080	2.25/2.50 - 8	2.25-8 2.50-8	TR 13	Gummiventil	Deli	50
29800094	2.25/2.50 - 8	2.25-8 2.50-8	DIN 7768 90/90	Winkelventil	Deli	50
29800095	3.00/3.50 - 8	3.00-8 3.50-8	TR 13	Gummiventil	Deli	50
29800096	3.00/3.50 - 8	3.00-8 3.50-8	TR 87	Winkelventil	Deli	50
29800072	3.50/4.00 - 8	3.50-8 4.00-8	TR 13	Gummiventil	Deli	50
29800075	3.50 - 8	3.50-8 4.00-8	TR 87	Winkelventil	Deli	50
26810100	4.00 - 8	4.00-8 400x100	TR 13	Gummiventil	Dong Ah	45
26810102	4.00 - 8	4.00-8 400x100 16x4	R 741	Winkelventil	Kleber *	1
29800076	5.00 - 8	5.00-8 5.70-8	TR 13	Gummiventil	Nexen	35
29800078	5.00 - 8	5.00-8 5.70-8	JS 2	Winkelventil	Nexen	35

* = Premium



Ventil JS 2



Ventil JS 87



Ventil TR 1



Ventil TR 87



Ventil R 741



Ventil 10 SC 29



Schläuche

Preise und Bestände finden Sie unter www.bohnenkamp.de/shop

Artikel-Nr.	Größe	für Reifengröße	Ventil- bezeichnung	Ventil- ausführung	Marke	Ver- packungs- einheit
29800089	5.00 - 8	5.00-8 5.70-8	V3-02-7	Winkelventil	Nexen	40
29800099	5.00 - 8	5.00-8	TR 87	Winkelventil	Nexen	35
26810115	5.00 - 8	5.00-8	JS 2	Winkelventil	Dong Ah	35
26810110	5.00 - 8	5.00-8	TR 13	Gummiventil	Dong Ah	40
29800098	5.00/5.70 - 8	5.00-8 5.70-8	TR 13	Gummiventil	Deli	25
29800097	5.00/5.70 - 8	5.00-8 5.70-8	JS 2	Winkelventil	Deli	25
29800024	15x4 1/2 - 8	15x4 1/2-8	V3-02-2	Winkelventil	Nexen	50
29800073	16x6.50 - 8	16x6.50-8 16x7.50-8 18x6.50-8 190-8	TR 13	Gummiventil	Nexen	35
26810120	16x6.50 - 8	16x6.50-8 190-8	TR 13	Gummiventil	Dong Ah	30
29800554	16x6.50 - 8	16x6.50-8	TR 13	Gummiventil	Deli	35
29800083	16x6.50 - 8	16x6.50-8 16x7.50-8 18x6.50-8 190-8	TR 87	Winkelventil	Nexen	30
29800600	16x6.50/7.50 - 8	16x6.50-8 16x7.50-8 18x6.50-8 190-8	TR 13	Gummiventil	Deli	25
29800601	16x6.50/7.50 - 8	16x6.50-8 16x7.50-8 18x6.50-8 190-8	TR 87	Winkelventil	Deli	25
29800572	16x9.50 - 8	16x9.50-8	TR 13	Gummiventil	Deli	20
29800082	18x7 - 8	18x7-8 180/70-8 18x7.00-8	JS 2	Winkelventil	Nexen	30
29991720	18x7 - 8	18x7-8 180/70-8 18x7.00-8	JS 2	Winkelventil	Dong Ah	30
29800085	18x7 - 8	18x7-8 180/70-8 18x7.00-8	V3-02-7	Winkelventil	Nexen	30
26810130	18x7.00/8.50 - 8	18x7.00-8 18x8.50-8	TR 13	Gummiventil	Dong Ah	20
26810135	18x7.00/8.50 - 8	18x7.00-8 18x8.50-8	TR 15	Gummiventil	Dong Ah	20
29800074	18x8.50 - 8	18x7.00-8 18x7.50-8 18x8.50-8 18x9.50-8 18x11.00-8	TR 13	Gummiventil	Nexen	22
29800555	18x8.50 - 8	18x8.50-8	TR 13	Gummiventil	Nexen	22
29800079	18x8.50 - 8	18x7.00-8 18x7.50-8 18x8.50-8 18x9.50-8 18x11.00-8	TR 87	Winkelventil	Nexen	22
29800610	18x8.50/9.50 - 8	18x7.00-8 18x8.50-8 18x9.50-8 18x11.00-8	TR 13	Gummiventil	Deli	20
29800611	18x8.50/9.50 - 8	18x7.00-8 18x8.50-8 18x9.50-8 18x11.00-8	TR 15	Gummiventil	Deli	20
29800612	18x8.50/9.50 - 8	18x7.00-8 18x8.50-8 18x9.50-8 18x11.00-8	TR 87	Winkelventil	Deli	20
29800077	20x8.00 - 8	20x7.00-8 20x8.00-8 20x10.00-8	TR 13	Gummiventil	Nexen	22
28690185	20x10.00 - 8	20x10.00-8	TR 13	Gummiventil	Dong Ah	20
29800086	22x10.00 - 8	21x11.00-8 21x12.00-8 22x10.00-8 22x11.00-8 22x12.00-8	TR 13	Gummiventil	Nexen	22
29800280	22x10.00 - 8	21x11.00-8 21x12.00-8 22x10.00-8 22x11.00-8 22x12.00-8	TR 6	Metallventil	Nexen	22
29800110	4.00 - 9	4.00-9	TR 13	Gummiventil	Nexen	50
26810151	6.00 - 9	6.00-9	TR 13	Gummiventil	Dong Ah	30
29800091	6.00 - 9	6.00-9 6.90-9	TR 13	Gummiventil	Nexen	30
29800092	6.00 - 9	6.00-9 6.90-9	JS 2	Winkelventil	Nexen	30
29800102	6.00 - 9	6.00-9 6.90-9	TR 15	Gummiventil	Nexen	30



Ventil JS 2



Ventil V3-02-2



Ventil TR 6



Ventil TR 13



Ventil TR 15



Ventil TR 87

Artikel-Nr.	Größe	für Reifengröße	Ventil- bezeichnung	Ventil- ausführung	Marke	Ver- packungs- einheit
29800103	6.00 - 9	6.00-9 6.90-9	V3-02-7	Winkelventil	Nexen	30
26070010	6.00 - 9	6.00-9 21x8-9	JS 2	Winkelventil	Dong Ah	30
29800109	20x10.00 - 9	20x10.00-9 20x11.00-9	TR 13	Gummiventil	Nexen	14
29800101	21x8 - 9	21x8-9 200/75-9	JS 2	Winkelventil	Nexen	30
29800100	25x11.00 - 9	25x11.00-9 25x12.00-9 25x13.50-9	TR 13	Gummiventil	Nexen	14
29800121	2.50 - 10	2.50-10 2.75-10 80/90-10	TR 13	Gummiventil	Deli	50
29800134	2.50 - 10	2.50-10 2.75-10 80/90-10	TR 87	Winkelventil	Kenda	20
29800123	3.00 - 10	3.00-10 3.50-10 4.00-10	TR 13	Gummiventil	Nexen	50
29800124	3.00 - 10	3.00-10 100/80-10 110/80-10 100/90-10 3.50-10 90/90-10	TR 4	Metallventil	Kenda	20
29800127	3.00 - 10	3.00-10 100/80-10 110/80-10 3.50-10 90/90-10	TR 87	Winkelventil	Kenda	20
29800116	3.00 - 10	3.00-10 3.50-10 4.00-10	TR 87	Winkelventil	Nexen	50
29800126	4.00 - 10	4.00-10 110/90-10 120/70-10 120/90-10 120/70-11 130/70-10 130/70-11 130/90-10	TR 6	Metallventil	Kenda	20
29800125	4.00 - 10	4.00-10 110/90-10 120/70-10 120/90-10 120/70-11 130/70-10 130/70-11 130/90-10	TR 87	Winkelventil	Kenda	20
29800112	4.50 - 10	4.50-10 5.00-10	TR 13	Gummiventil	Nexen	45
29800132	4.50 - 10	4.50-10 5.00-10	TR 87	Winkelventil	Nexen	45
29800113	4.50 - 10	4.50/5.00-10	TR 218 A	Wasserfüllventil	Nexen	45
26070013	5.00 - 10	5.00-10 145/80-10	TR 13	Gummiventil	Dong Ah	40
29800131	6.50 - 10	6.50-10	TR 13	Gummiventil	Nexen	30
29800133	6.50 - 10	6.50-10	V3-02-7	Winkelventil	Nexen	25
26070020	6.50 - 10	6.50-10	JS 2	Winkelventil	Dong Ah	25
29800115	6.50 - 10	6.50-10	JS 2	Winkelventil	Nexen	25
29800119	7.50 - 10	7.50-10	TR 150	Gummiventil	Nexen	20
29800128	7.50 - 10	7.50-10	JS 2	Winkelventil	Nexen	18
28690230	7.50 - 10	7.50-10	JS 2	Winkelventil	Dong Ah	20
29800118	20x8.00 - 10	20x8.00-10 20x10.00-10	TR 13	Gummiventil	Nexen	30
28690255	20x8.00 - 10	20x8.00-10	TR 13	Gummiventil	Dong Ah	25
29800235	21x7.00 - 10	21x7.00-10 21x9.00-10 22x8.00-10 22x9.00-10 22x10.00-10 22x11.00-10 23x8.00-10	TR 6	Metallventil	Nexen	30
29800120	21x7.00 - 10	21x7.00-10 21x9.00-10 22x8.00-10 22x9.00-10 22x10.00-10 22x11.00-10 23x8.00-10	TR 13	Gummiventil	Nexen	30
29800117	23x9 - 10	23x9-10 225/70-10	JS 2	Winkelventil	Nexen	25
29991717	23x9 - 10	23x9-10 225/70-10	JS 2	Winkelventil	Dong Ah	16



Ventil JS 2



Ventil V3-02-7



Ventil TR 4



Ventil TR 13



Ventil TR 87



Ventil TR 218 A



Schläuche

Preise und Bestände finden Sie unter www.bohnenkamp.de/shop

Artikel-Nr.	Größe	für Reifengröße	Ventil-bezeichnung	Ventil-ausführung	Marke	Verpackungs-einheit
26040000	145 R 10	145-10 4.40-10 5.00-10	TR 13	Gummiventil	Dong Ah	40
29800114	145 - 10	145-10 165/70-10	TR 13	Gummiventil	Nexen	45
29800122	145 - 10	145-10 165/70-10	TR 13	Gummiventil	Nexen	14
29800135	23.5x8.00 - 11	23.5x8.00-11 24x9.00-11	TR 13	Gummiventil	Nexen	30
29800158	3.00 - 12	3.00-12 100/80-12 110/100-12 110/90-12 12C/D 3.50-12 80/100-12 90/90-12	TR 4	Metallventil	Kenda	20
29800145	3.00 - 12	3.00-12 3.50-12	TR 13	Gummiventil	Deli	50
29800154	3.00 - 12	3.00-12 3.50-12	TR 87	Winkelventil	Kenda	50
29800163	3.50 - 12	3.50-12 120/70-12 120/80-12 130/80-12 135/70-12 140/60-12 140/70-12	TR 6	Metallventil	Kenda	20
29800159	4.00 - 12	4.00-12 4.50-12	TR 13	Gummiventil	Nexen	40
26040025	125 R 12	125R12 145/70R12	TR 13	Gummiventil	Dong Ah	40
29800143	125/135 - 12	125-12 135-12 135/70-12 145/70-12	TR 13	Gummiventil	Nexen	40
29800155	125/135 - 12	125-12 135-12 135/70-12 145/70-12	TR 13	Gummiventil	Nexen	14
29800169	5.00 - 12	5.00-12	TR 13	Gummiventil	Nexen	40
26040010	135/145 R 12	135R12 145R12	TR 13	Gummiventil	Dong Ah	40
29800142	145/155 - 12	145-12 155-12 155/70-12 165/70-12	TR 13	Gummiventil	Nexen	40
29800531	145/155 - 12	145-12 155-12 155/70-12 165/70-12	TR 13	Gummiventil	Nexen	14
29800139	6.00 - 12	6.00-12 6-12	TR 13	Gummiventil	Nexen	35
26010011	6.00 - 12	6.00-12	TR 15	Gummiventil	Dong Ah	30
29800160	6.00 - 12	6.00-12 6-12	TR 218 A	Wasserfüllventil	Nexen	35
26040020	155 R 12	155R12 6.5/80-12	TR 13	Gummiventil	Dong Ah	33
26010020	7.00 - 12	7.00-12 8.00-12	TR 13	Gummiventil	Dong Ah	23
29800150	7.00 - 12	7.00-12 8.00-12	TR 13	Gummiventil	Nexen	25
26010010	7.00 - 12	7.00-12 8.00-12	TR 15	Gummiventil	Dong Ah	23
26010012	7.00 - 12	7.00-12 8.00-12	TR 15	Gummiventil	Kleber *	1
29800147	7.00 - 12	7.00-12 8.00-12	TR 15	Gummiventil	Nexen	25
26070030	7.00 - 12	7.00-12 8.00-12	V3-02-7	Winkelventil	Dong Ah	20
29800148	7.00 - 12	7.00-12	V3-02-7	Winkelventil	Nexen	22
29800137	7.00 - 12	7.00-12	JS 2	Winkelventil	Nexen	22
29800166	10.00 - 12	10.00-12	TR 13	Gummiventil	Nexen	16
26010031	10.0/80 - 12	8.50-12 10.0/80-12 11.0/65-12	TR 13	Gummiventil	Dong Ah	15
26010030	10.0/80 - 12	8.50-12 10.0/80-12 11.0/65-12	TR 15	Gummiventil	Dong Ah	15
29800157	10.0/80 - 12	10.0/80-12	TR 15	Gummiventil	Nexen	16

* = Premium



Ventil TR 4



Ventil TR 6



Ventil TR 15



Ventil TR 87



Ventil TR 218 A



Ventil V3-02-7

Artikel-Nr.	Größe	für Reifengröße	Ventilbezeichnung	Ventilausführung	Marke	Verpackungseinheit
26010003	23x8.50 - 12	23x8.50-12 10.50-12	TR 13	Gummiventil	Dong Ah	20
29800140	23x8.50 - 12	23x8.50-12 23x9.50-12 23x10.00-12 23x10.50-12 24x8.50-12 24x10.50-12	TR 13	Gummiventil	Nexen	20
29800146	23x10 - 12	23x10-12	TR 78 A	Winkelventil	Nexen	20
29800141	24x12.00 - 12	24x12.00-12 24x13.00-12	TR 13	Gummiventil	Nexen	15
29800156	25x8.00 - 12	25x8.00-12 25x10.00-12	TR 6	Metallventil	Nexen	20
29800149	25x8.00 - 12	25x8.00-12 25x10.00-12	TR 13	Gummiventil	Nexen	20
26010005	26x12.00 - 12	26x12.00-12	TR 13	Gummiventil	Dong Ah	15
29800138	26x12.00 - 12	26x12.00-12 26x14.00-12 26.5x14.00-12	TR 13	Gummiventil	Nexen	15
29800144	26x12.00 - 12	26x12.00-12 26x14.00-12 26.5x14.00-12	TR 15	Gummiventil	Nexen	15
26010006	26x12.00 - 12	26x12.00-12	TR 218 A	Wasserfüllventil	Dong Ah	15
29800162	26x12.00 - 12	26x12.00-12 26x14.00-12 26.5x14.00-12	TR 218 A	Wasserfüllventil	Nexen	15
29800151	27x8.50 - 12	27x8.50-12 27x9.50-12 27x10.00-12 27x10.50-12	TR 13	Gummiventil	Nexen	16
29991718	27x10 - 12	27x10-12	JS 2	Winkelventil	Dong Ah	15
29800153	27x10 - 12	27x9.50-12 27x10-12 250/75-12 27x10.00-12 27x10.50-12	JS 2	Winkelventil	Nexen	16
29800164	27x10 - 12	27x9.50-12 27x10-12 250/75-12 27x10.00-12 27x10.50-12	TR 78 A	Winkelventil	Nexen	16
26010040	9.00 - 13	9.00-13	TR 15	Gummiventil	Dong Ah	16
29800177	9.00 - 13	9.00-13	TR 15	Gummiventil	Nexen	13
29800026	21x4	21x4	V6-02-1	Winkelventil	Kabat	35
29800009	23x5	23x5 25x6 5.00-13	V3-02-19	Winkelventil	Nexen	35
26810028	23x5	23x5	V3-02-8	Winkelventil	Dong Ah	14
26040040	135/145 R 13	135R13 145R13 155/70R13	TR 13	Gummiventil	Dong Ah	38
29800171	135/145 - 13	135-13 145-13 145/70-13 155/70-13	TR 13	Gummiventil	Nexen	40
29800173	135/145 - 13	135-13 145-13 145/70-13 155/70-13	TR 13	Gummiventil	Nexen	14
26040050	155/165 R 13	155R13 165R13 6.70-13 175/70R13	TR 13	Gummiventil	Dong Ah	30
29800172	155/165 - 13	155-13 165-13 165/70-13 175/70-13	TR 13	Gummiventil	Nexen	14
29800170	155/165 - 13	155-13 165-13 165/70-13 175/70-13	TR 13	Gummiventil	Nexen	35
26040060	175/185 R 13	175R13 185R13 195/70R13	TR 13	Gummiventil	Dong Ah	28
29800175	175/185 - 13	175-13 185-13 185/70-13 195/70-13	TR 13	Gummiventil	Nexen	30
29800174	175/185 - 13	175-13 185-13 185/70-13 195/70-13	TR 13	Gummiventil	Nexen	14
29800176	185/60 - 13	185/60-13 195/60-13 205/60-13 215/60-13	TR 13	Gummiventil	Nexen	30
29800191	2.50 - 14	2.50-14 14C/D 2.75-14 3.00-14 60/100-14 80/80-14	TR 4	Metallventil	Kenda	20
29800186	3.50 - 14	3.50-14 110/80-14 4.10-14 5.40-14 80/100-14 90/100-14	TR 6	Metallventil	Kenda	20
29800180	25x8.50 - 14	25x8.50-14	TR 13	Gummiventil	Nexen	22



Ventil JS 2



Ventil TR 13



Ventil TR 78 A



Ventil V3-02-8



Ventil V3-02-19



Ventil V6-02-1



Schläuche

Preise und Bestände finden Sie unter www.bohnenkamp.de/shop

Artikel-Nr.	Größe	für Reifengröße	Ventil- ...bezeichnung	Ventil- ausführung	Marke	Ver- packungs- einheit
29800189	27x8.50 - 14	27x8.50-14	TR 13	Gummiventil	Nexen	22
26040070	135/145 R 14	135R15 145R14 4.50/5.00-14	TR 13	Gummiventil	Dong Ah	35
29800187	135/145 - 14	135-14 145-14 145/70-14 155/70-14	TR 13	Gummiventil	Nexen	35
26040080	155/165 R 14	155R14 165R14 6-14 175/70R14	TR 13	Gummiventil	Dong Ah	30
29800178	155/165 - 14	155-14 165-14 165/70-14 175/70-14	TR 13	Gummiventil	Nexen	30
29800188	155/165 - 14	155-14 165-14 165/70-14 175/70-14	TR 13	Gummiventil	Nexen	14
26040090	175/185 R 14	175R14 185R14 195/70R14 7-14	TR 13	Gummiventil	Dong Ah	25
29800179	175/185 - 14	175-14 185-14 185/70-14 195/70-14	TR 13	Gummiventil	Nexen	30
29800181	175/185 - 14	175-14 185-14 185/70-14 195/70-14	TR 13	Gummiventil	Nexen	14
29800183	185/60 - 14	185/60-14 195/60-14 205/60-14	TR 13	Gummiventil	Nexen	25
26040100	195/205 R 14	195R14 205R14 215/70R14 9.5L-14	TR 13	Gummiventil	Dong Ah	25
29800184	195/205 - 14	195-14 205-14 205/70-14 215/70-14	TR 13	Gummiventil	Nexen	22
29800190	195/205 - 14	195-14 205-14 205/70-14 215/70-14	TR 13	Gummiventil	Nexen	14
29800192	215/225 - 14	215-14 225-14 225/70-14 235/70-14	TR 13	Gummiventil	Nexen	20
29800180	25x8.50 - 14	25x8.50-14	TR 13	Gummiventil	Nexen	22
29800182	245/60 - 14	245/60-14 255/60-14 265/60-14 275/60-4	TR 13	Gummiventil	Nexen	18
26010050	200/60 - 14.5	200/60-14.5	TR 15	Gummiventil	Dong Ah	25
29800194	200/60 - 14.5	200/60-14.5 24x8.00-14.5	TR 15	Gummiventil	Nexen	30
29800613	30 x 11.50 - 14.5	30x11.50-14.5	V3-02-5	Winkelventil	Nexen	16
26040145	125 R 15	125R15	TR 13	Gummiventil	Dong Ah	35
29800211	125 - 15	125-15 4.00-15 4.50-15	TR 13	Gummiventil	Nexen	40
26040105	135/145 R 15	135R15 145R15	TR 13	Gummiventil	Dong Ah	30
29800201	135/145 - 15	135-15 145-15 145/70-15 155/70-15	TR 13	Gummiventil	Nexen	35
29800220	135/145 - 15	135-15 145-15 145/70-15 155/70-15	TR 13	Gummiventil	Nexen	14
29800237	140/80 - 15	130/90-15 130/90-16 140/80-15 140/80-16 140/90-15 140/90-16 15/16F 150/80-15 150/80-16 150/90-16 160/70-15 160/70-16 160/80-15 160/80-16 MT90-16	34 G	Metallventil	Heidenau	1
29800556	4.50 - 15	4.50-15 5.00-15	TR 15	Gummiventil	Nexen	35
26020010	4.00/5.00 - 15	4.00/5.00-15	TR 15	Gummiventil	Dong Ah	35
29800223	5.00 - 15	5.00-15 5.50-15	JS 2	Winkelventil	Nexen	30
29800227	6.00 - 15	6.00-15 6.50-15	JS 2	Winkelventil	Nexen	25
26040110	155/165 R 15	155R15 165R15 6.50-15	TR 13	Gummiventil	Dong Ah	30
29800195	155/165 - 15	155-15 165-15 165/70-15 175/70-15	TR 13	Gummiventil	Nexen	30



Ventil 34 G



Ventil V3-02-5



Ventil TR 13



Ventil TR 75 A



Ventil TR 77 A



Ventil TR 177 A

Artikel-Nr.	Größe	für Reifengröße	Ventil- bezeichnung	Ventil- ausführung	Marke	Ver- packungs- einheit
29800215	155/165 - 15	155-15 165-15 165/70-15 175/70-15	TR 13	Gummiventil	Nexen	14
29800238	170/80 - 15	170/70-15 170/70-16 170/80-15 15G 170/80-16 180/60-15 180/70-15 180/70-16 200/60-15 200/70-15 200/70-16 5.50-15	34 G	Metallventil	Heidenau	1
29800221	6.50/80 - 15	6.5/80-15	TR 218 A	Wasserfüllventil	Nexen	30
29800219	6.70 - 15	6.70-15 7.00-15 7.50-15 7.60-15	TR 13	Gummiventil	Nexen	22
29800210	6.70 - 15	6.70-15 7.00-15 7.50-15 7.60-15	TR 15	Gummiventil	Nexen	22
26020020	6.70/7.50 - 15	6.70-15 7.50-15 6.5/80-15 7.5-15 7.60-15 9.5-15	TR 15	Gummiventil	Dong Ah	22
26040120	175/185 R 15	175R15 185R15	TR 13	Gummiventil	Dong Ah	25
29800196	175/185/195 - 15	175-15 185-15 185/65-15 185/70-15 195-15 195/65-15	TR 13	Gummiventil	Nexen	22
29800205	175/185/195 - 15	175-15 185-15 185/65-15 185/70-15 195-15 195/65-15	TR 13	Gummiventil	Nexen	14
29800206	185/60 - 15	185/60-15 195/60-15 205/60-15	TR 13	Gummiventil	Nexen	20
26040130	195/205 R 15	195R15 205R15 215/225/75-15 19x400 8.0/7.5-15	TR 13	Gummiventil	Dong Ah	22
29800200	195/205 - 15	195-15 205-15 205/70-15 215/65-15 215/70-15 225/70-15	TR 13	Gummiventil	Nexen	20
29800198	7.00 - 15	7.00-15 7.50-15 205/70-15	V3-02-7	Winkelventil	Nexen	16
26060010	7.00 R 15	7.00R15 27x7.75-15	TR 75 A	Winkelventil	Dong Ah	16
29800213	7.00 - 15	7.00-15 7.50-15 205/70-15	TR 75 A	Winkelventil	Nexen	16
26060020	7.50 R 15	7.50R15	V3-04-2	Winkelventil	Dong Ah	16
29800571	7.5L - 15	7.5-15 28x9.00-15	TR 15	Gummiventil	Nexen	20
29800224	215/60 - 15	215/60-15 225/60-15	TR 13	Gummiventil	Nexen	18
26040140	215/225 R 15	215R15 225R15 215/65R15	TR 13	Gummiventil	Dong Ah	20
29800209	215/225 - 15	215-15 225-15 225/70-15 235/70-15 235/70-15 235/75-15 245/70-15	TR 13	Gummiventil	Nexen	16
29800197	8.15 - 15	8.15-15 8.25-15 28x9-15	TR 177 A	Winkelventil	Nexen	16
29800199	8.15 - 15	8.15-15 8.25-15 28x9-15	V3-06-1	Winkelventil	Nexen	12
29800232	8.15 - 15	8.15-15 8.25-15 28x9-15	V3-04-7	Winkelventil	Nexen	16
29800239	8.15 - 15	8.15-15 8.25-15 28x9-15	V3-04-5	Winkelventil	Nexen	16
26020025	8.15/8.25 - 15	8.15-15 8.25-15 28x9-15	TR 77 A	Winkelventil	Dong Ah	16
26020027	8.15/8.25 - 15	8.15-15 8.25-15 28x9-15	TR 75 A	Winkelventil	Dong Ah	16
26060030	8.25 R 15	8.25R15	V3-04-2	Winkelventil	Dong Ah	14
29800204	10.00 - 15	10.00-15	V3-04-5	Winkelventil	Nexen	12



Ventil TR 218 A



Ventil V3-02-7



Ventil V3-04-2



Ventil V3-04-5



Ventil V3-04-7



Ventil V3-06-1



Schläuche

Preise und Bestände finden Sie unter www.bohnenkamp.de/shop

Artikel-Nr.	Größe	für Reifengröße	Ventil- bezeichnung	Ventil- ausführung	Marke	Ver- packungs- einheit
26060060	10.00 R 15	10.00R15	V3-04-5	Winkelventil	Dong Ah	10
26010060	10.0/11.5 - 15	10.0/11.5-15 29x12.50-15	TR 218 A	Wasserfüllventil	Dong Ah	13
29800218	245/60 - 15	225/70-15 245/60-15 255/60-15 265/60-15 275/60-15	TR 13	Gummiventil	Nexen	14
28690360	250 - 15	250-15	TR 75 A	Winkelventil	Dong Ah	15
29800212	250 - 15	250-15 300-15	TR 75 A	Winkelventil	Nexen	14
29800207	250 - 15	250-15 300-15	TR 78 A	Winkelventil	Nexen	14
29800614	250 - 15	250-15 300-15	V3-02-5	Winkelventil	Nexen	14
29800229	265/70 - 15	265/70-15 265/75-15	TR 13	Gummiventil	Nexen	14
28690361	300 - 15	300-15 315/70-15	TR 75 A	Winkelventil	Dong Ah	12
29800203	27x8.50 - 15	27x8.50-15 28x9.00-15	TR 13	Gummiventil	Nexen	20
26010054	27x8.50 - 15	27x8.50-15 27x10-15.3	TR 15	Gummiventil	Dong Ah	20
29899006	28x12.50 - 15	29x12.50-15	TR 75 A	Winkelventil	Nexen	12
29800217	29x12.50 - 15	29x12.50-15	TR 13	Gummiventil	Nexen	12
28690392	29x12.50 - 15	29x12.50-15	TR 15	Gummiventil	Dong Ah	14
29800216	29x12.50 - 15	29x12.50-15	TR 15	Gummiventil	Nexen	12
29800222	30x9.50 - 15	30x9.50-15 9-15	TR 13	Gummiventil	Nexen	12
29800208	31x10.50 - 15	31x10.50-15 10-15 10.5-15 11-15	TR 13	Gummiventil	Nexen	14
26010056	31x15.50 - 15	31x15.50-15	TR 15	Gummiventil	Dong Ah	12
26010059	31x15.50 - 15	31x15.50-15	TR 218 A	Wasserfüllventil	Dong Ah	10
29800236	31x15.50 - 15	31x15.50-15 12-15 33x12.50-15 33x15.50-15	TR 218 A	Wasserfüllventil	Nexen	12
29800228	33x9.50 - 15	33x9.50-15 33x10.50-15 33x11.50-15	TR 13	Gummiventil	Nexen	12
29800214	33x12.50 - 15	33x12.50-15 12-15 31x15.50-15 33x15.50-15	TR 13	Gummiventil	Nexen	12
29800202	33x12.50 - 15	33x12.50-15 12-15 31x15.50-15 33x15.50-15	TR 15	Gummiventil	Nexen	12
29800243	10/11 - 15.3	10/11-15.3 10.0/75-15.3 11.5/80-15.3	TR 15	Gummiventil	Nexen	14
29800246	10/11 - 15.3	10/11-15.3 10.0/75-15.3 11.5/80-15.3	TR 218 A	Wasserfüllventil	Nexen	14
20800200	10.0/75 - 15.3	10.0/75-15.3 260/70-15.3	TR 15	Gummiventil	BK Tube Masterline *	4
26010080	10.0/75 - 15.3	10.0/75-15.3 260/70-15.3 12.5L-15	TR 15	Gummiventil	Dong Ah	14
26010093	10.0/75 - 15.3	11.5/80-15.3 12.5/80-15.3	TR 15	Gummiventil	Kleber *	1
29800241	10.0/75 - 15.3	10.0/75-15.3	TR 15	Gummiventil	Nexen	14
29800247	10.0/75 - 15.3	10.0/75-15.3	V3-02-7	Winkelventil	Nexen	14
29800242	10.0/75 - 15.3	10.0/75-15.3	TR 218 A	Wasserfüllventil	Nexen	14
20800210	11.5/80 - 15.3	11.5/80-15.3 12.5/80-15.3 300/80-15.3	TR 15	Gummiventil	BK Tube Masterline *	4
26010090	11.5/80 - 15.3	11.5/80-15.3 300/80-15.3 11-15	TR 15	Gummiventil	Dong Ah	12

* = Premium



Ventil TR 13



Ventil TR 15



Ventil TR 78 A



Ventil TR 218 A



Ventil V3-02-5



Ventil V3-04-5

Artikel-Nr.	Größe	für Reifengröße	Ventil-bezeichnung	Ventil-ausführung	Marke	Ver-packungs-einheit
29800245	11.5/80 - 15.3	11.5/80-15.3 12.5/80-15.3	TR 15	Gummiventil	Nexen	12
29800244	11.5/80 - 15.3	11.5/80-15.3 12.5/80-15.3	TR 218 A	Wasserfüllventil	Nexen	12
29910095	12.5/80 - 15.3	12.5/80-15.3 255/75-15 320/80-15.3	TR 15	Gummiventil	Dong Ah	12
29800251	280/60 - 15.5	280/60-15.5	TR 15	Gummiventil	Nexen	14
28690520	400/60 - 15.5	400/60-15.5	TR 15	Gummiventil	Dong Ah	8
29800248	400/60 - 15.5	400/60-15.5 350/70-15.5	TR 15	Gummiventil	Nexen	6
29800249	400/60 - 15.5	400/60-15.5 350/70-15.5	TR 218 A	Wasserfüllventil	Nexen	6
27490530	500/55 - 15.5	500/55-15.5 500-60-15.5	TR 15	Gummiventil	Dong Ah	4
29800250	500/55 - 15.5	500/55-15.5 500/60-15.5	TR 15	Gummiventil	Nexen	6
29800275	2.00 - 16	2.00-16 2.25-16	TR 4	Metallventil	Kenda	20
29800279	2.50 - 16	2.50-16 2.75-16 3.00-16	TR 4	Metallventil	Kenda	20
29800269	3.25 - 16	3.25-16 3.50-16 90/100-16 110/90-16 110/80-16	TR 4	Metallventil	Kenda	20
29800285	3.50 - 16	3.50-16 110/80-16 120/90-16 130/70-16 130/80-16 130/90-16 16E 4.00-16 4.60-16	TR 6	Metallventil	Kenda	20
29800274	4.00 - 16	4.00-16 4.50-16 5.00-16	TR 15	Gummiventil	Nexen	35
26020030	4.00/4.50 - 16	4.00-16 4.50-16	TR 15	Gummiventil	Dong Ah	30
26010089	4.50 - 16	4.50-16	TR 13	Gummiventil	Kleber *	1
29800277	5.00 - 16	5.00-16 5.50-16	TR 13	Gummiventil	Nexen	30
26020040	5.00/5.50 - 16	5.00-16 5.50-16	TR 15	Gummiventil	Dong Ah	28
29800253	5.50 - 16	5.50-16 6.00-16 6.50-16	TR 15	Gummiventil	Nexen	30
20800250	5.50/6.00 - 16	5.50-16 6.00-16	TR 15	Gummiventil	BK Tube Masterline *	12
26010094	5.50/6.00 - 16	5.50-16 6.00-16	TR 15	Gummiventil	Kleber *	1
29800255	6.00 - 16	6.00-16 6.50-16	TR 13	Gummiventil	Nexen	22
26020050	6.00 - 16	6.00-16	TR 15	Gummiventil	Dong Ah	25
29800289	6.00 - 16	6.00-16 6.50-16	TR 75 A	Winkelventil	Nexen	22
26010095	6.00 - 16	6.00-16	TR 218 A	Wasserfüllventil	Dong Ah	25
26010086	6.00 - 16	6.00-16 6.50-16	TR 218 A	Wasserfüllventil	Kleber *	1
29800267	6.00 - 16	6.00-16 6.50-16	TR 218 A	Wasserfüllventil	Nexen	22
29800290	6.00 - 16	6.00-16 6.50-16	V3-02-7	Winkelventil	Nexen	22
29800276	175/80 - 16	175/80-16 185/80-16	TR 13	Gummiventil	Nexen	30
26020060	6.50 - 16	6.50-16	TR 15	Gummiventil	Dong Ah	25
20800255	6.50/7.00 - 16	6.50-16 7.00-16	TR 15	Gummiventil	BK Tube Masterline *	4
26010081	6.50/7.00 - 16	6.50-16 7.00-16	TR 15	Gummiventil	Kleber *	1

* = Premium



Ventil TR 4



Ventil TR 6



Ventil TR 15



Ventil TR 75 A



Ventil TR 218 A



Ventil V3-02-7



Schläuche

Preise und Bestände finden Sie unter www.bohnenkamp.de/shop

Artikel-Nr.	Größe	für Reifengröße	Ventil- bezeichnung	Ventil- ausführung	Marke	Ver- packungs- einheit
29800258	195/80 - 16	195/80-16 205/80-16	TR 13	Gummiventil	Nexen	20
26040150	195/205 R 16	195R16 205R16	TR 13	Gummiventil	Dong Ah	20
29800268	195/205 - 16	195-16 205-16	TR 15	Gummiventil	Nexen	20
29800281	205 - 16	205-16	V3-02-7	Winkelventil	Nexen	20
29800259	7.00 - 16	7.00-16 7.50-16 8.75-16.5	TR 13	Gummiventil	Nexen	20
29800256	7.00 - 16	7.00-16 7.50-16 8.75-16.5	TR 15	Gummiventil	Nexen	20
29800272	7.00 - 16	7.00-16 7.50-16 8.75-16.5	V3-04-7	Winkelventil	Nexen	20
29800273	7.00 - 16	7.00-16 7.50-16 8.75-16.5	TR 218 A	Wasserfüllventil	Nexen	20
29800283	7.00 - 16	7.00-16 7.50-16 8.75-16.5	TR 75 A	Winkelventil	Nexen	16
26060040	7.00 R 16	7.00R16 7.00/7.50-16	V3-04-2	Winkelventil	Dong Ah	15
29800257	7.50 - 16	7.50-16 9.50-16.5	TR 13	Gummiventil	Nexen	20
20800260	7.50 - 16	7.50-16 8-16	TR 15	Gummiventil	BK Tube Masterline *	4
26020080	7.50 - 16	7.50-16 8-16 210/95-16 250/80-16	TR 15	Gummiventil	Dong Ah	18
26010082	7.50 - 16	7.50-16	TR 15	Gummiventil	Kleber *	1
26020090	7.50 - 16	7.50-16 8-16 210/95-16 250/80-16	TR 218 A	Wasserfüllventil	Dong Ah	16
26010087	7.50 - 16	7.50-16	TR 218 A	Wasserfüllventil	Kleber *	1
29800286	7.50 - 16	7.50-16 9.50-16.5	V3-04-7	Winkelventil	Nexen	16
26060050	7.50 R 16	7.50R16	V3-04-2	Winkelventil	Dong Ah	15
29800284	215/80 - 16	215/80-16 225/75-16 235/70-16 245/75-16	TR 13	Gummiventil	Nexen	20
29940160	215/225 R 16	215R16 225R16	TR 13	Gummiventil	Dong Ah	18
29800282	215/225 - 16	215-16 225-16	TR 15	Gummiventil	Nexen	18
26060070	8.25 R 16	8.25R16	V3-04-2	Winkelventil	Dong Ah	12
29800270	8.25 R 16	8.25R16	V3-04-5	Winkelventil	Nexen	12
29800263	235/80 - 16	235/80-16 235/85-16	TR 13	Gummiventil	Nexen	18
29800288	245/70 - 16	245/70-16 255/70-16	TR 13	Gummiventil	Nexen	12
20800265	9.00 - 16	9.00-16	TR 15	Gummiventil	BK Tube Masterline *	4
29995003	9.00 - 16	9.00-16 9.5-16 9.0/75-16	TR 15	Gummiventil	Dong Ah	14
29800260	9.00 - 16	9.00-16	TR 15	Gummiventil	Nexen	12
29800278	9.00 - 16	9.00-16	TR 218 A	Wasserfüllventil	Nexen	12
29800266	9.00 - 16	9.00-16	V3-06-3	Winkelventil	Nexen	10
26010088	260/70 - 16	260/70-16 280/70-16 11LR-16	TR 218 A	Wasserfüllventil	Kleber *	1
29800265	265/70 - 16	265/70-16 265/75-16 275/70-16	TR 13	Gummiventil	Nexen	14
26020113	10.00 - 16	10.00-16	TR 15	Gummiventil	Dong Ah	10
29800261	10.00 - 16	10.00-16 11.00-16 13.6-16 315/80-16	TR 15	Gummiventil	Nexen	12

* = Premium



Ventil TR 13



Ventil TR 15



Ventil TR 75 A



Ventil TR 218 A



Ventil V3-04-2



Ventil V3-04-5

Artikel-Nr.	Größe	für Reifengröße	Ventil- bezeichnung	Ventil- ausführung	Marke	Ver- packungs- einheit
26020110	10.00 - 16	10.00-16	TR 218 A	Wasserfüllventil	Dong Ah	10
26010083	10.00 - 16	10.00-16 11.00-16 12-16 13.6-16	TR 218 A	Wasserfüllventil	Kleber *	1
29800557	10.00 - 16	10.00-16 11.00-16 13.6-16 315/80-16	TR 218 A	Wasserfüllventil	Nexen	12
20800270	10.00/11.00 - 16	10.00-16 11.00-16 13.6-16	TR 15	Gummiventil	BK Tube Masterline *	3
29800287	280/85 - 16	280/85-16	TR 13	Gummiventil	Nexen	12
26030010	320/65 R 16	320/65R16	TR 218 A	Wasserfüllventil	Dong Ah	6
26020121	11.00 - 16	11.00-16 12-16 13.6-16	TR 15	Gummiventil	Dong Ah	8
26020120	11.00 - 16	11.00-16 12-16 13.6-16	TR 218 A	Wasserfüllventil	Dong Ah	8
29800262	11.00 - 16	11.00-16 10.00-16	V3-02-11	Winkelventil	Nexen	12
26020115	10.5/65 - 16	10.5/65-16	TR 15	Gummiventil	Dong Ah	12
29800264	10.5/65 - 16	10.5/65-16	TR 15	Gummiventil	Nexen	12
26010084	10.5 - 16	10.5-16 270/65-16 275/65-16 320/65-16	TR 218 A	Wasserfüllventil	Kleber *	1
26010125	13.0/55 - 16	13.0/55-16	TR 15	Gummiventil	Dong Ah	8
29800271	13.0/55 - 16	13.0/55-16	TR 15	Gummiventil	Nexen	14
26010100	13.0/75 - 16	13.0/75-16	TR 15	Gummiventil	Dong Ah	8
29800254	13.0/75 - 16	13.0/75-16 14.0/65-16	TR 15	Gummiventil	Nexen	12
26010120	14.0/65 - 16	14.0/65-16	TR 15	Gummiventil	Dong Ah	8
26010105	10 - 16.5	10-16.5 260/70-16.5 265/70-16.5	TR 15	Gummiventil	Dong Ah	14
29800292	10 - 16.5	10-16.5	TR 15	Gummiventil	Nexen	18
26010108	12 - 16.5	12-16.5 300/70-16.5 305/70-16.5	TR 15	Gummiventil	Dong Ah	10
29800293	12 - 16.5	12-16.5	TR 15	Gummiventil	Nexen	12
29800301	2.00 - 17	2.00-17 2.25-17	TR 4	Metallventil	Kenda	20
29800300	2.50 - 17	2.50-17 2.75-17 3.00-17 70/100-17	TR 4	Metallventil	Kenda	20
29800296	4.10 - 17	4.10-17 110/70-17 110/80-17 120/70-17 130/60-17 17E 4.60-17	TR 6	Metallventil	Kenda	20
29800298	4.50 - 17	4.50-17 5.10-17 17F	TR 6	Metallventil	Kenda	20
29800299	8 - 17	8-17 8.5-17.5 215/75-17.5	VS3-21-1	Metallventil	Nexen	20
29800303	235/65 - 17	235/65-17	TR 15	Gummiventil	Nexen	12
29800302	13.5/75 - 17	13.5/75-17	TR 15	Gummiventil	Nexen	8
20800280	15.0/55 - 17	15.0/55-17 380/55-17 425/55-17	TR 15	Gummiventil	BK Tube Masterline *	3
26010130	15.0/55 - 17	15.0/55-17 380/55-17	TR 15	Gummiventil	Dong Ah	7
29800294	15.0/55 - 17	15.0/55-17 380/55-17 425/55-17	TR 15	Gummiventil	Nexen	6
26010135	15.0/55 - 17	15.0/55-17 380/55-17	TR 218 A	Wasserfüllventil	Dong Ah	7

* = Premium



Ventil V3-04-7



Ventil V3-06-3



Ventil TR 4



Ventil TR 6



Ventil V3-02-11



Ventil VS3-21-1



Schläuche

Preise und Bestände finden Sie unter www.bohnenkamp.de/shop

Artikel-Nr.	Größe	für Reifengröße	Ventil- bezeichnung	Ventil- ausführung	Marke	Ver- packungs- einheit
29800558	15.0/55 - 17	15.0/55-17 380/55-17 425/55-17	TR 218 A	Wasserfüllventil	Nexen	6
29010050	19.0/45 - 17	19.0/45-17 500/50-17	TR 15	Gummiventil	Dong Ah	4
29800297	19.0/45 - 17	19.0/45-17	TR 15	Gummiventil	Nexen	6
29800295	500/50 - 17	500/50-17	TR 15	Gummiventil	Nexen	4
26060180	215/75 - 17.5	215/75-17.5 235/75-17.5 9.5-17.5	TR 75 A	Winkelventil	Dong Ah	14
29800304	9 - 17.5	9-17.5 10-17.5	VS3-21-1	Metallventil	Nexen	12
29800306	350/65 - 17.5	350/65-17.5 400/55-17.5	TR 15	Gummiventil	Nexen	6
29800305	350/70 - 17.5	350/70-17.5	TR 218 A	Wasserfüllventil	Nexen	8
29800316	2.75 - 18	2.75-18 18C/D 3.00-18 90/90-18	TR 4	Metallventil	Kenda	20
29800315	3.00 - 18	3.00-18 100/80-18 3.60-18 90/90-18	TR 4	Metallventil	Kenda	20
29800319	3.50 - 18	3.50-18 100/80-18 110/80-18 18D/E 3.25-18 4.10-18	TR 6	Metallventil	Kenda	20
29800317	4.00 - 18	4.00-18 120/80-18 120/90-18 130/80-18 130/90-1 140/80-18 18F 3.25-18 3.50-18 4.10-18 4.25-18 4.50-18 4.60-18	TR 4	Metallventil	Kenda	20
29800314	4.25 - 18	4.00-18 4.25-18 4.50-18	TR 6	Metallventil	Kenda	20
29800312	6.00 - 18	6.00-18 6.50-18	TR 15	Gummiventil	Nexen	16
26020130	7.50 - 18	7.50-18 8.00-18 210/95-18	TR 15	Gummiventil	Dong Ah	14
29800309	7.50 - 18	7.50-18	TR 15	Gummiventil	Nexen	15
26020134	7.50 - 18	7.50-18 8.00-18 210/95-18	TR 15	Gummiventil	Kleber *	1
26020133	7.50 - 18	7.50-18 8.00-18 210/95-18	TR 218 A	Wasserfüllventil	Kleber *	1
26020131	7.50 - 18	7.50-18 8.00-18 210/95-18	TR 75 A	Winkelventil	Dong Ah	14
20800290	7.50/8.00 - 18	7.50-18 8.00-18	TR 15	Gummiventil	BK Tube Masterline *	4
20800293	10.5/80 - 18	10.5/80-18 13.0/65-18 275/80-18 335/65-18	TR 15	Gummiventil	BK Tube Masterline *	4
26010140	10.5/80 - 18	10.5/80-18 250/80-18 10.5-18 280/80-18	TR 15	Gummiventil	Dong Ah	10
29800307	10.5/80 - 18	10.5/80-18 13.0/65-18 275/80-18 335/65-18	TR 15	Gummiventil	Nexen	10
26010145	10.5/80 - 18	10.5/80-18 250/80-18 10.5-18 280/80-18	TR 218 A	Wasserfüllventil	Dong Ah	10
26010163	10.5/80 - 18	10.5/80-18 270/65-18 260/70-18 280/70-18	TR 218 A	Wasserfüllventil	Kleber *	1
29800310	10.5/80 - 18	10.5/80-18 13.0/65-18 275/80-18 335/65-18	TR 218 A	Wasserfüllventil	Nexen	10
26020075	12.0/12.5 - 18	12.0-18 12.5-18 320/65-18 335/80-18 340/65-18 340/80-18	TR 218 A	Wasserfüllventil	Kleber *	1
20800295	12.5/80 - 18	12.5/75-18 12.5/80-18 15.0/70-18 335/80-18	TR 15	Gummiventil	BK Tube Masterline *	3
26010160	12.5/80 - 18	12.5/80-18 12.5-18 12.0/75-18 320/80-18	TR 15	Gummiventil	Dong Ah	8
29800313	12.5/80 - 18	12.5/75-18 12.5/80-18 15.0/70-18 335/80-18	TR 15	Gummiventil	Nexen	8

* = Premium



Ventil TR 4



Ventil TR 6



Ventil TR 75 A



Ventil V3-06-8



Ventil TR 218 A



Ventil VS3-21-1

Artikel-Nr.	Größe	für Reifengröße	Ventil- bezeichnung	Ventil- ausführung	Marke	Ver- packungs- einheit
26010170	12.5/80 - 18	12.5/80-18 12.5-18 12.0/75-18 320/80-18	TR 218 A	Wasserfüllventil	Dong Ah	8
29800308	12.5/80 - 18	12.5/80-18 15.0/70-18 335/80-18	TR 218 A	Wasserfüllventil	Nexen	8
29800320	12.5/80 - 18	12.5/75-18 12.5/80-18 15.0/70-18 335/80-18	V3-06-8	Winkelventil	Nexen	8
26010165	320/65 - 18	12.0-18 340/65-18 12.5-18 315/80-18 320/65-18 335/65-18 335/80-18 340/65-18 340/80-18	TR 15	Gummiventil	Kleber *	1
26030030	340/65 R 18	340/65R18	TR 218 A	Wasserfüllventil	Dong Ah	6
26010173	13.0/65 - 18	13.0/65-18 14.5/80-18 355/60-18 365/70-18	TR 15	Gummiventil	Dong Ah	8
26010180	15.0/70 - 18	15.0/70-18 405/70-18	TR 15	Gummiventil	Dong Ah	6
26010175	15.0/70 - 18	15.0/70-18 405/70-18	TR 218 A	Wasserfüllventil	Dong Ah	5
26010182	15.5/55 - 18	15.5/55-18 385/55-18 405/70-18	TR 15	Gummiventil	Dong Ah	6
29800323	2.00 - 19	2.00-19 2.25-19	TR 4	Metallventil	Kenda	20
29800327	2.50 - 19	2.50-19 19C 2.75-19 70/100-19	TR 4	Metallventil	Kenda	20
29800325	3.00 - 19	3.00-19 3.60-19 19D 90/90-19 100/90-19	TR 4	Metallventil	Kenda	20
29800559	3.50 - 19	3.50-19 110/80-19 110/90-19 120/80-19 130/80-19 19E 3.25-19 4.10-19	TR 4	Metallventil	Kenda	20
26020137	4.00 - 19	4.00-19 4.50-19	TR 13	Gummiventil	Kleber *	1
29800324	4.00 - 19	4.00-19 4.50-19	TR 13	Gummiventil	Nexen	30
29800322	4.00 - 19	4.00-19 4.50-19	TR 15	Gummiventil	Nexen	30
26020135	4.00 - 19	4.00-19	TR 15	Gummiventil	Dong Ah	25
26020140	6.00 - 19	6.00-18 6.00-19	TR 15	Gummiventil	Dong Ah	18
26020142	6.00 - 19	6.00-18 6.00-19	TR 15	Gummiventil	Kleber *	1
29800326	6.00 - 19	6.00-19	TR 15	Gummiventil	Nexen	20
26010185	8.00 - 19	8.00-19	TR 15	Gummiventil	Dong Ah	12
29800329	8 - 19.5	8-19.5 9-19.5 245/70-19.5	VS3-21-1	Metallventil	Nexen	16
29800330	18 - 19.5	18-19.5	TR 15	Gummiventil	Kabat	6
29800355	6.00 - 20	6.00-20 6.50-20	TR 15	Gummiventil	Nexen	15
29800351	6.00 - 20	6.00-20 6.50-20	V3-04-5	Winkelventil	Nexen	15
26020150	6.00/6.50 - 20	6.00-20 6.50-20	TR 15	Gummiventil	Dong Ah	17
26060080	6.50 - 20	6.50-20	V3-04-2	Winkelventil	Dong Ah	14
20800310	6.50/7.50 - 20	6.50-20 7.50-20 280/70-20	TR 15	Gummiventil	BK Tube Masterline *	4
20800300	6.50/7.50 - 20	6.50-20 7.50-20 280/70-20	TR 218 A	Wasserfüllventil	BK Tube Masterline *	4
29800348	7.00 - 20	7.00-20 260/70-20 280/70-20 7.50-20	TR 15	Gummiventil	Nexen	14
29800357	7.00 - 20	7.00-20 7.50-20	V3-06-3	Winkelventil	Nexen	14

* = Premium



Ventil V3-04-2



Ventil TR 13



Ventil TR 15



Ventil V3-06-3



Ventil V3-04-5



Ventil VS3-21-1



Schläuche

Preise und Bestände finden Sie unter www.bohnenkamp.de/shop

Artikel-Nr.	Größe	für Reifengröße	Ventil- bezeichnung	Ventil- ausführung	Marke	Ver- packungs- einheit
29800366	7.00 - 20	7.00-20 260/70-20 280/70-20 7.50-20	TR 177 A	Winkelventil	Nexen	14
26060100	7.00/7.50 R 20	7.00R20 7.50R20	V3-04-2	Winkelventil	Dong Ah	12
26020160	7.50 - 20	7.50-20 8.00-20	TR 15	Gummiventil	Dong Ah	14
26020166	7.50 - 20	7.50-20 8.00-20	TR 15	Gummiventil	Kleber *	1
26020165	7.50 - 20	7.50-20 8.00-20	TR 218 A	Wasserfüllventil	Kleber *	1
29800569	8.0 - 20	8.0-20 9.0-20 9.5/9.0-20 260/80-20 300/70-20	TR 218 A	Wasserfüllventil	Nexen	12
29800576	8.25 - 20	8.25-20	V3-02-5	Winkelventil	Nexen	14
29800334	8.25 - 20	8.25-20	V3-06-3	Winkelventil	Nexen	14
26060110	8.25 R 20	8.25R20 285/70-19.5	V3-04-2	Winkelventil	Dong Ah	10
20800340	8.3 - 20	8.3-20 260/70-20	TR 218 A	Wasserfüllventil	BK Tube Masterline *	4
20800345	9.5 - 20	9.5-20 250/85-20 260/70-20 280/70-20 300/70-20	TR 218 A	Wasserfüllventil	BK Tube Masterline *	4
26020510	9.5 - 20	9.5-20 250/85-20 260/70-20 280/70-20 300/70-20	TR 218 A	Wasserfüllventil	Dong Ah	10
26020513	260/70 - 20	9.5-20 260/70-20 280/70-20	TR 218 A	Wasserfüllventil	Kleber *	1
20800360	9.00 - 20	9.00-20	TR 175 A	Winkelventil	BK Tube Masterline *	3
29800577	9.00 - 20	9.00-20	V3-02-5	Winkelventil	Nexen	8
29800340	9.00 - 20	9.00-20	V3-06-3	Winkelventil	Nexen	8
26060120	9.00 R 20	9.00R20 335/80-20	V3-04-2	Winkelventil	Dong Ah	9
20800365	10.00 - 20	10.00-20	TR 78 A	Winkelventil	BK Tube Masterline *	3
29800331	10.00 - 20	10.00-20	V3-02-10	Winkelventil	Nexen	8
29800332	10.00 - 20	10.00-20	V3-06-8	Winkelventil	Nexen	8
29800336	10.00 - 20	10.00-20	V3-06-16	Winkelventil	Nexen	8
26060130	10.00 R 20	10.00R20	V3-06-8	Winkelventil	Dong Ah	7
26010190	10.5/80 - 20	10.5/80-20 280/85-20	TR 15	Gummiventil	Dong Ah	10
29800346	10.5/80 - 20	10.5/80-20 10.5-20 275/70-20	TR 15	Gummiventil	Nexen	8
26010195	10.5/80 - 20	10.5/80-20 280/85-20	TR 218 A	Wasserfüllventil	Dong Ah	10
29800358	10.5/80 - 20	10.5/80-20 10.5-20 275/70-20	TR 218 A	Wasserfüllventil	Nexen	8
26020514	300/70 - 20	10.5-20 11.2-20 280/70-20 300/70-20 320/70-20	TR 218 A	Wasserfüllventil	Kleber *	1
20800370	11.00 - 20	11.00-20	TR 78 A	Winkelventil	BK Tube Masterline *	2
29800349	11.00 - 20	11.00-20 13/80-20 335/80-20 E20Pilote	V3-04-3	Winkelventil	Nexen	7
29800333	11.00 - 20	11.00-20	V3-02-10	Winkelventil	Nexen	7
29800337	11.00 - 20	11.00-20 13/80-20 335/80-20 E20Pilote	V3-06-8	Winkelventil	Nexen	7
26060140	11.00 R 20	11.00R20 49X17	V3-06-8	Winkelventil	Dong Ah	6
20800350	11.2 - 20	11.2-20 280/85-20 320/70-20	TR 218 A	Wasserfüllventil	BK Tube Masterline *	4
29800364	11.2 - 20	11.2-20 11.2/10-20 12.4/11-20 320/70-20 360/70-20	TR 218 A	Wasserfüllventil	Nexen	8

* = Premium



Ventil TR 177 A



Ventil TR 218 A



Ventil V3-02-5



Ventil V3-02-10



Ventil V3-04-2



Ventil V3-04-3

Artikel-Nr.	Größe	für Reifengröße	Ventil- bezeichnung	Ventil- ausführung	Marke	Ver- packungs- einheit
20800375	12.00 R 20	12.00R20 14.0/70-20 14.0/80-20 365/80-20 F20Pilote	TR 78 A	Winkelventil	BK Tube Masterline *	2
26060150	12.00 R 20	12.00R20 14.0/70-20	V3-06-8	Winkelventil	Dong Ah	5
29800338	12.00 - 20	12.00-20 14.0/70-20 14.0/80-20 365/80-20 F20Pilote	V3-06-8	Winkelventil	Nexen	6
29800362	12.00 - 20	12.00-20 14.0/70-20 14.0/80-20 365/80-20 F20Pilote	V3-04-25	Winkelventil	Nexen	6
20800355	12.4 - 20	12.4-20 320/85-20 360/70-20	TR 218 A	Wasserfüllventil	BK Tube Masterline *	4
26010200	12.5/80 - 20	12.5/80-20 12.4-20 12.5-20 320/85-20 340/80-20	TR 15	Gummiventil	Dong Ah	7
29800343	12.5/80 - 20	12.5/80-20 12.5-20 355/80-20	TR 15	Gummiventil	Nexen	7
26010205	12.5/80 - 20	12.5/80-20 12.4-20 12.5-20 320/85-20 340/80-20	TR 218 A	Wasserfüllventil	Dong Ah	7
29800345	12.5/80 - 20	12.5/80-20 12.5-20 355/80-20	TR 218 A	Wasserfüllventil	Nexen	7
29800368	12.5/80 - 20	12.5/80-20 12.5-20 355/80-20	V3-06-8	Winkelventil	Nexen	7
26020515	375/75 - 20	12.5-20 340/70-20 370/75-20 375/75-20 380/75-20 400/70-20 405/70-20 420/75-20 425/75-20	TR 218 A	Wasserfüllventil	Kleber *	1
26030050	340/65 R 20	340/65R20	TR 218 A	Wasserfüllventil	Dong Ah	5
26060160	14.00 R 20	14.00R20 15.5/80-20 365/85-20	V3-06-8	Winkelventil	Dong Ah	4
29800342	14.00 - 20	14.00-20 15.5/80-20 365/85-20 G20	V3-06-8	Winkelventil	Nexen	4
26010210	14.5/80 - 20	14.5/80-20	TR 15	Gummiventil	Dong Ah	5
29800344	14.5/80 - 20	14.5/80-20 13.6/12-20 14.5-20 365/80-20	TR 15	Gummiventil	Nexen	6
26010215	14.5/80 - 20	14.5/80-20	TR 218 A	Wasserfüllventil	Dong Ah	5
29800347	14.5/80 - 20	14.5/80-20 13.6/12-20 14.5-20 380/70-20	TR 218 A	Wasserfüllventil	Nexen	6
29800352	14.5/80 - 20	14.5/80-20 13.6/12-20 14.5-20 380/70-20	V3-06-8	Winkelventil	Nexen	6
26030060	420/65 R 20	420/65R20	TR 218 A	Wasserfüllventil	Dong Ah	4
29800353	16.00 - 20	16.00-20	V3-06-8	Winkelventil	Nexen	3
26060165	16.00 R 20	16.00R20	V3-06-8	Winkelventil	Dong Ah	3
20800320	16.0/70 - 20	16.0/70-20 400/70-20 405/70-20	TR 15	Gummiventil	BK Tube Masterline *	2
26010220	16.0/70 - 20	16.0/70-20 375/75-20 400/70-20 405/70-20 455/70-20 500/55-20	TR 15	Gummiventil	Dong Ah	5
29800339	16.0/70 - 20	16.0/70-20 13.00-20 405/70-20	TR 15	Gummiventil	Nexen	5
26010225	16.0/70 - 20	16.0/70-20	TR 218 A	Wasserfüllventil	Dong Ah	5
29800341	16.0/70 - 20	16.0/70-20 13.00-20 405/70-20	TR 218 A	Wasserfüllventil	Nexen	5
26060170	16.0/70 - 20	16.0/70-20	V3-04-5	Winkelventil	Dong Ah	5
29800359	16.0/70 - 20	16.0/70-20 13.00-20 405/70-20	V3-04-5	Winkelventil	Nexen	5
29800361	16.0/70 - 20	16.0/70-20	V3-06-8	Winkelventil	Nexen	5
26010250	16.0/70 - 20	20.0/70-20 21.0/80-20 1300X530X533	V3-06-7	Winkelventil	Dong Ah	3
26030040	440/65 R 20	440/65R20	TR 218 A	Wasserfüllventil	Dong Ah	4

* = Premium



Ventil V3-04-5



Ventil V3-04-25



Ventil V3-06-3



Ventil V3-06-7



Ventil V3-06-8



Ventil V3-06-16



Schläuche

Preise und Bestände finden Sie unter www.bohnenkamp.de/shop

Artikel-Nr.	Größe	für Reifengröße	Ventil- bezeichnung	Ventil- ausführung	Marke	Ver- packungs- einheit
29800356	18.0/70 - 20	18.0/70-20 17.0/70-20	TR 218 A	Wasserfüllventil	Nexen	3
29800360	18.0/70 - 20	18.0/70-20 17.0/70-20	V3-04-5	Winkelventil	Nexen	3
29800350	20.0/70 - 20	20.0/70-20 20/70-508	TR 15	Gummiventil	Nexen	3
29800363	20.0/70 - 20	20.0/70-20	V3-04-5	Winkelventil	Nexen	3
26010252	20.0/70 - 508	20.0/70-20 20.0/70-508 21.0/80-20	TR 15	Gummiventil	Dong Ah	3
26010240	20.0/70 - 508	20.0/70-20 20.0/70-508 21.0/80-20	TR 150	Gummiventil	Dong Ah	3
29800370	2.50 - 21	2.50-21 2.25-21 2.75-21 21C 70/100-21 80/80-21 80/90-21	TR 4	Metallventil	Kenda	20
29800369	3.00 - 21	3.00-21 3.25-21 80/100-21 80/90-21 90/80-21 90/90-21	TR 4	Metallventil	Kenda	20
29800371	9.5 - 22	9.5-22 8/8.3-22 260/70-22 300/70-22	TR 218 A	Wasserfüllventil	Nexen	14
29800377	8 - 22.5	8-22.5 9-22.5	V3-02-11	Winkelventil	Nexen	14
26060194	10 R 22.5	10R22.5	VS3-21-1	Metallventil	Dong Ah	6
29800568	11 - 22.5	11-22.5 295/80-22.5	VS3-21-1+	Metallventil	Nexen	8
29800389	12 - 22.5	12-22.5 315/80-22.5	V3-02-11	Winkelventil	Nexen	7
26062000	12 - 22.5	12-22.5	VS3-21-1	Metallventil	Dong Ah	6
29800378	15 - 22.5	15-22.5 385/65-22.5	TR 218 A	Wasserfüllventil	Nexen	5
29800382	15 - 22.5	15-22.5 385/65-22.5	VS3-21-1	Metallventil	Nexen	5
26060190	15 R 22.5	15R22.5 385/65R22.5	VS3-21-1	Metallventil	Dong Ah	4
29800381	18 - 22.5	18-22.5	TR 218 A	Wasserfüllventil	Nexen	3
29910320	400/55 - 22.5	400/55-22.5 400/60-22.5	TR 218 A	Wasserfüllventil	Dong Ah	3
29800615	400/55 - 22.5	400/55-22.5 400/60-22.5	TR 218 A	Wasserfüllventil	Nexen	5
28690540	500/45 - 22.5	500/45-22.5 18-22.5 500/50-22.5	TR 218 A	Wasserfüllventil	Dong Ah	2
20801010	500/60 - 22.5	500/60-22.5 600/50-22.5	TR 218 A	Wasserfüllventil	BK Tube Forestline */**	1
27490550	500/60 - 22.5	500/60-22.5	TR 218 A	Wasserfüllventil	Dong Ah	2
29800375	500/60 - 22.5	500/60-22.5 600/50-22.5	TR 218 A	Wasserfüllventil	Nexen	2
29991742	550/45 - 22.5	550/45-22.5 560/45-22.5	TR 218 A	Wasserfüllventil	Nokian */**	1
22090580	550/60 - 22.5	550/60-22.5 560/45-22.5 560/55-22.5 560/60-22.5	TR 218 A	Wasserfüllventil	Dong Ah	2
27490560	600/50 - 22.5	580/65-22.5 600/50-22.5 600/55-22.5 620/40-22.5 620/55-22.5	TR 218 A	Wasserfüllventil	Dong Ah	2
29991730	600/50 - 22.5	600/50-22.5 600/55-22.5	TR 218 A	Wasserfüllventil	Nokian */**	1
20801020	700/40 - 22.5	700/40-22.5 700/45-22.5 710/40-22.5	TR 218 A	Wasserfüllventil	BK Tube Forestline */**	1
28690552	700/40 - 22.5	700/40-22.5 700/45-22.5 710/40-22.5	TR 218 A	Wasserfüllventil	Dong Ah	2

* = Premium ** = Forst



Ventil TR 4



Ventil TR 15



Ventil TR 150



Ventil TR 218 A



Ventil V3-02-11



Ventil VS3-21-1/VS3-21-1+

Artikel-Nr.	Größe	für Reifengröße	Ventil- bezeichnung	Ventil- ausführung	Marke	Ver- packungs- einheit
29800376	700/40 - 22.5	700/40-22.5 700/45-22.5 710/40-22.5	TR 218 A	Wasserfüllventil	Nexen	2
29991708	700/45 - 22.5	700/45-22.5 710/40-22.5	TR 218 A	Wasserfüllventil	Nokian */**	1
27490685	700/50 - 22.5	700/50-22.5	TR 218 A	Wasserfüllventil	Dong Ah	2
29800390	2.75 - 23	2.75-23 3.00-23	TR 4	Metallventil	Kenda	20
26020520	8.3 - 24	8.3-24 210/90-24 220/85-24	TR 218 A	Wasserfüllventil	Dong Ah	10
26020563	8.3 - 24	8.3-24 210/90-24 9.5-24 250/85-24	TR 218 A	Wasserfüllventil	Kleber *	1
29800394	8.3 - 24	8.3-24 8.3/8-24 9.5/9-24 260/70-24 300/70-24	TR 218 A	Wasserfüllventil	Nexen	10
20800390	8.3/9.5 - 24	8.3-24 9.5-24 250/85-24 300/70-24	TR 218 A	Wasserfüllventil	BK Tube Masterline *	4
26020530	9.5 - 24	9.5/9-24 250/85-24	TR 218 A	Wasserfüllventil	Dong Ah	10
26020540	11.2 - 24	11.2-24 260/80-24 280/85-24 320/70-24 340/80-24 300/80-24	TR 218 A	Wasserfüllventil	Dong Ah	7
29800392	11.2 - 24	11.2-24 11.2/10-24 12.4/-24 280/85-24 320/70-24 320/85-24 360/70-24	TR 218 A	Wasserfüllventil	Nexen	6
20800400	11.2/12.4 - 24	11.2-24 12.4-24 280/85-24 320/70-24	TR 218 A	Wasserfüllventil	BK Tube Masterline *	3
20800420	12.00 - 24	12.00-24	TR 78 A	Winkelventil	BK Tube Masterline *	2
29800398	12.00 - 24	12.00-24	V3-04-5	Winkelventil	Nexen	5
29995005	12.00 - 24	12.00-24	V3-04-5	Winkelventil	Dong Ah	5
26020550	12.4 - 24	12.4-24 320/85-24 360/70-24	TR 218 A	Wasserfüllventil	Dong Ah	6
26020553	12.4 - 24	11.2-24 12.4-24 320/70-24 320/85-24 360/70-24	TR 218 A	Wasserfüllventil	Kleber *	1
29800401	13.00 - 24	13.00-24 13.00-25	TRJ 1175 C	Winkelventil	Nexen	5
20800405	13.6 - 24	13.6-24 340/85-24 380/70-24	TR 218 A	Wasserfüllventil	BK Tube Masterline *	2
26020560	13.6 - 24	13.6-24 340/80-24 340/85-24 380/70-24	TR 218 A	Wasserfüllventil	Dong Ah	5
29991723	13.6 - 24	13.6-24 340/80-24 340/85-24 380/70-24 420/65-24	TR 218 A	Wasserfüllventil	Kleber *	1
29800391	13.6 - 24	14.5-24 13.6-24 13.6/12-24 14.9-24 14.9/13-24 340/85-24 380/70-24 380/85-24 405/70-24 420/70-24	TR 218 A	Wasserfüllventil	Nexen	5
20800425	14.00 - 24/25	14.00-24 14.00-25	TRJ 1175 C	Winkelventil	BK Tube Masterline *	1
29800396	14.00 - 24	14.00-24 14.00-25 15.5-25	TRJ 1175 C	Winkelventil	Nexen	4
29800400	14.00 - 24	14.00-24	V3-04-5	Winkelventil	Nexen	4
26070050	14.00 - 24	14.00-24	TRJ 1175 C	Winkelventil	Dong Ah	4
26020570	14.9 - 24	14.9-24 380/85-24 15.5/80-24 400/80-24 420/70-24	TR 218 A	Wasserfüllventil	Dong Ah	5
29991734	14.9 - 24	14.9-24 16.9/14-24	TR 218 A	Wasserfüllventil	Nokian */**	1
20800410	14.9/16.9 - 24	14.9-24 16.9-24 380/85-24 400/80-24 420/70-24 15.5/80-24	TR 218 A	Wasserfüllventil	BK Tube Masterline *	2

* = Premium ** = Forst



Ventil TR 4



Ventil TR 78 A



Ventil TR 218 A



Ventil V3-04-5



Ventil TRJ 1175C



Schläuche

Preise und Bestände finden Sie unter www.bohnenkamp.de/shop

Artikel-Nr.	Größe	für Reifengröße	Ventil- bezeichnung	Ventil- ausführung	Marke	Ver- packungs- einheit
29800399	15.5/80 - 24	15.5/80-24 16.0/70-24 16.5/85-24 405/70-24	TR 218 A	Wasserfüllventil	Nexen	4
29800395	16.00 - 24	16.00-24 16.00-25 17.5-25	TRJ 1175 C	Winkelventil	Nexen	3
26070080	16.00 - 24	16.00-24 16.00-25	TRJ 1175 C	Winkelventil	Dong Ah	3
26010260	16.0/70 - 24	16.0/70-24 400/70-24 405/70-24	TR 218 A	Wasserfüllventil	Dong Ah	5
26020580	16.9 - 24	16.9-24 420/65-24 420/85-24 440/65-24 445/70-24	TR 218 A	Wasserfüllventil	Dong Ah	5
29800393	16.9 - 24	16.9-24 16.9/14-24 420/85-24 480/70-24 495/70-24 500/70-24	TR 218 A	Wasserfüllventil	Nexen	4
26030080	420/65 R 24	420/65R24	TR 218 A	Wasserfüllventil	Dong Ah	3
26030070	440/65 R 24	440/65R24	TR 218 A	Wasserfüllventil	Dong Ah	3
26020584	440/65 - 24	14.9-24 380/85-24 400/70-24 400/80-24 420/70-24 440/65-24	TR 218 A	Wasserfüllventil	Kleber *	1
26030090	480/65 R 24	480/65R24	TR 218 A	Wasserfüllventil	Dong Ah	3
26030100	540/65 R 24	540/65R24	TR 218 A	Wasserfüllventil	Dong Ah	2
26020585	540/65 - 24	16.9-24 17.5-24 420/85-24 460/70-24 480/70-24 500/70-24	TR 218 A	Wasserfüllventil	Kleber *	1
29800402	18.00 - 24	18.00-24 18.00-25 20.5-25	TRJ 1175 C	Winkelventil	Nexen	2
29995006	20 - 24	20-24	TRJ 1175 C	Winkelventil	Dong Ah	2
29800397	20 - 24	20-24	TRJ 1175 C	Winkelventil	Nexen	2
29991743	650/45 - 24.5	650/45-24.5	TR 218 A	Wasserfüllventil	Nokian */**	1
29991706	710/40 - 24.5	710/40-24.5	TR 218 A	Wasserfüllventil	Nokian */**	1
26070110	15.5 - 25	15.5-25	TRJ 1175 C	Winkelventil	Dong Ah	4
26070120	17.5 - 25	17.5-25	TRJ 1175 C	Winkelventil	Dong Ah	3
26070130	18.00 - 25	18.00-25	TRJ 1175 C	Winkelventil	Dong Ah	2
26070140	20.5 - 25	20.5-25	TRJ 1175 C	Winkelventil	Dong Ah	2
26070150	23.5 - 25	23.5-25	TRJ 1175 C	Winkelventil	Dong Ah	2
29800406	23.5 - 25	23.5-25 26.5-25	TRJ 1175 C	Winkelventil	Nexen	2
26070160	26.5 - 25	26.5-25	TRJ 1175 C	Winkelventil	Dong Ah	1
29800403	29.5 - 25	29.5-25	TRJ 1175 C	Winkelventil	Nexen	1
20800440	13.6 - 26	13.6-26	TR 218 A	Wasserfüllventil	BK Tube Masterline *	2
20800445	14.9 - 26	14.9-26 380/85-26 420/70-26	TR 218 A	Wasserfüllventil	BK Tube Masterline *	2
26020590	14.9 - 26	14.9-26 420/70-26	TR 218 A	Wasserfüllventil	Dong Ah	5
29800409	14.9 - 26	14.9-26 400/70-26 420/70-26	TR 218 A	Wasserfüllventil	Nexen	4
26020600	16.9 - 26	16.9-26 420/85-26 480/70-26	TR 218 A	Wasserfüllventil	Dong Ah	3

* = Premium ** = Forst



Ventil TR 218 A



Ventil TRJ 1175 C

Artikel-Nr.	Größe	für Reifengröße	Ventil- bezeichnung	Ventil- ausführung	Marke	Ver- packungs- einheit
20800450	16.9/18.4 - 26	16.9-26 18.4-26 480/70-26 520/70-26 540/65-26 580/70-26	TR 218 A	Wasserfüllventil	BK Tube Masterline *	1
29800408	16.9/18.4 - 26	16.9-26 18.4-26 480/70-26 520/70-26 540/65-26 580/70-26	TR 218 A	Wasserfüllventil	Nexen	4
26020610	18.4 - 26	18.4-26 460/85-26 480/80-26 520/70-26 VF520/80-26	TR 218 A	Wasserfüllventil	Dong Ah	3
26020613	580/70 - 26	580/70-26 18.4-26 480/80-26 VF520/80-26 VF620/70-26	TR 218 A	Wasserfüllventil	Kleber *	1
20801040	23.1 - 26	23.1-26 580/70-26 620/70-26 620/75-26	TR 218 A	Wasserfüllventil	BK Tube Forestline */**	1
26020620	23.1 - 26	23.1-26 580/70-26 620/70-26 620/75-26	TR 218 A	Wasserfüllventil	Dong Ah	2
29800407	23.1 - 26	23.1-26 580/70-26 620/70-26 620/75-26	TR 218 A	Wasserfüllventil	Nexen	2
26020615	620/75 - 26	620/75-26 23.1-26 580/70-26 620/70-26	TR 218 A	Wasserfüllventil	Kleber *	1
20801050	28.1 - 26	28.1-26 28L26	TR 218 A	Wasserfüllventil	BK Tube Forestline */**	1
26020630	28.1 - 26	28.1-26 750/65-26	TR 218 A	Wasserfüllventil	Dong Ah	1
29800410	28.1 - 26	28.1-26 28L26	TR 218 A	Wasserfüllventil	Nexen	1
26030110	750/65 R 26	750/65R26	TR 218 A	Wasserfüllventil	Dong Ah	2
26020618	750/65 - 26	750/65-26 28.1-26	TR 218 A	Wasserfüllventil	Kleber *	1
26020635	28L - 26	28L-26	TR 218 A	Wasserfüllventil	Nokian */**	1
20801070	500/60 - 26.5	500/60-26.5 550/60-26.5 600/55-26.5	TR 218 A	Wasserfüllventil	BK Tube Forestline */**	1
27490640	500/60 - 26.5	500/60-26.5	TR 218 A	Wasserfüllventil	Dong Ah	2
29800411	500/60 - 26.5	500/60-26.5 550/60-26.5 600/55-26.5	TR 218 A	Wasserfüllventil	Nexen	1
29991732	500/60 - 26.5	500/60-26.5 540/60R26.5 480/65R28 500/65R28	TR 218 A	Wasserfüllventil	Nokian */**	1
27490660	600/55 - 26.5	600/55-26.5	TR 218 A	Wasserfüllventil	Dong Ah	2
29991733	600/55 - 26.5	600/55-26.5	TR 218 A	Wasserfüllventil	Nokian */**	1
20801080	650/65 - 26.5	650/65-26.5	TR 218 A	Wasserfüllventil	BK Tube Forestline */**	1
29800618	650/65 - 26.5	650/65-26.5	TR 218 A	Wasserfüllventil	Nexen	1
26020623	650/65 - 26.5	620/75-26.5 650/60-26.5 650/65-26.5 750/55-26.5 23.1-26	TR 218 A	Wasserfüllventil	Nokian */**	1
20801090	700/50 - 26.5	700/50-26.5 710/45-26.5	TR 218 A	Wasserfüllventil	BK Tube Forestline */**	1
27490680	700/50 - 26.5	700/50-26.5 710/45-26.5 710/50-26.5	TR 218 A	Wasserfüllventil	Dong Ah	1
29800412	700/50 - 26.5	700/50-26.5 710/45-26.5	TR 218 A	Wasserfüllventil	Nexen	1
29991712	700/50 - 26.5	700/50-26.5 710/45-26.5	TR 218 A	Wasserfüllventil	Nokian */**	1
20801100	750/55 - 26.5	750/55-26.5	TR 218 A	Wasserfüllventil	BK Tube Forestline */**	1
29800619	750/55 - 26.5	750/55-26.5	TR 218 A	Wasserfüllventil	Nexen	1

* = Premium ** = Forst



Ventil TR 218 A



Schläuche

Preise und Bestände finden Sie unter www.bohnenkamp.de/shop

Artikel-Nr.	Größe	für Reifengröße	Ventil-bezeichnung	Ventil-ausführung	Marke	Ver-packungs-einheit
20801110	800/40 - 26.5	800/40-26.5 800/45-26.5	TR 218 A	Wasserfüllventil	BK Tube Forestline */**	1
29800414	800/40 - 26.5	800/40-26.5	TR 218 A	Wasserfüllventil	Nexen	1
29991710	800/40 - 26.5	800/40-26.5 800/45-26.5	TR 218 A	Wasserfüllventil	Nokian */**	1
27490662	800/45 - 26.5	800/45-26.5	TR 218 A	Wasserfüllventil	Dong Ah	1
29920635	8.3 - 28	8.3-28 210/95-28	TR 218 A	Wasserfüllventil	Dong Ah	7
29800419	8.3 - 28	8.3-28 9.5-28 300/70-28	TR 218 A	Wasserfüllventil	Nexen	8
26020640	9.5 - 28	9.5-28 250/85-28	TR 218 A	Wasserfüllventil	Dong Ah	7
26020650	11.2 - 28	11.2-28 280/85-28 320/70-28	TR 218 A	Wasserfüllventil	Dong Ah	7
26020654	11.2 - 28	11.2-28 280/85-28 320/70-28	TR 218 A	Wasserfüllventil	Kleber *	1
29800417	11.2 - 28	11.2-28 11.2/10-28 280/85-28 12.4-28 320/70-28 320/80-28 360/70-28	TR 218 A	Wasserfüllventil	Nexen	5
20800460	11.2/12.4 - 28	11.2-28 12.4-28 280/85-28 320/70-28 320/85-28 360/70-28	TR 218 A	Wasserfüllventil	BK Tube Masterline *	2
26020660	12.4 - 28	12.4-28 320/85-28 360/70-28	TR 218 A	Wasserfüllventil	Dong Ah	5
26020663	360/70 - 28	12.4-28 320/85-28 360/70-28	TR 218 A	Wasserfüllventil	Kleber *	1
26020670	13.6 - 28	13.6-28 340/85-28 380/70-28	TR 218 A	Wasserfüllventil	Dong Ah	5
20800470	13.6/14.9 - 28	13.6-28 14.9-28 340/85-28 380/70-28 380/85-28 400/80-28 420/70-28 440/65-28	TR 218 A	Wasserfüllventil	BK Tube Masterline *	2
29800416	13.6/14.9 - 28	13.6-28 14.9-28 340/85-28 380/70-28 380/85-28 400/80-28 420/70-28 440/65-28	TR 218 A	Wasserfüllventil	Nexen	4
26020673	380/70 - 28	380/70-28 13.6-28 340/85-28 420/65-28	TR 218 A	Wasserfüllventil	Kleber *	1
26020680	14.9 - 28	14.9-28 380/85-28 420/70-28 16.5/85-28 400/80-28	TR 218 A	Wasserfüllventil	Dong Ah	5
26020690	16.9 - 28	16.9-28 420/85-28 440/80-28 480/70-28	TR 218 A	Wasserfüllventil	Dong Ah	3
29800418	16.9 - 28	16.9-28 18.4-28 18.4/15-28 480/65-28 480/70-28 540/65-28	TR 218 A	Wasserfüllventil	Nexen	4
20800480	16.9/18.4 - 28	16.9-28 18.4-28 420/85-28 440/80-28 480/65-28 480/70-28 540/65-28	TR 218 A	Wasserfüllventil	BK Tube Masterline *	2
26020698	540/65 - 28	16.9-28 18.4-28 420/85-28 440/80-28 480/65-28 480/70-28 540/65-28	TR 218 A	Wasserfüllventil	Kleber *	1
26030120	440/65 R 28	440/65R28	TR 218 A	Wasserfüllventil	Dong Ah	3
26020694	440/65 - 28	14.9-28 380/85-28 420/70-28 440/65-28 VF480/60-28	TR 218 A	Wasserfüllventil	Kleber *	1
26030130	480/65 R 28	480/65R28	TR 218 A	Wasserfüllventil	Dong Ah	3
26030140	540/65 R 28	540/65R28	TR 218 A	Wasserfüllventil	Dong Ah	3
29991728	540/65 - 28	500/70-28 540/65-28	TR 218 A	Wasserfüllventil	Nokian */**	1

* = Premium ** = Forst



Ventil TR 218 A

Artikel-Nr.	Größe	für Reifengröße	Ventil- bezeichnung	Ventil- ausführung	Marke	Ver- packungs- einheit
26030150	600/65 R 28	600/65R28	TR 218 A	Wasserfüllventil	Dong Ah	2
26020697	600/65 - 28	600/65-28 600/70-28	TR 218 A	Wasserfüllventil	Kleber *	1
26020699	600/70 - 28	600/65-28 600/70-28	TR 218 A	Wasserfüllventil	Dong Ah	1
29991744	780/50 - 28.5	710/55-28.5 780/50-28.5	TR 218 A	Wasserfüllventil	Nokian */**	1
26020700	14.9 - 30	14.9-30 420/70-30	TR 218 A	Wasserfüllventil	Dong Ah	4
29800424	14.9 - 30	14.9-30 15.5-30 16.9-30 420/70-30 480/70-30	TR 218 A	Wasserfüllventil	Nexen	3
20800485	14.9/16.9 - 30	14.9-30 16.9-30 420/85-30 440/80-30 480/70-30 480/80-30 540/65-30	TR 218 A	Wasserfüllventil	BK Tube Masterline *	1
27490682	420/70 - 30	14.9-30 380/85-30 420/70-30	TR 218 A	Wasserfüllventil	Kleber *	1
26020710	16.9 - 30	16.9-30 420/85-30 440/80-30 480/70-30	TR 218 A	Wasserfüllventil	Dong Ah	3
29800422	16.9 - 30	16.9-30 18.4-30 420/85-30 460/85-30 500/70-30 540/65-30	TR 218 A	Wasserfüllventil	Nexen	3
29991735	16.9/18.4 - 30	16.9-30 18.4-30 520/65-30 540/70-30	TR 218 A	Wasserfüllventil	Nokian */**	1
27490683	480/70 - 30	16.9-30 420/80-30 420/85-30 420/90-30 480/85-30 540/65-30	TR 218 A	Wasserfüllventil	Kleber *	1
26020720	18.4 - 30	18.4-30 460/85-30 480/80-30 520/70-30	TR 218 A	Wasserfüllventil	Dong Ah	2
27490686	18.4 - 30	18.4-30 460/85-30 480/80-30 520/70-30 VF600/60-30	TR 218 A	Wasserfüllventil	Kleber *	1
26030160	540/65 R 30	540/65R30	TR 218 A	Wasserfüllventil	Dong Ah	2
26030170	600/65 R 30	600/65R30	TR 218 A	Wasserfüllventil	Dong Ah	1
27490679	600/70 - 30	600/70-30 IF620/70-30 620/75-30 23.1-30	TR 218 A	Wasserfüllventil	Kleber *	1
26020730	23.1 - 30	23.1-30 620/75-30	TR 218 A	Wasserfüllventil	Dong Ah	2
29800423	23.1 - 30	21LR30 23.1-30 620/75-30	TR 218 A	Wasserfüllventil	Nexen	1

* = Premium ** = Forst



Ventil TR 218 A



Schläuche

Preise und Bestände finden Sie unter www.bohnenkamp.de/shop

Artikel-Nr.	Größe	für Reifengröße	Ventil- bezeichnung	Ventil- ausführung	Marke	Ver- packungs- einheit
27490515	600/55 - 30.5	600/55-30.5 600/60-30.5	TR 218 A	Wasserfüllventil	Dong Ah	2
29800426	600/55 - 30.5	600/55-30.5 600/60-30.5	TR 218 A	Wasserfüllventil	Kabat	2
27490517	700/50 - 30.5	650/60-30.5 700/50-30.5 710/50-30.5	TR 218 A	Wasserfüllventil	Dong Ah	1
29800425	700/50 - 30.5	700/50-30.5 800/45-30.5	TR 218 A	Wasserfüllventil	Nexen	1
27490518	750/60 - 30.5	750/60-30.5	TR 218 A	Wasserfüllventil	Dong Ah	1
27490519	800/45 - 30.5	800/45-30.5	TR 218 A	Wasserfüllventil	Dong Ah	1
27490520	850/50 - 30.5	850/50-30.5	TR 218 A	Wasserfüllventil	Dong Ah	1
20800495	8.3 - 32	8.3-32 210/95-32 9.5-32 230/95-32	TR 218 A	Wasserfüllventil	BK Tube Masterline *	4
26020740	8.3 - 32	8.3-32 210/95-32 9.5-30	TR 218 A	Wasserfüllventil	Dong Ah	8
29800429	8.3 - 32	8.3-32 210/95-32 9.5-32 230/95-32 260/70-32 300/70-32	TR 218 A	Wasserfüllventil	Nexen	6
26020750	9.5 - 32	9.5-32 230/95-32	TR 218 A	Wasserfüllventil	Dong Ah	8
26020755	11.2 - 32	11.2-32 270/95-32	TR 218 A	Wasserfüllventil	Dong Ah	5
27490710	11.2 - 32	11.2-32 270/95-32	TR 218 A	Wasserfüllventil	Kleber *	1
29800428	11.2 - 32	11.2-32 12.4-32 320/85-32 360/70-32	TR 218 A	Wasserfüllventil	Nexen	4
20800500	12.4 - 32	12.4-32 320/85-32 360/70-32	TR 218 A	Wasserfüllventil	BK Tube Masterline *	2
26020760	12.4 - 32	12.4-32 320/85-32 360/70-32	TR 218 A	Wasserfüllventil	Dong Ah	5
20800505	24.5 - 32	24.5-32 600/65-32 680/75-32	TR 218 A	Wasserfüllventil	BK Tube Masterline *	1
26020770	24.5 - 32	24.5-32 650/70-32	TR 218 A	Wasserfüllventil	Dong Ah	1
29800430	24.5 - 32	24.5-32 600/65-32 680/75-32	TR 218 A	Wasserfüllventil	Nexen	1
29991738	24.5 - 32	24.5-32	TR 218 A	Wasserfüllventil	Nokian */**	1
27490687	680/75 - 32	24.5-32 30.5-32 650/75-32 680/75-32 680/85-32 800/65-32 800/70-32 900/60-32	TR 218 A	Wasserfüllventil	Kleber *	1
20800510	30.5 - 32	30.5-32 800/65-32	TR 218 A	Wasserfüllventil	BK Tube Masterline *	1
26020780	30.5 - 32	30.5-32 800/65-32	TR 218 A	Wasserfüllventil	Dong Ah	1
29800427	30.5 - 32	30.5-32 800/65-32	TR 218 A	Wasserfüllventil	Nexen	1
29991736	30.5 - 32	30.5-32 700/70-34	TR 218 A	Wasserfüllventil	Nokian */**	1
26030180	800/65 R 32	800/65R32	TR 218 A	Wasserfüllventil	Dong Ah	1
26030190	900/60 R 32	900/60R32	TR 218 A	Wasserfüllventil	Dong Ah	1
29800431	18.00 - 33	18.00-33	TRJ 1175 C	Winkelventil	Nexen	1
20800525	16.9 - 34	16.9-34 16.9/14-34 380/85-34 420/85-38 18.4/15-34 480/70-34 520/70-34 540/65-34 600/60-34 600/65-34	TR 218 A	Wasserfüllventil	BK Tube Masterline *	1

* = Premium ** = Forst



Ventil TR 218 A



Ventil TRJ 1175C

Artikel-Nr.	Größe	für Reifengröße	Ventil-bezeichnung	Ventil-ausführung	Marke	Verpackungseinheit
26020790	16.9 - 34	16.9/14-34 380/85-34 420/85-34 440/80-34 480/70-34	TR 218 A	Wasserfüllventil	Dong Ah	3
29800432	16.9 - 34	16.9-34 16.9/14-34 380/85-34 420/85-38 18.4/15-34 480/70-34 520/70-34 540/65-34 600/60-34 600/65-34	TR 218 A	Wasserfüllventil	Nexen	3
29991737	16.9 - 34	16.9-34 18.4/15-34	TR 218 A	Wasserfüllventil	Nokian */**	1
26020800	18.4 - 34	18.4/15-34 460/85-34 480/80-34 520/70-34	TR 218 A	Wasserfüllventil	Dong Ah	2
27490690	18.4 - 34	18.4-34 460/85-34 480/80-34 520/70-34 VF600/60-34 600/65-34 IF650/60-34 IF650/65-34	TR 218 A	Wasserfüllventil	Kleber *	1
26030200	540/65 R 34	540/65R34	TR 218 A	Wasserfüllventil	Dong Ah	2
27490689	540/65 - 34	380/85-34 16.9-34 420/85-34 440/80-34 480/70-34 540/65-34	TR 218 A	Wasserfüllventil	Kleber *	1
20801130	600/65 - 34	600/65-34 700/55-34	TR 218 A	Wasserfüllventil	BK Tube Forestline */**	1
26030210	600/65 R 34	600/65R34	TR 218 A	Wasserfüllventil	Dong Ah	2
29991739	600/65 - 34	600/65-34 700/55-34	TR 218 A	Wasserfüllventil	Nokian */**	1
29800434	20.8 - 34	20.8-34 23.1-34 600/65-34 620/75-34	TR 218 A	Wasserfüllventil	Nexen	1
26020805	23.1 - 34	23.1-34 620/75-34	TR 218 A	Wasserfüllventil	Dong Ah	1
26030220	650/65 - 34	650/65-34	TR 218 A	Wasserfüllventil	Dong Ah	2
26020807	700/55 - 34	700/55-34	TR 218 A	Wasserfüllventil	Dong Ah	1
26030230	710/60 R 34	710/60R34	TR 218 A	Wasserfüllventil	Dong Ah	1
22420918	24.5 - 34	710/75-34	TR 218 A	Wasserfüllventil	Kleber *	1
29800440	4.00 - 36	4.00-36	TR 218 A	Wasserfüllventil	Kabat	15
29800439	7.2 - 36	7.2-36 7.2/7-36	TR 218 A	Wasserfüllventil	Nexen	5
26020810	8.3 - 36	8.3-36 210/95-36	TR 218 A	Wasserfüllventil	Dong Ah	6
29800437	8.3 - 36	8.3-36 8.3/8-36 9.5/9-36 210/95-36 230/95-36 260/70-36	TR 218 A	Wasserfüllventil	Nexen	5
26020820	9.5 - 36	9.5-36 230/95-36	TR 218 A	Wasserfüllventil	Dong Ah	6
26020830	11.2 - 36	11.2-36 270/95-36	TR 218 A	Wasserfüllventil	Dong Ah	5
27490697	11.2 - 36	11.2-36 12.4-36 270/95-36 320/85-36	TR 218 A	Wasserfüllventil	Kleber *	1
29800438	11.2 - 36	11.2-36 11.2/10-36 12.4/11-36 13.6/12-36 270/95-36 320/85-36 340/85-36 360/70-36 380/70-36	TR 218 A	Wasserfüllventil	Nexen	4
20800540	11.2/12.4 - 36	11.2-36 11.2/10-36 12.4/11-36 270/95-36 320/85-36 360/70-36 380/70-36	TR 218 A	Wasserfüllventil	BK Tube Masterline *	2
26020840	12.4 - 36	12.4-36 12.4/11-36 320/85-36 11.2-38	TR 218 A	Wasserfüllventil	Dong Ah	5
20800545	13.6 - 36	13.6-36 13.6/12-36 340/85-36	TR 218 A	Wasserfüllventil	BK Tube Masterline *	2
26020850	13.6 - 36	13.6-36 13.6/12-36 340/85-36	TR 218 A	Wasserfüllventil	Dong Ah	4
27490698	13.6 - 36	13.6-36 13.6/12-36 340/85-36	TR 218 A	Wasserfüllventil	Kleber *	1

* = Premium ** = Forst



Ventil TR 218 A



Schläuche

Preise und Bestände finden Sie unter www.bohnenkamp.de/shop

Artikel-Nr.	Größe	für Reifengröße	Ventil- bezeichnung	Ventil- ausführung	Marke	Ver- packungs- einheit
29800453	8.3 - 38	8.3-38 8.3/8-38 9.5/9-38	TR 218 A	Wasserfüllventil	Nexen	6
29800450	11.2 - 38	11.2-38 11.2/10-38 12.4/11-38 270/95-38 320/70-38 360/70-38	TR 218 A	Wasserfüllventil	Nexen	4
20800550	12.4 - 38	12.4-38 320/85-38	TR 218 A	Wasserfüllventil	BK Tube Masterline *	2
26020860	12.4 - 38	12.4-38 320/85-38	TR 218 A	Wasserfüllventil	Dong Ah	4
20800565	13.6 - 38	13.6-38 13.6/12-38 340/85-38	TR 218 A	Wasserfüllventil	BK Tube Masterline *	2
26020870	13.6 - 38	13.6-38 13.6/12-38 340/80-38 340/85-38 380/80-38 380/95-38	TR 218 A	Wasserfüllventil	Dong Ah	4
28690486	13.6 - 38	13.6-38 340/80-38 340/85-38 380/80-38 380/95-38 VF380/95-38	TR 218 A	Wasserfüllventil	Kleber *	1
29800448	13.6 - 38	13.6-38 13.6/12-38 340/85-38 14.9/13-38 15.5-38 380/70-38 400/75-38 420/70-38 480/70-38	TR 218 A	Wasserfüllventil	Nexen	3
20800555	15.5 - 38	15.5-38 400/75-38 420/85-38 480/70-38	TR 218 A	Wasserfüllventil	BK Tube Masterline *	
26020880	15.5 - 38	15.5-38 380/80-38 380/95-38 400/70-38	TR 218 A	Wasserfüllventil	Dong Ah	4
27490716	15.5 - 38	15.5-38 380/80-38 VF380/80-38 380/95-38 VF380/95-38 400/75-38	TR 218 A	Wasserfüllventil	Kleber *	1
26020890	16.9 - 38	16.9-38 16.9/14-38 420/85-38 480/70-38	TR 218 A	Wasserfüllventil	Dong Ah	3
29800443	16.9 - 38	16.9-38 16.9/14-38 420/85-38 18.4/15-38 480/70-38 480/80-38 520/70-38 540/65-38	TR 218 A	Wasserfüllventil	Nexen	3
28690485	480/70 - 38	14.9-38 16.9-38 420/85-38 480/70-38	TR 218 A	Wasserfüllventil	Kleber *	1
20800570	18.4 - 38	18.4-38 18.4/15-38 460/85-38 480/80-38 520/70-38 540/65-38	TR 218 A	Wasserfüllventil	BK Tube Masterline *	1
26020900	18.4 - 38	18.4-38 18.4/15-38 460/85-38 480/80-38 520/70-38 540/65-38	TR 218 A	Wasserfüllventil	Dong Ah	2
20800575	20.8 - 38	20.8-38 520/85-38 580/70-38 600/55-38 600/65-38 650/60-38 650/65-38	TR 218 A	Wasserfüllventil	BK Tube Masterline *	1
26020910	20.8 - 38	20.8-38 520/85-38 580/70-38 600/55-38 600/65-38 650/60-38 650/65-38	TR 218 A	Wasserfüllventil	Dong Ah	2
29800445	20.8 - 38	20.8-38 520/85-38 580/70-38 600/65-38 650/65-38	TR 218 A	Wasserfüllventil	Nexen	2
26030240	540/65 R 38	20.8-38 520/85-38 580/70-38 600/55-38 600/65-38 650/60-38	TR 218 A	Wasserfüllventil	Dong Ah	2
28690500	540/65 - 38	540/65-38 18.4-38 460/85-38 480/80-38 520/70-38 VF600/60-38	TR 218 A	Wasserfüllventil	Kleber *	1
26030250	600/65 R 38	580/70-38 600/65-38 620/70-38 650/65-38	TR 218 A	Wasserfüllventil	Dong Ah	1
29991729	600/70 - 38	600/70-38 650/75-38	TR 218 A	Wasserfüllventil	Nokian */**	1
26030260	650/65 R 38	20.8-38 620/70-38 650/65-38 710/60-38	TR 218 A	Wasserfüllventil	Dong Ah	1

* = Premium ** = Forst



Ventil TR 218 A

Artikel-Nr.	Größe	für Reifengröße	Ventil- bezeichnung	Ventil- ausführung	Marke	Ver- packungs- einheit
28690490	650/65 - 38	20.8-38 520/85-38 540/80-38 580/70-38 600/65-38 620/70-38 IF650/65-38 VF710/60-38	TR 218 A	Wasserfüllventil	Kleber *	1
20800580	650/85 - 38	650/85-38 710/70-38	TR 218 A	Wasserfüllventil	BK Tube Masterline *	1
26020909	710/70 - 38	650/75-38 650/85-38 700/65-38 710/60-38 710/70-38 710/85-38 800/70-38	TR 218 A	Wasserfüllventil	Dong Ah	1
29800616	710/70 - 38	650/85-38 710/70-38	TR 218 A	Wasserfüllventil	Nexen	1
28690505	710/70 - 38	650/75-38 650/85-38 IF650/85-38 710/70-38 IF710/85-38 800/70-38 IF800/70-38	TR 218 A	Wasserfüllventil	Kleber *	1
29800454	9.5 - 40	9.5-40 230/95-40	TR 218 A	Wasserfüllventil	Nexen	4
29800457	8.3 - 42	8.3-42 8.3/8-42 210/95-42 9.5/9-42 230/95-42 11.2/10-42 270/95-42	TR 218 A	Wasserfüllventil	Nexen	5
26020915	9.5 - 42	9.5-42 9.5/9-42 230/95-42	TR 218 A	Wasserfüllventil	Dong Ah	5
29920112	16.9 - 42	16.9-42 18.4-42 480/80-42	TR 218 A	Wasserfüllventil	Kleber *	1
20800586	18.4 - 42	18.4-42 18.4/15-42 20.8-42 480/80-42 520/85-42 580/70-42 620/70-42	TR 218 A	Wasserfüllventil	BK Tube Masterline *	1
29800455	18.4 - 42	18.4-42 18.4/15-42 20.8-42 480/80-42 520/85-42 580/70-42 620/70-42 650/65-42	TR 218 A	Wasserfüllventil	Nexen	1
22420990	18.4/16.9 - 42	18.4-42 460/85-42 480/80-42	TR 218 A	Wasserfüllventil	Dong Ah	2
29920100	20.8 - 42	20.8-42 580/70-42 620/70-42 650/65-42	TR 218 A	Wasserfüllventil	Dong Ah	2
29920110	20.8 - 42	20.8-42 460/85-42 480/80-42 520/85-42 620/70-42 650/65-42 VF710/60-42 710/70-42 IF710/70-42 IF710/75-42	TR 218 A	Wasserfüllventil	Kleber *	1
26030280	650/65 - 42	650/65-42 VF710/60-42 710/70-42 IF710/70-42 IF710/75-42	TR 218 A	Wasserfüllventil	Dong Ah	1
29800617	710/70 - 42	650/75-42 650/85-42 VF710/60-42 710/70-42 IF710/70-42 IF710/75-42	TR 218 A	Wasserfüllventil	Nexen	1
20800585	710/70 - 42	650/75-42 650/85-42 VF710/60-42 710/70-42 IF710/70-42 IF710/75-42	TR 218 A	Wasserfüllventil	BK Tube Masterline *	1
29800458	8.3 - 44	8.3-44 8.3/8-44 210/95-44 9.5/9-44 9.5-44 230/95-44 11.2-44 11.2/10-44 270/95-44	TR 218 A	Wasserfüllventil	Nexen	5
26020920	9.5 - 44	9.5/9-44 230/95-44	TR 218 A	Wasserfüllventil	Dong Ah	5
20800590	11.2 - 44	11.2-44 11.2/10-44	TR 218 A	Wasserfüllventil	BK Tube Masterline *	4
29920560	11.2 - 44	11.2-44 11.2/10-44 270/95-44	TR 218 A	Wasserfüllventil	Dong Ah	5
27490718	11.2 - 44	11.2-44 270/95-44	TR 218 A	Wasserfüllventil	Kleber *	1

* = Premium



Ventil TR 218 A



Schläuche

Preise und Bestände finden Sie unter www.bohnenkamp.de/shop

Artikel-Nr.	Größe	für Reifengröße	Ventil- bezeichnung	Ventil- ausführung	Marke	Ver- packungs- einheit
29920570	12.4 - 46	12.4-46 12.4/11-46 300/95-46 320/90-46 380/90-46	TR 218 A	Wasserfüllventil	Dong Ah	3
29800459	12.4 - 46	12.4/46 12.4/11-46 270/95-46 300/95-46 320/90-46 380/90-46 420/80-46 420/85-46	TR 218 A	Wasserfüllventil	Nexen	2
20800600	12.4/13.6/14.9 - 46	12.4/46 12.4/11-46 270/95-46 300/95-46 320/90-46 380/90-46 420/80-46	TR 218 A	Wasserfüllventil	BK Tube Masterline *	2
29920120	14.9 - 46	14.9-46 12.4-46 300/95-46 320/90-46 380/90-46 VF380/90-46 420/80-46 420/85-46	TR 218 A	Wasserfüllventil	Kleber *	1
29800460	16.9 - 46	16.9-46 420/80-46 18.4-46 520/85-46	TR 218 A	Wasserfüllventil	Nexen	2
20800601	16.9/18.4 - 46	16.9-46 420/80-46 18.4-46 480/80-46 520/85-46	TR 218 A	Wasserfüllventil	BK Tube Masterline *	1
27490720	18.4 - 46	18.4-46 20.8-46 480/80-46 VF480/80-46 520/85-46	TR 218 A	Wasserfüllventil	Kleber *	1
29920575	20.8 - 46	18.4-46 20.8-46 480/80-46 520/85-46	TR 218 A	Wasserfüllventil	Dong Ah	1
29920580	9.5 - 48	9.5-48 9.5/9-48 230/95-48	TR 218 A	Wasserfüllventil	Dong Ah	5
29800462	9.5 - 48	9.5-48 9.5/9-48 230/95-48 11.2-48 11.2/10-48 270/95-48	TR 218 A	Wasserfüllventil	Nexen	4
29920590	11.2 - 48	11.2-48 11.2/10-48 270/95-48 11.2-50	TR 218 A	Wasserfüllventil	Dong Ah	3
29920610	13.6 - 48	13.6-48 13.6/12-48 340/85-48 340/90-48	TR 218 A	Wasserfüllventil	Dong Ah	3
29800463	13.6 - 48	13.6-48 13.6/12-48 340/85-48 380/70-48	TR 218 A	Wasserfüllventil	Nexen	2
29920619	320/90 - 50	12.4-50 320/90-50 11.2-54 320/90-54	TR 218 A	Wasserfüllventil	Kleber *	1
20800610	16.9/18.4 R 50	16.9-50 18.4-50 480/95-50	TR 218 A	Wasserfüllventil	BK Tube Masterline *	1
29800620	16.9/18.4 - 50	16.9-50 18.4-50 480/95-50	TR 218 A	Wasserfüllventil	Nexen	1
20800620	11.2/12.4 - 52	270/95-52 300/95-52 11.2-54 270/95-54 320/90-54	TR 218 A	Wasserfüllventil	BK Tube Masterline *	1
29899005	11.2/12.4 - 52	270/95-52 300/95-52 11.2-54 270/95-54 320/90-54	TR 218 A	Wasserfüllventil	Nexen	3

* = Premium



Ventil TR 218 A

Wulstbänder

Artikel-Nr.	Größe	Gruppe	Breite mm	Marke
29800466	16 x 6 - 8 18 x 7 - 8 180/70 - 8	115 - 8	150	Nexen
29800468	4.00 - 8 5.00 - 8 15 x 4 1/2 - 8	85 - 8	100	Nexen
29991200	5.00 - 8	85 - 8	118/110	Dong Ah
29800467	190 - 8	130 - 8	150	Nexen
29800469	6.00 - 9 6.90 - 9	100 - 9	112	Nexen
29991050	6.00 - 9 10 - 9	100 - 9	118	Dong Ah
29800470	21 x 8 - 9	150 - 9	168	Nexen
29991300	6.50 - 10 7.50 - 10	130 - 10	150	Dong Ah
29800471	6.50 - 10 7.50 - 10	130 - 10	148	Nexen
29800472	7.0/85 - 10 23 x 9 - 10	165 - 10	155	Nexen
29800473	7.00 - 12	130 - 12	140	Nexen
29991350	7.00 - 12	130 - 12	140	Dong Ah
29800475	23 x 10 - 12 27 x 10 - 12	210 - 12	210	Nexen
29800476	21 x 4 22 x 4 1/2 23 x 5 25 x 6	100 - 13	95	Kabat
29800478	10.00 - 15 28 x 9 - 15 250 - 15 300 - 15	190 - 15	195	Nexen
29800479	6.50 - 15 7.00 - 15 7.50 - 15 8.15 - 15 8.25 - 15	170 - 15	175	Nexen
29800480	5.50 - 15 6.00 - 15	115 - 15	150	Nexen
26091110	7.00 - 15 7.50 - 15	170 - 15	177	Dong Ah
26091100	8.25 - 15 9.00 - 15 250/300 - 15 28 x 9 - 15	190 - 15	195	Dong Ah
29800483	6.00 - 16 6.50 - 16 7.00 - 16 7.50 - 16	160 - 16	165	Nexen
26091200	6.50 - 16 7.00 - 16 7.50 - 16	160 - 16	170	Dong Ah
29800484	8.25 - 16 9.00 - 16	190 - 16	180	Nexen
29800491	12.00 - 18 13.00 - 18	265 - 18	260	Nexen
29800500	6.50 - 20 7.00 - 20 7.50 - 20	170 - 20	180	Nexen
26091300	6.50 - 20 7.00 - 20 7.50 - 20 8.25 - 20	180 - 20	198	Dong Ah
29800498	8.25 - 20 9.00 - 20 10.00 - 20	180 - 20	180	Nexen
26091400	8.25 - 20 9.00 - 20	200 - 20	179	Dong Ah
29800502	8.25 - 20 9.00 - 20 10.00 - 20	190 - 20	190	Nexen
29800497	10.00 - 20 11.00 - 20 12.00 - 20 13 / 80 - 20	200 - 20	205	Nexen
26091500	10.00 - 20 11.00 - 20 12.00 - 20	210 - 20	208	Dong Ah
29800501	11.00 - 20 12.00 - 20 13.00 - 20 13 / 80 - 20 14.00 - 20	230 - 20	255	Nexen
26091600	13.00 - 20 14.00 - 20	235 - 20	241	Dong Ah
29800496	12.5 - 20 14.5 - 20 16.00 - 20	310 - 20	305	Nexen
29800503	14.00 - 20 14 / 80 - 20	280 - 20	305	Nexen
26091610	16.00 - 20	300 - 20	300	Dong Ah
29800505	12.00 - 24 13.00 - 24 14.00 - 24	220 - 24	215	Nexen
26091730	12.00 - 24	220 - 24	231	Dong Ah
29800507	13.00 - 24 14.00 - 24	260 - 24	252	Nexen
26091740	13.00 - 24 14.00 - 24	260 - 24	256	Dong Ah
29800506	16.00 - 24 16.00 - 25	275 - 24	252	Nexen
26091750	15.5 - 25 17.5 - 25	310 - 25	360	Dong Ah
29800510	17.5 - 25 18.00 - 25	360 - 25	390	Nexen
26091780	20.5 - 25	440 - 25	420	Dong Ah
29800515	20 - 24 20.5 - 25	440 - 25	465	Nexen
26091790	23.5 - 25	495 - 25	509	Dong Ah



Dichtringe und Zwischenringe

Preise und Bestände finden Sie unter www.bohnenkamp.de/shop

O-Ringe

Artikel-Nr.	Zollgröße	Ringstärke [mm]	Zusatzinformation
20991110	MPT-/EM-Reifen 20 Zoll	6,50	OR 2-20
20991113	EM Reifen 20 Zoll	6,50	OR 2-20
20991122	EM Reifen 24 Zoll	6,00	OR 2-24 / Heupo
20991123	EM Reifen 24 Zoll	6,50	OR 2-24 / Heupo
20991132	EM Reifen 25 Zoll	6,00	OR 2-25 / Heupo
29800524	EM Reifen 25 Zoll	6,50	OR 2-25 / Heupo
20991142	EM Reifen 25 Zoll	9,00	OR 3-25 / Sulla
29800526	EM Reifen 25 Zoll	9,65	OR 3-25 / Sulla
29800535	EM Reifen 29 Zoll	9,65	OR 3-29 / Sulky
20991129	EM Reifen 32 Zoll	6,50	OR 2-32
29800529	EM Reifen 33 Zoll	9,50	OR 3-33 / Strix
29800538	EM Reifen 33 Zoll	9,65	OR 3-33 / Strix
29800530	EM Reifen 35 Zoll	9,50	OR 3-35 / Strass
29800539	EM Reifen 35 Zoll	9,65	OR 3-35 / Strass
20991173	EM Reifen 39 Zoll	9,65	OR 3-39 / Fuodi
20991176	EM Reifen 45 Zoll	10,00	OR 3-45
20991177	EM Reifen 49 Zoll	10,00	OR 3-49 / Heyco

Winkeldichtringe

Artikel-Nr.	Größe
29800520	Winkeldichtring Tyran 20 Zoll (F20 Pilote)
29800525	Winkeldichtring Iceru 25 Zoll (F25)



O-Ringe und Dichtringe

Dichtwulstbänder

Artikel-Nr.	Größe	Ventil	Zusatzinformation
26091510	Dichtwulstband TSFT 150 / 75 R 8 , 180 / 70 R 8	TR-178	150 / 75 R 8, 180 / 70 R 8
26091520	Dichtwulstband TSFT 6.50 R 10	TR-178	6.50 R 10, BKT LM-81
26091542	Dichtwulstband TSFT 7.00 R 12	TR-178	7.00 R 12, BKT LM-81
26091541	Dichtwulstband TSFT 7.00/7.50/8.25 R 15	TR-178	7.00/7.50/8.25/225-75/250-70 R 15, BKT LM-81
10000087	Dichtwulstband TSFT 8.25/225-75/250-70/315-70 R15	TR-178	8.25/225-75/250-70/315-70 R15
26091540	Dichtwulstband TSFT 10.00/11.00/12.00 R 20	TR-178	10.00 R 20 BKT LM-81, 11.00 R 20, BKT LM-81

Zwischenringe

Artikel-Nr.	Zwischenring	passend zu Felge	Maße [mm]	Bezeichnung
29999300	für Bagger 10.00-20	7.0 - 20 als ET +153	46 x 460 x 820	754625
29999301	für Bagger 10.00-20	7.5 - 20 als ET +155	46 x 440 x 820	754425
29999302	für Bagger 10.00-20	7.5 - 20 als ET +165	60 x 460 x 820	754642
29999303	für Bagger 10.00-20	7.5 - 20 als ET +173.5	70 x 460 x 820	754655



Dichtwulstband



Zwischenring

376

Reifenaufbau

378

Reifenherstellung

379

Reifenbeschriftungen

380

**Tragfähigkeit und
Geschwindigkeitsindex**

382

Reifenhandling und Gewicht

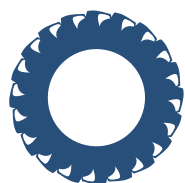

GRUNDLAGEN REIFEN



SERVICE-PLUS BY BOHNENKAMP

Erhalten Sie direkten Zugriff
auf unseren Online-Shop



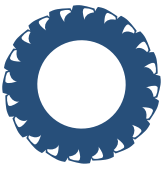

Grundlagen Reifen

Aufbau eines Reifens

Ein Reifen besteht aus verschiedenen Bestandteilen. Die Lauffläche ist der Teil, der direkt auf dem Ackerboden bzw. der Straße aufliegt. Diese besitzt das so genannte Profil, welches sich je nach Art und Einsatzgebiet des Reifens unterscheidet. Die Lauffläche ist auch der meistbeanspruchte Teil des Reifens und ist Abrieb und Verwitterung ausgesetzt.

Die Karkasse ist das eigentliche Gerüst des Reifens. Sie ist aus mehreren Gewebeschichten, Kunstfasern oder Kunstseide bzw. Stahlbändern aufgebaut, die in hartem Gummi eingebettet sind. Verschiedene Gürtel und Laufstreifen gewährleisten die Festigkeit. Die innere Wand (Inliner oder Innerling) besteht aus einer besonderen Gummimischung, die verhindert, dass bei schlauchlosen Reifen die eingeschlossene Luft mit der Zeit durch die Poren nach außen dringt.

Die Seitenwände (Flanken) schützen die Karkasse vor äußerer Einwirkung und Zerstörung. Der so genannte Wulst verbindet den Reifen mit der Felge. Er besteht hauptsächlich aus Stahldrähten.

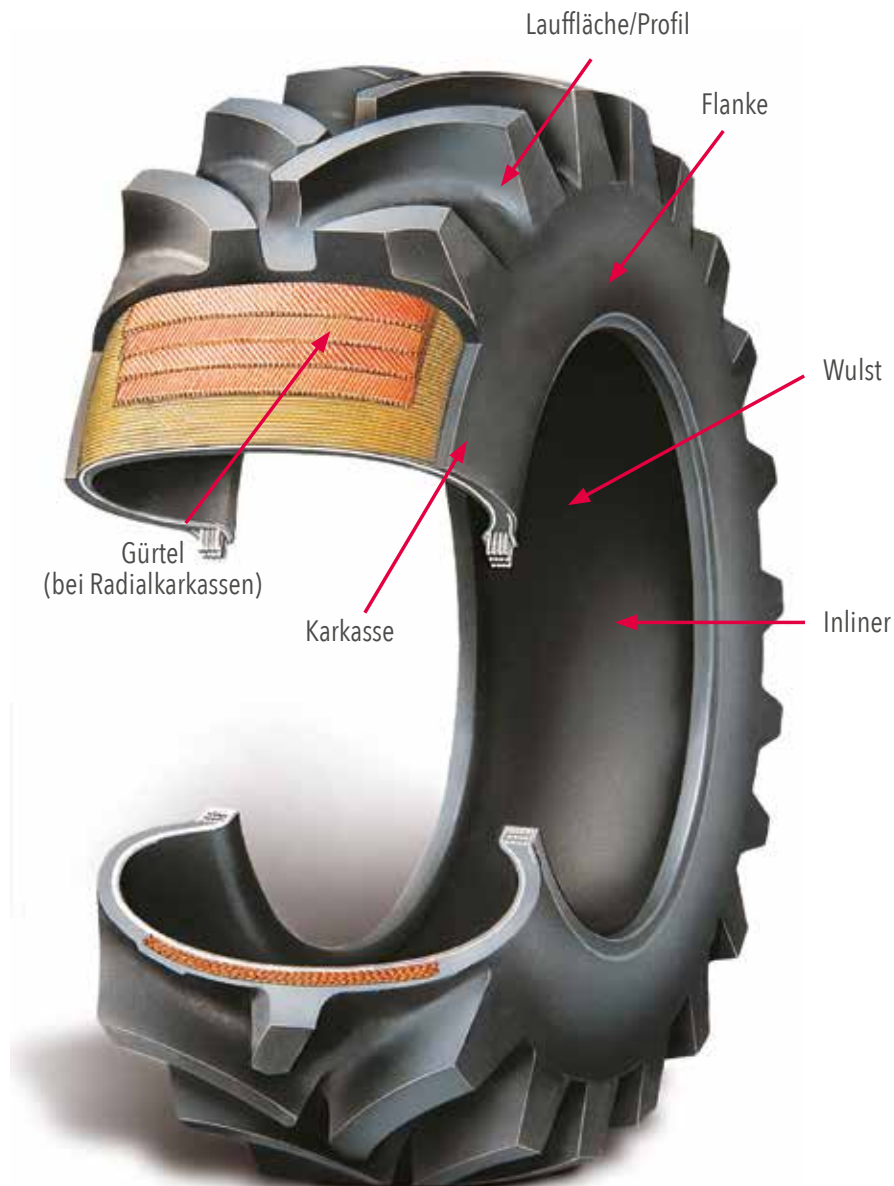

Bauarten von Reifen: Diagonal und Radial

Abhängig von der Bauart unterscheiden wir zwei Reifentypen: den Radial- und den Diagonalreifen. Die beiden Reifentypen verfügen über verschiedene Eigenschaften, die für unterschiedliche Einsatzgebiete vorteilhaft sind. Auf modernen Traktoren und gezogenen Maschinen kommen inzwischen überwiegend Radialreifen zum Einsatz. In bestimmten Spezialbereichen wie etwa der Forstwirtschaft ist aufgrund der produktspezifischen Besonderheiten aber noch immer die Verwendung von Diagonalreifen sinnvoll.

Diagonalreifen

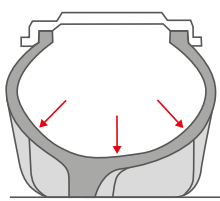

Diagonalkarkasse



Bodenkontaktfläche

Bei diesem konventionellen Reifentyp bilden der Aufbau der Lauffläche und die Flanke des Reifens eine gemeinsame Einheit. Dadurch werden sämtliche Bewegungen der Flanke bis in die Lauffläche weitergeleitet, was zu einer hohen Eigenbewegung des Reifens führt.

Vorteile des Diagonalreifens:

- günstiger Anschaffungspreis
- geringe Anfälligkeit gegen Stichverletzungen (Bauart bedingt „härtere Reifen“)

Nachteile des Diagonalreifens:

- Schlupf am Boden (hohe Eigenbewegung)
- Druckspitzen in der Aufstandsfläche
- höherer Verschleiß
- geringere Zugkraft

Radialreifen

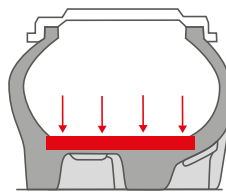

Radialkarkasse



Bodenkontaktfläche

Das Prinzip der Radialtechnik ermöglicht es den beiden Reifenzonen Flanke und Lauffläche, unabhängig voneinander zu arbeiten: Die Bewegungen der Flanke werden nicht in die Lauffläche übertragen, sodass Verschiebungen der Karkasslagen ausgeschlossen sind. Die unkontrollierte Eigenbewegung der Reifen, also der Schlupf am Boden, wird dadurch erheblich verringert.

Vorteile des Radialreifens:

- Verringerung des Schlupfes am Boden
- keine Verschiebungen zwischen den Karkasslagen
- gleichmäßige Lastverteilung in der Aufstandsfläche

Nachteile des Radialreifens:

- höherer Anschaffungspreis
- geringere Federeigenschaft des Reifens



**Expertenwissen
kompakt**

Vorteile des Radialreifens gegenüber Diagonalreifen:

- effektivere Zugkraft: Der Reifen rollt ab wie ein Laufband. Das bedeutet eine bessere Bodenschonung, eine höhere Traktion und geringeren Schlupf.
- reduzierter Kraftstoffverbrauch
- gleichmäßige Lastverteilung in der Aufstandsfläche sorgt für eine geringere Bodenverdichtung
- höhere Laufleistung
- Komfort und Geschmeidigkeit

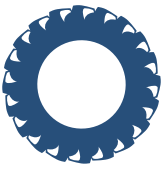

Grundlagen Reifen

Reifenherstellung

„Der Reifen eines Rades stellt den äußeren Umfang und die Lauffläche dar. Er überträgt die Kräfte zwischen Felge und Fahrbahn“. So einfach sich diese Definition aus Wikipedia anhört, so komplex ist der Prozess der Reifenherstellung an sich. Bis zu 45 verschiedene Rohstoffe wie Kautschuk, Silica, Ruß und Schwefel aber auch Stahl, Nylon und weitere Textilien werden benötigt, um einen modernen Landwirtschaftsreifen zu fertigen. (Tabelle 1) Je nach Einsatz kommen hierbei unterschiedliche Gummimischungen zum Einsatz. In einem ersten Schritt werden die verschiedenen Gummimischungen für die unterschiedlichen Bereiche des Reifens gefertigt (Lauffläche, Seitenwand, Inliner, Wulst, etc.)

Inhaltsstoffe eines Reifens und deren ungefähre Mengenverhältnisse:

~40%	bis zu elf Kautschukmischungen	Natur und Synthetik kautschuk
~30%	Füllstoffe	Ruß, Silica, Kohlenstoff, Kreide
10-15%	Festigkeitsträger	Stahl, Rayon, Nylon
~10%	Weichmacher	Öle und Harze
4-5%	Chemikalien zur Vulkanisierung	Schwefel, Zinkoxid
1-2%	Chemikalien zum Alterungsschutz	
1%	Sonstiges	

Tabelle 1

Nachdem die verschiedenen Gummimischungen hergestellt wurden, werden weitere Reifenbestandteile wie die Korde und Wulstdrähte gefertigt. Für die Korde werden Gewebbahnen aus Nylon, Polyester oder Stahl beidseitig mit einer dünnen Gummischicht versehen. Danach werden die Bahnen in bestimmten Winkeln zugeschnitten. Diese zugeschnittenen Bahnen werden zum Beispiel für die Karkassen und Gürtellagen verwendet.

Der Wulstkern entsteht, indem Stahldraht mit Gummi beschichtet und daraufhin fest auf eine Spule gewickelt wird. Die Anzahl der Wicklungen und der Durchmesser sind speziell an die Reifengröße und die Belastung angepasst.

Im ersten Schritt der Reifenherstellung wird eine luftundurchlässige Lage auf die Wickeltrommel gelegt. Sie bildet später die Innenschicht des Reifens und ist für dessen Dichtigkeit verantwortlich. Darüber werden eine oder mehrere Lagen aus gummiertem Stahl- oder Nylongewebe angebracht, welche die spätere Karkasse bilden. Zusammen mit zwei keilförmigen Wulstverstärkern werden die gewickelten Wulstkerne auf die Wickeltrommel aufgelegt. Zusammen bilden sie den Reifenwulst und garantieren einen festen Sitz des Reifens auf der Felge. Nachdem der Gummi für die Seitenwände aufgelegt wurde, bläht sich die Wickeltrommel von der Mitte her auf und die Reifenform wird erkennbar. Im Anschluss daran werden die Gürtellagen auf die fertige Karkasse gewickelt. Zum Schluss wird der Laufstreifen aufgelegt.

Zur Fertigstellung muss der Reifenrohling noch vulkanisiert werden. Dazu wird er in eine Form gelegt und unter Hitze und Druck „gebacken“, um die einzelnen Polymermoleküle miteinander zu verbinden. Nach der Vulkanisation besitzt der Reifen seine endgültige Form mit dem passenden Profil. In der darauf folgenden Endkontrolle wird der fertige Reifen auf Produktionsfehler überprüft.

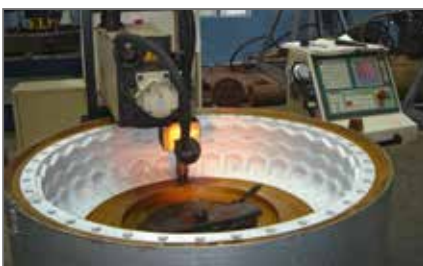

Reifenabmessungen und Beschriftungen

Weltweit sind Reifenhersteller in Verbänden organisiert. Die wichtigsten Verbände sind:

- ETRTO (European Tyre and Rim Technical Organisation, Brüssel)
- Tire + Rim Association (Hauptverband in den USA)

Gemeinsam mit der Internationalen Organisation für Normung (ISO) haben diese Verbände eine weltweit gültige Norm für ihre Produkte festgelegt.

Außendurchmesser

Der maximale Durchmesser in mm eines unbelasteten, auf der empfohlenen Felge montierten und vorschriftsmäßig (Betriebsluftdruck) aufgepumpten Reifens.

Querschnittsbreite

Die Breite des Reifens in mm, gemessen von Seitenwand zu Seitenwand eines unbelasteten, auf der empfohlenen Felge montierten und vorschriftsmäßig (Betriebsluftdruck) aufgepumpten Reifens.

Querschnittshöhe

Die Höhe der Flanke des Reifens. Diese wird in der Größenbezeichnung des Reifens in % zur Querschnittsbreite angegeben.

Statischer Halbmesser

Der Abstand von der Radmitte bis zur Standebene unter nominalen Belastungs- und Luftdruckbedingungen. Die gängige Maßeinheit hierfür ist mm.

Einfederung

Einfederung des Reifens im Stand bis maximal 10 km/h in % zur Querschnittshöhe. Diese darf bei einem Standardreifen maximal 18 % betragen.

Felgendurchmesser

Der von Wulstsitz zu Wulstsitz gemessene Durchmesser in mm.

Abrollumfang

Der Abrollumfang ist die Strecke, die ein Rad bei einer Umdrehung schlupffrei zurücklegt.

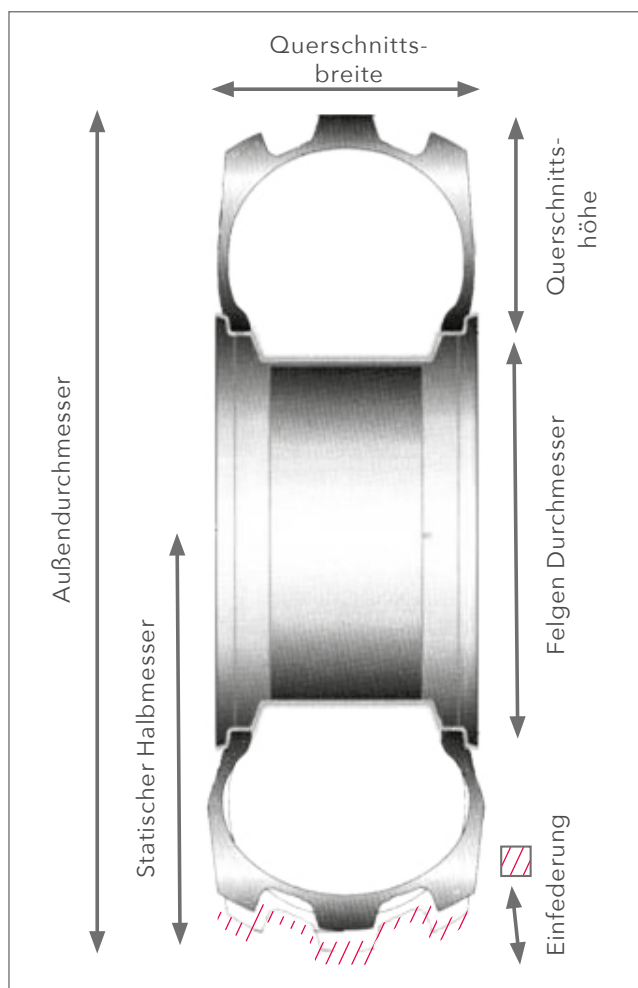

Wichtiger Hinweis

Viele Angaben sind vom Hersteller errechnete Werte. In der Praxis kann es u. U. zu kleinen Abweichungen kommen. Generell sind auf der Seitenwand (Flanke) des Reifens alle wichtigen Informationen vermerkt.

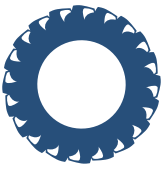

Grundlagen Reifen

Größen- und Profilbezeichnung

Auf der Seitenwand (Flanke) finden Sie alle wichtigen Informationen über den Reifen, auch die Größenbezeichnung und die exakte Bezeichnung des Profils.

Die international gültige Größendefinition wurde in den vergangenen Jahren von Zoll auf eine metrische Bezeichnung umgestellt. Auf einzelnen Reifen sind auch beide Maßeinheiten zu finden.



Neue Kennzeichnung

- 420** Breite des Reifens in mm
- 80** Höhenverhältnis der Flanke zur Breite in %
- R** Radial
- 46** Felgendurchmesser in Zoll

Alte Kennzeichnung

- 16.9** Breite des Reifens in Zoll
- R** Radial
- 46** Felgendurchmesser in Zoll



AS-Reifen von BKT

Profilbezeichnung

Jeder Hersteller hat für sein Profil eine eigene Bezeichnung. Diese befindet sich ebenfalls auf der Flanke des Reifens.

Tragfähigkeit und Geschwindigkeitsindex

Ebenfalls auf der Flanke des Reifens finden Sie den Tragfähigkeits- und Geschwindigkeitsindex (Last- und Speed-Index) sowie die Information, ob der Reifen mit oder ohne Schlauch gefahren werden kann. TL = Tubeless = ohne Schlauch, TT = Tube Type = mit Schlauch. Der Lastindex wird durch einen Nummerncode dargestellt. Dieser steht für die Tragfähigkeit des Reifens (siehe Tabelle „Lastindex“.) Der nachfolgende Buchstabe (oder Zahlen-Buchstabenkombination) kennzeichnet die Geschwindigkeit, bis zu der die Tragfähigkeit gewährleistet ist (siehe Speed-Index).



Die Kennzeichnung 166F bescheinigt dem Reifen eine Tragfähigkeit von 5.300 Kg bei 80 km/h.



Reifen mit der Bezeichnung **Tubeless** können ohne Schlauch gefahren werden. Reifen mit der Bezeichnung **Tube Type** müssen mit Schlauch gefahren werden.

Geschwindigkeitskennbuchstaben Speed Index (SI)

Kennbuchstabe	zul. km/h	Kennbuchstabe	zul. km/h	Kennbuchstabe	zul. km/h
A1	5	D	65	Q	160
A2	10	E	70	R	170
A3	15	F	80	S	180
A4	20	G	90	T	190
A5	25	J	100	U	200
A6	30	K	110	H	210
A7	35	L	120	V	240
A8	40	M	130	W	270
B	50	N	140	Y	300
C	60	P	150		

Tragfähigkeitskennzeichnung Last Index (LI)

LI	kg	LI	kg	LI	kg	LI	kg	LI	kg
50	190	79	437	108	1000	137	2300	166	5300
51	195	80	450	109	1030	138	2360	167	5450
52	200	81	462	110	1060	139	2430	168	5600
53	206	82	475	111	1090	140	2500	169	5850
54	212	83	487	112	1120	141	2575	170	6000
55	218	84	500	113	1150	142	2650	171	6150
56	224	85	515	114	1180	143	2725	172	6300
57	230	86	530	115	1215	144	2800	173	6500
58	236	87	545	116	1250	145	2900	174	6700
59	243	88	560	117	1285	146	3000	175	6900
60	250	89	580	118	1320	147	3075	176	7100
61	257	90	600	119	1360	148	3150	177	7300
62	265	91	615	120	1400	149	3250	178	7500
63	272	92	630	121	1450	150	3350	179	7750
64	280	93	650	122	1500	151	3450	180	8000
65	290	94	670	123	1550	152	3550	181	8250
66	300	95	690	124	1600	153	3650	182	8500
67	307	96	710	125	1650	154	3750	183	8750
68	315	97	730	126	1700	155	3875	184	9000
69	325	98	750	127	1750	156	4000	185	9250
70	335	99	775	128	1800	157	4125	186	9500
71	345	100	800	129	1850	158	4250	187	9750
72	355	101	825	130	1900	159	4375	188	10000
73	365	102	850	131	1950	160	4500	189	10300
74	375	103	875	132	2000	161	4625	190	10600
75	387	104	900	133	2060	162	4750	191	10900
76	400	105	925	134	2120	163	4875	192	11200
77	412	106	950	135	2180	164	5000	193	11500
78	425	107	975	136	2240	165	5150	194	11800

Zuordnung Belastung - Geschwindigkeiten

Zulässige Tragfähigkeit in % der Tabellenwerte		
Höchstgeschwindigkeit km/h	Referenzgeschwindigkeit 30 km/h bei PR bzw. A6-Kennzeichnung	Referenzgeschwindigkeit 40 km/h bei A8-Kennung und 50 km/h B-Kennung
50	/	91
40	80	100
35	90	103
30	100	107
25	107	111
20	120	123
10	140	150

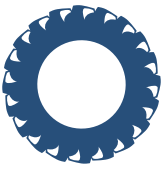

Grundlagen Reifen

DOT-Nummer

Auf der Seitenwand eines Reifens finden Sie neben den Hinweisen zu Größe, Hersteller, Ausführung und Profil auch das Herstellungsdatum. Es ist Teil der sogenannten DOT-Nummer (North American Department of Transportation).

Diese Nummernfolge unterscheidet sich je nach Hersteller. Produktionsmonat und Jahr sind entweder am Anfang oder am Ende der Ziffernreihe zu finden. Ab 2000 bezeichnen die ersten zwei Ziffern die Produktionswoche und die dritte und vierte Ziffer das Produktionsjahr. (Beispiel 2311 = 23. Woche des Jahres 2011). Bei Reifen, die vor dem Jahr 2000 hergestellt wurden, bezeichnet lediglich die dritte Ziffer das Herstellungsjahr.



Reifenalter

Nicht nur die Be- und Abnutzung der Reifen lässt diese altern: Der Alterungsprozess ist in hohem Maße durch physikalische und chemische Prozesse bedingt. Um dem entgegenzuwirken, werden den Materialmischungen bei der Reifenherstellung bestimmte Substanzen beigegeben. Sie gewährleisten, dass ein auch über mehrere Jahre sachgemäß gelagerter Reifen der Spezifikation eines Neureifens entspricht und in seiner Verwendungstauglichkeit nicht beeinträchtigt ist.

Der Bundesverband Reifenhandel und Vulkaniseur-Handwerk e.V. (kurz BRV) hat im Herbst 2001 mit den maßgeblichen Reifenherstellern eine exakte Definition der Formulierung „mehrere Jahre sachgemäß gelagert“ vorgenommen. Diese legt fest, dass ein bis zu maximal fünf Jahre gelagerter Reifen der Spezifikation Neureifen entspricht. Sachgemäß gelagert bedeutet hierbei eine trockene, vor Witterungseinflüssen geschützte Lagerung (in der Halle). Diese Definition hat auch in die Rechtsprechung Einzug gehalten, und sind damit eindeutig geklärt.

Für im Einsatz befindliche Reifen wird empfohlen, diese ab einem Alter von zehn Jahren nur noch dann zu benutzen, wenn sie zuvor ständig unter normalen Bedingungen im Einsatz waren. Diese Reifen sollten also nicht mehr umgesteckt, sondern ausschließlich im gewohnten, laufenden Betrieb gefahren werden. In bestimmten Einsatzbereichen sollte jedoch eine kürzere Nutzungsdauer die Regel sein: Besonders bei stark alternden Reifen an Wohnwagen empfiehlt es sich, die Reifen schon nach sechs, spätestens aber nach acht Jahren zu ersetzen.



**Expertenwissen
kompakt**

Definition Reifenalter:

Fabrikneuer Reifen:

bis zu 3 Jahren

Neuer Reifen:

bis zu 5 Jahren

Grundsätzliche Lebensdauer:

bis zu 10 Jahren



Reifenlagerung

Neue Reifen sollen grundsätzlich kühl, trocken, dunkel und in gut belüfteten Räumen gelagert werden. Der Kontakt mit Lösungsmitteln und Chemikalien sowie Kraft- und Schmierstoffen ist zu vermeiden.

Eine längere Lagerung unter freiem Himmel kann den Alterungsprozess des Reifens beschleunigen und zu Schäden am Produkt führen.

Reifengewichte (Auswahl)

Dimension				Gewicht
320/65	R	16		30
420/65	R	24		58
440/65	R	24		70
480/65	R	24		82
540/65	R	24		102
11.2	R	24		39
12.4	R	24		45
13.6	R	24		60
14.9	R	24		72
16.9	R	24		91
540/65	R	26		106
580/70	R	26		124
620/70	R	26		141
16.9	R	26		95
440/65	R	28		77
480/65	R	28		85
540/65	R	28		111
600/70	R	28		180
12.4	R	28		52
340/85	R	28		67
380/85	R	28		78
420/85	R	28		97
710/55	R	30		204
540/65	R	30		122
480/70	R	30		115
600/70	R	30		185
380/85	R	30		83
420/90	R	30		106
18.4	R	30		130

Dimension				Gewicht
12.4	R	32		64
900/60	R	32		369
540/65	R	34		126
480/70	R	34		126
600/65	R	34		148
12.4	R	34		64
380/85	R	34		85
420/85	R	34		111
18.4	R	34		129
12.4	R	38		66
13.6	R	38		84
14.9	R	38		96
16.9	R	38		119
540/65	R	38		134
600/65	R	38		179
650/65	R	38		193
710/70	R	38		310
800/70	R	38		367
620/70	R	38		263
650/75	R	38		325
480/80	R	38		142
520/85	R	38		184
650/85	R	38		354
650/65	R	42		252
710/70	R	42		335
620/70	R	42		290
480/85	R	42		176
520/85	R	42		213
420/80	R	46		140

Dies ist nur eine Auswahl.

Weitere Gewichtsangaben finden Sie in unserem Online-Shop.

386

Bodenschonung

388

Erklärung von Fachbegriffen

390

V-Flecto

392

Luftdruckeinstellung

394

Einsatzoptimierung im Betrieb



**BODENSCHONUNG UND
EINSATZOPTIMIERUNG**

SERVICE-PLUS BY BOHNENKAMP

Erhalten Sie direkten Zugriff
auf unseren Online-Shop





Bodenschonung und Einsatzoptimierung

Bodenschonung

Die Verdichtung bzw. Schonung des Bodens ist von besonderer Bedeutung für die zukünftige Ertragssituation. Durch den Kontaktflächen-
druck zwischen Reifen und Boden entstehen Druckspannungen im Boden. Diese Druckspannungen führen zu einer Zunahme der Lagerungs-
dichte und vermindern den Anteil an Luft- und Wasserporen im Boden.

Der Boden wird also durch das Befahren verdichtet, das Pflanzenwachstum behindert und folglich die Erträge vermindert. Bodenschonen-
de Reifen minimieren die Bodenverdichtungen, greifen die Ressourcen weniger an und wirken einer Beeinträchtigung der Ernteerträge
entgegen (Abb. 1).

Bodendruckverteilung bei verschiedenen Reifen



Abbildung 1

Aufstandsfläche Standardreifen vs. Breitreifen



Abbildung 2

Die wichtigste Maßnahme zur Verringerung des Bodendrucks ist die Umbereifung des Fahrzeugs auf Breitreifen. Hierdurch wird die gleiche
Last auf eine größere Aufstandsfläche verteilt, was zu einer deutlichen Verringerung des spezifischen Bodendrucks führt.

Gleichzeitig ermöglicht die höhere Anzahl der im Eingriff befindlichen Stollen des Reifenprofils das Wirken höherer Zugkräfte bei geringerem
Schlupf (Abb. 2 und 3).



**Expertenwissen
kompakt**

**Der spezifische Bodendruck lässt sich nach folgender
Formel berechnen:**

Spezifischer Bodendruck =
Reifeninnendruck (bar) + Zuschlag für Seitensteifigkeit

Bodendruckverteilung bei verschiedenen Reifenbreiten



Abbildung 3

Verringerung des Bodendrucks bei gleichem Reifendurchmesser und Radlast.

Durch die Umstellung eines Traktors auf eine breitere Bereifung lässt sich der Bodendruck deutlich verringern. (Tabelle 1.)
 Hierbei sind einige Faktoren zu beachten. Weitere Informationen hierzu finden sie in dem Kapitel „Umbereifung“ ab Seite 380.

Größe	LI	Fülldruck (bar)	Zuschlag Seitensteifigkeit (bar)	Bodendruck (daN/cm ²)	Reduktion gegenüber Standard (%)
20.8 R 38	153 A8	1,6	0,15	1,75	0
520/85 R 38	155 A8	1,45	0,1	1,55	11
580/70 R 38	155 A8	1,4	0,1	1,5	14
650/65 R 38	157 A8	1,2	0,05	1,25	29
800/65 R 32	167 A8	0,6	0,1	0,7	60
900/60 R 32	178 A8	0,4	0,1	0,5	71

Tabelle 1: 3650 kg am Beispiel 20.8 R 38/520/85 R 38

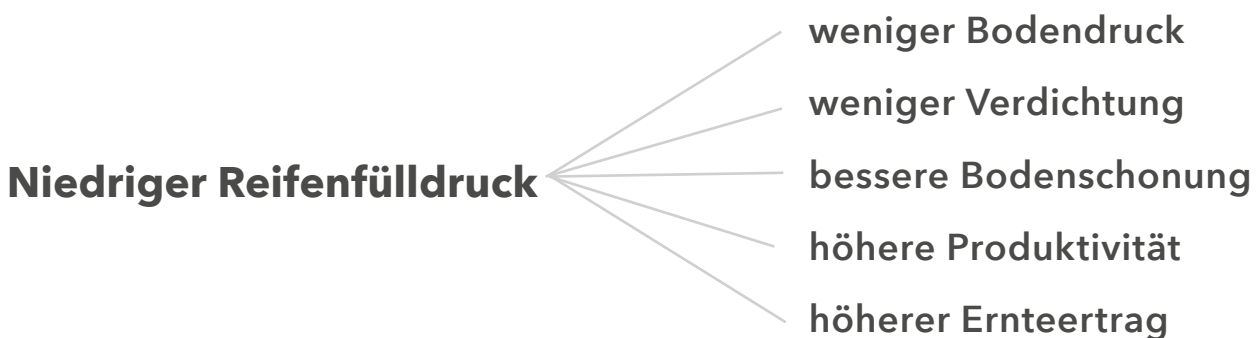



Bodenschonung und Einsatzoptimierung

Der Multipass-Effekt

Als Multipass-Effekt wird das Befahren der gleichen Spur mit Vorder- und Hinterrädern bezeichnet. Indem die Vorderräder den Boden vorverdichten, ermöglichen sie die höhere Zugkraftübertragung der Hinterräder. Je größer die Vorräder umso größer ist hierbei der Multipass-Effekt. Den größten Multipass-Effekt erzielen Allradtraktoren mit vier gleich großen Rädern.

IF-/VF-Reifentechnologie

Für eine besonders gute Bodenschonung eignen sich Reifen, welche mit der IF- oder VF-Technologie ausgestattet sind. IF-Reifen (Improved/Increased Flexion-Reifen) bieten die Möglichkeit, bei bis zu 20 % geringerem Fülldruck die gleiche Traglast oder bei gleichbleibendem Fülldruck 20 % mehr Tragfähigkeit zu leisten, als vergleichbare Reifen ohne IF-Technologie. Bei VF-Reifen (Very High Flexion-Reifen) betragen die Änderungen sogar bis zu 40 %. Dieses wird durch einen veränderten Karkassenaufbau gewährleistet, die Karkassenlagen sind dünner, jedoch wurde die Anzahl der Lagen erhöht.

Zusätzlich erfolgt der Lagenumschlag weniger abrupt. Damit wird die Gefahr der Lagenseparation deutlich verringert, was sonst bei hoher Belastung und gleichzeitig geringem Luftdruck passiert.

Die dadurch flachere Lauffläche ermöglicht eine bessere Verzahnung der Stollen im Boden. In Verbindung mit einem gesenkten Luftdruck wird so eine optimale Bodenschonung erreicht.

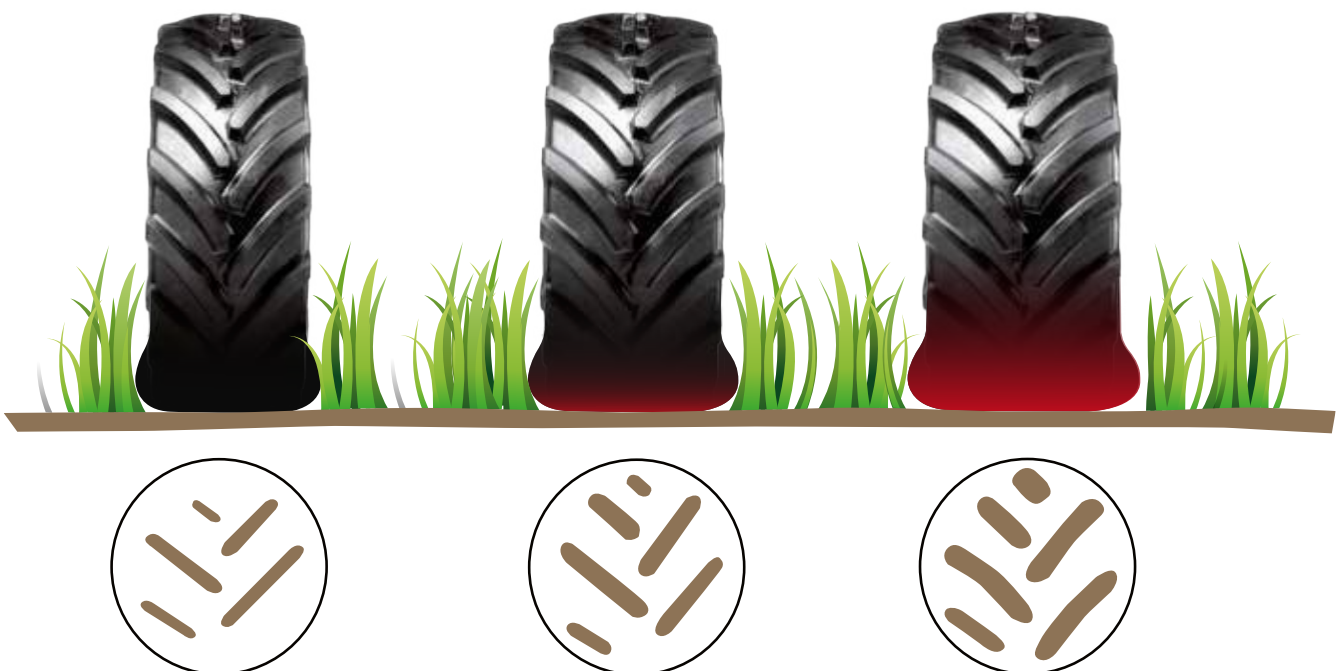
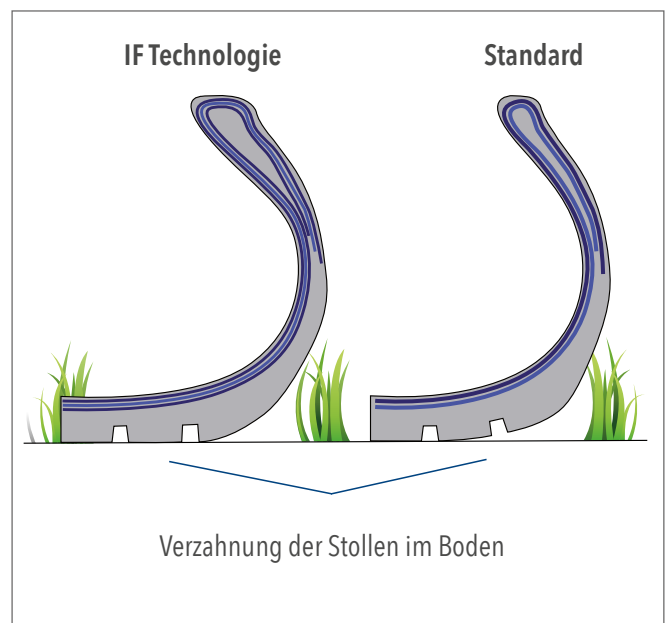

Zyklischer Feldeinsatz / Cyclic Field Operation (CFO)

Moderne Erntemaschinen sollen zugleich schlagkräftig und bodenschonend zum Einsatz kommen. Das hohe Gewicht der Maschinen, welches vor allem durch die gesteigerten Korntank- und Bunkerkapazitäten hervorgerufen wird, erfordert eine spezielle Luftdruckanpassung der Reifen. Erntemaschinenreifen, welche mit der IF- und VF-Technologie ausgestattet sind, verfügen über die Fähigkeit, mit einem sehr geringen Luftdruck bei gleichbleibend hoher Tragfähigkeit gefahren zu werden.

Man spricht in diesem Fall vom sog. Zyklischen Feldeinsatz bzw. Cyclic Field Operation (kurz: CFO). Bei Erntemaschinen, wie Mähreschern oder Rübenrodern, erfolgt eine Belastungszunahme und -abnahme in Intervallen. Der Korntank bzw. Bunker füllt sich während des Einsatzes stetig und wird dann schlagartig entleert. Der Reifen ist somit nur für kurze Zeit unter voller Auslastung und kann sich nach dem Entleerungsvorgang langsam wieder abkühlen, sodass es zu keiner Überlastung kommt. Zu beachten ist, dass nicht mehr als ungefähr 1,5 km unter voller Auslastung gefahren werden sollten (zum Abbunkern bzw. Korntankentleeren).

Zyklischer Feldeinsatz CFO (Cyclic Field Operation)

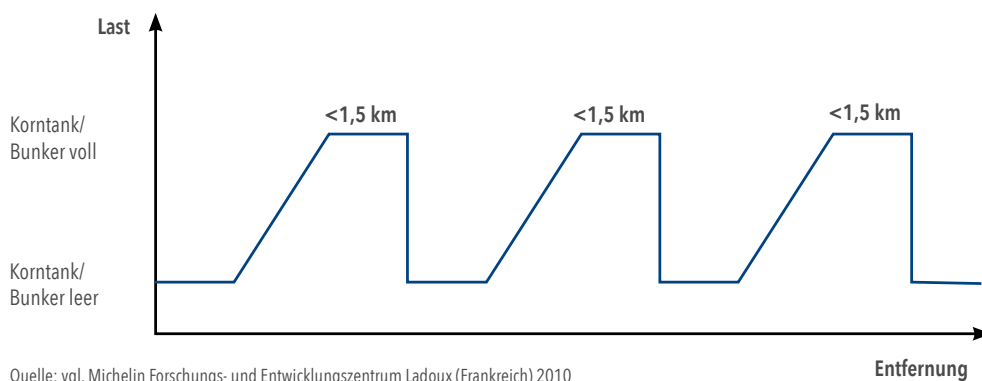

Quelle: vgl. Michelin Forschungs- und Entwicklungszentrum Ladoux (Frankreich) 2010

Beispiel-Dimensionen:

IF 680/85 R 32 CFO
IF 800/65 R 32 CFO
IF 800/70 R 32 CFO
IF 1050/50 R 32 CFO
IF 800/70 R 38 CFO

Spezielle Kennzeichnung für Hightech-Reifen

- | | |
|---------------------------|--|
| IF Technologie | Improved Flexion - bis zu 20% niedrigerer Reifenfülldruck bei gleicher Last oder bis zu 20% höhere Tragfähigkeit bei gleichem Reifenfülldruck |
| VF Technologie | Very High Flexion - bis zu 40% niedrigerer Reifenfülldruck bei gleicher Last oder bis zu 40% höhere Tragfähigkeit bei gleichem Reifenfülldruck |
| IF CFO Technologie | Improved Flexion Cyclic Field Operation ⇒ IF-Reifen für zyklische Feldeinsätze |
| VF CFO Technologie | Very improved Flexion Cyclic Field Operation ⇒ VF-Reifen für zyklische Feldeinsätze |

High Load Variation (HLV) und Low Load Variation (LLV)

Unter Umständen kann auch bei Implement-Reifen eine Luftdruckanpassung vorgenommen werden oder sogar notwendig sein. Zu beachten gilt hierbei jedoch eine Unterscheidung der Anwendung in eine Hohe-Last-Variante (kurz: HLV, High Load Variation) und in eine Niedrige-Last-Variante (kurz: LLV, Low Load Variation).

Von einer HLV-Anwendung wird gesprochen, sofern der Belastungszustand des Reifens vom unbeladenen Zustand zum beladenen Zustand um mehr als das Doppelte variiert. Beispiele hierfür sind sämtliche Transportarbeiten mit Lade- und Überladewagen oder Transportfässern. In diesem Fall kann die Tragfähigkeit des Reifens mit einem erhöhten Luftdruck gegenüber dem Normluftdruck gesteigert werden.

Sind solche Belastungsänderungen nicht vorzufinden, so spricht man von einer LLV-Anwendung. Als Beispiel hierfür können Bodenbearbeitungs- und Futtererntemaschinen genannt werden. Sofern eine Unterscheidung zwischen HLV- und LLV-Anwendungen von Nöten ist, wird dies in den jeweiligen Luftdrucktabellen vermerkt.



Bodenschonung und Einsatzoptimierung

AGRIMAX V-FLECTO
RADIAL VF TECHNOLOGY TIRES



In Folge der Entwicklung, die Hochleistungstraktoren während der letzten Jahre sowohl hinsichtlich Technik als auch Leistung erleben, werden in Reifen dieselben Erwartungen gesetzt.

AGRIMAX V-FLECTO ist die Antwort von BKT auf diese Herausforderung. Dieser Reifen wartet mit hervorragenden Leistungen und Zuverlässigkeit auf und bietet dabei erstklassigen Widerstand auch bei höchster Beanspruchung sowie ausgezeichnete Geschwindigkeiten auf dem Asphalt. Die Vorteile?

Höhere Produktivität und deutliche Senkung der Betriebskosten bei jeglichem Einsatz.

Geringere Bodenverdichtung

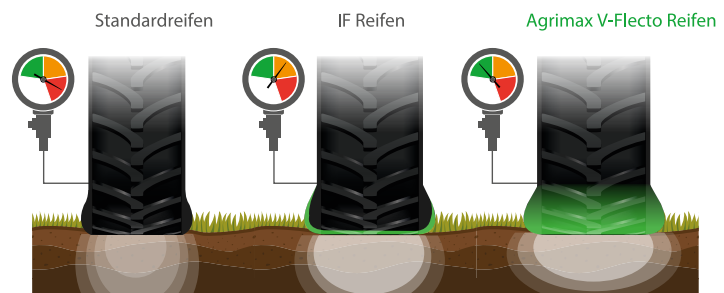

Geringere Betriebskosten



Agrimax V-Flecto wurde speziell für einen langen Lebenszyklus und eine optimale Investitionsrendite entwickelt. Seine Lebenserwartung ist um 10 % höher als die eines vergleichbaren Standardreifens.

Auch beim Einsatz mit niedrigem Druck steht der neue BKT Reifen für Kraft und Stärke sowie hervorragende, dauerhafte Widerstandsfähigkeit, ohne dass damit die Leistung beeinträchtigt wird. Gleichzeitig sind die Gesamtkosten für das Reifenmanagement niedriger.

Höhere Tragkraft

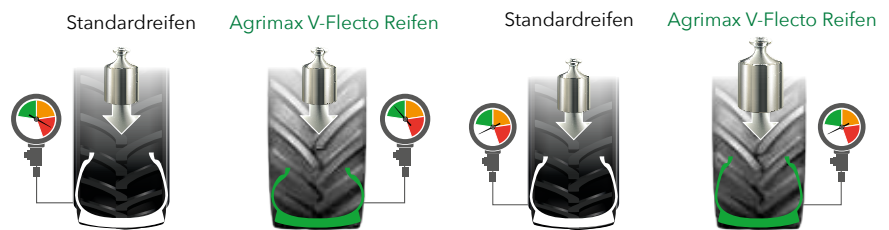

-30% Druck

bei gleicher Last im Vergleich zu einem Standardreifen.

+40% Last

bei gleichem Druck im Vergleich zu einem Standardreifen.

Zuverlässiger Komfort



weniger
Vibrationen



weniger
Lärm

Maximale Leistung



Extrem starke und robuste Struktur

für hohen Ermüdungswiderstand



Bead Protection System

für ein möglichst luftdichtes Aufziehen auf die Felge



Technische Daten

Artikel-Nr.	Größe	Last-/Speed-Index	TL/TT	Felge	Breite in mm	Außen ø in mm	statischer Halbmesser in mm	Abrollumfang in mm	Tragfähigkeit kg	Geschwindigkeit km/h	Luftdruck in bar
157.27.112	VF 480/60 R 28 NRO	145 D	TL	16	470	1290	571	3807	2900	65	1,6
157.27.113	VF 520/60 R 28 NRO	149 D	TL	18	516	1335	587	3910	3250	65	1,6
157.27.106	VF 540/65 R 28	154 D	TL	20/18	539	1413	622	4115	3750	65	1,6
157.27.114	VF 600/60 R 28 NRO	157 D	TL	20/18	587	1440	632	4228	4125	65	1,6
157.27.745	VF 540/65 R 30	158 D	TL	20/18	539	1464	650	4317	4250	65	1,6
157.27.126	VF 600/60 R 30 NRO	158 D	TL	20/18/21	595	1485	649	4377	4250	65	1,6
157.26.788	VF 600/70 R 30 NRO	168 D	TL	21/20	603	1602	702	4764	5600	65	2
157.27.178	VF 540/65 R 38 NRO	162 D	TL	20/18	549	1668	753	4955	4750	65	2
157.27.184	VF 600/60 R 38 NRO	166 D	TL	20/18	587	1685	757	5044	5300	65	2
157.27.198	VF 650/60 R 38	173 D	TL	23/21	650	1745	774	5151	5300	65	1,6
157.27.183	VF 710/55 R 38	175 D	TL	25/24	710	1750	780	5242	6900	65	2,4
157.27.189	VF 650/65 R 38 NRO	169 D	TL	23/21/20	650	1825	798	5387	5800	65	1,6
157.27.196	VF 710/60 R 38 NRO	171 D	TL	25/23	708	1820	794	5395	6150	65	1,6
157.26.958	VF 710/70 R 38	181 D	TL	24/23/25	715	1961	843	5773	8250	65	2
157.27.199	VF 710/75 R 38	183 D	TL	24/23/25	720	2060	905	6151	8750	65	2
157.27.202	VF 580/85 R 42 CFO	183 D	TL	20/18	606	2058	912	6132	8750	65	2,8
157.27.201	VF 650/65 R 42	174 D	TL	23/21	650	1913	852	5698	6700	65	2
157.27.210	VF 710/60 R 42 NRO	173 D	TL	25/23	710	1930	860	5724	6500	65	1,6
157.27.214	VF 710/70 R 42	185 D	TL	24/23/25	720	2061	921	6182	9250	65	2,4
157.27.225	VF 900/60 R 42 NRO	189 D	TL	30	900	2142	931	6425	1030	65	2
157.27.235	VF 750/70 R 44	186 D	TL	25/24	760	2175	985	6450	9500	65	2,4

Bodenschonung und Einsatzoptimierung

Schmalere Felgenbreite dank NRO Technologie

Reifen mit VF-Technologie erfordern normalerweise eine breitere Felge als Standardreifen. Wenn Sie den brandneuen Agrimax V-Flecto von BKT verwenden, müssen Sie keine speziellen Felgen kaufen. BKT setzt Spitzentechnologien ein, um dem Endkunden eine erstklassige Leistung zu bieten.

BKT verwendet die NRO-Technologie, Narrow Rim Option, eine innovative Lösung in Übereinstimmung mit dem kürzlich von der Europäischen Reifen- und Felgen-Sachverständigenorganisation (European Tire and Rim Technical Organization E.T.R.T.O.) eingeführten Test-Standard.

Um zu erfahren, welche Produkte von BKT die "NRO"-Markierung tragen, sollten Sie vor jeder Reifenmontage aufmerksam die technische Produktinformation auf der Internetseite www.bkt-tires.com lesen, und das Auf- und Abmontieren der Reifen ausschließlich erfahrenen Mitarbeitern oder Reifenexperten anvertrauen.

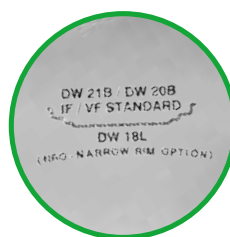



Luftdruckeinstellung anhand von Luftdrucktabellen

Sind die Radbelastung und die maximal zu fahrende Geschwindigkeit für den jeweiligen Reifeneinsatz bekannt, so kann man anhand von entsprechenden Luftdrucktabellen den benötigten Luftdruck ablesen.

Luftdrucktabellen unterscheiden sich nach Reifengrößen sowie Profilen und sind von Hersteller zu Hersteller verschieden. Diese Tabellen sind in den jeweiligen technischen Ratgebern der Hersteller zu finden. Es sollte immer der Ratgeber des Herstellers genutzt werden, dessen Reifen montiert sind, da es Abweichungen bei der Radlast-/Luftdruckkombination der einzelnen Hersteller gibt. Eine allgemeingültige, von Herstellern unabhängige Auflistung gibt es nicht. Der in der Rubrik „Technische Daten“ dieses Ratgebers angegebene Luftdruck entspricht dem Normluftdruck.

Luftdrucktabellen werden ausgehend von der zu fahrenden Geschwindigkeit (1) gelesen. Aus der zur Geschwindigkeit zugehörigen Zeile wird die maximal benötigte Traglast (2) abgelesen, welche innerhalb einer Spalte mit dem zugehörigen Luftdruck (3) steht (Tabelle 1).

Größe	Tragfähigkeit (kg) pro Reifen bei Luftdruck (bar)													
	0,4	0,5	0,6	0,3	1,0	1,2	1,4	1,6	1,7	1,8	1,9	2,1	2,4	km/h
650/65 R 42 (20.8 R 42)	-	2130	2590	2870	3160	3420	3700	3970	4110	4250				50
	-	2130	2590	3010	3420	3840	4250	-	-					40
	1980	2380	2770	3220	3660	4100	4550							30
	2490	2930	3380	3920	4470	5010	5560	6100	6380					

Tabelle 1

Reifendruckregelanlagen bieten eine komfortable Lösung zur häufigen Luftdruckanpassung, z. B. bei wechselndem Transport- und Feldeinsatz in der Gülleausbringung. Eine kostengünstige Alternative, auch als Nachrüstung, stellt der PTG Airbooster dar. Dieses Set kann an die bestehende Druckluftbremsanlage eines Schleppers angeschlossen werden, um die Reifen manuell mit Luft zu füllen bzw. zu entleeren.





Einsatzoptimierung

Wartung und Pflege im Einsatz

Absolute Grundvoraussetzung für ein langes und problemloses Reifenleben ist die richtige Reifenauswahl: Nur wenn diese entsprechend der Empfehlungen des Reifen- und Maschinenherstellers erfolgt, ist die angemessene Wartung und Pflege der Reifen zielführend.

Um die hohe Qualität der Reifen zu bewahren sowie Sicherheit und lange Lebensdauer zu gewährleisten, müssen diese ordnungsgemäß gelagert und gewartet werden. Reifen unterliegen einem Alterungsprozess, der ihre Funktionstüchtigkeit beeinträchtigen kann – unabhängig von der sichtbaren Abnutzung! Reifen, die an überwiegend stehenden Fahrzeugen montiert sind, die sehr selten zum Einsatz kommen bzw. nur gelegentlich auf kurzen Strecken gefahren werden, sind sogar besonders alterungsgefährdet.

Eine Möglichkeit, die Lebensdauer von stark genutzten Reifen zu verlängern, besteht im Nachschneiden des Reifenprofils. Doch dabei ist Vorsicht geboten: Nur wenn der Reifen an der Seitenwand das Wort „Regroovable“ (i.d.R. nur bei LKW Reifen) oder das entsprechende Symbol trägt, ist das Nachschneiden möglich. Die Durchführung ist dabei ausschließlich qualifizierten Fachkräften vorbehalten. Beschädigte Reifen sollten unmittelbar nach Feststellung des Schadens von einem Fachmann repariert werden.

Zugkraft und Reifenverschleiß

Die Zugkraft und die Traktion des Reifens sind entscheidend für einen effektiven und bodenschonenden Geräteeinsatz. Hierbei wird die Traktion maßgeblich von der Verzahnung der Reifen im Boden, der Steigung des Geländes und der Bodenbeschaffenheit beeinflusst. Je besser die Verzahnung, umso geringer ist der Schlupf.



Generell wird von der Industrie ein optimaler Schlupfwert zwischen 10 und 15 % empfohlen. Höhere Werte verursachen hohe Kosten, da die Zerstörung der Bodenstruktur, tiefere Fahrspuren und das Zuschmieren der Pflugsohle das bearbeitete Gelände in Mitleidenschaft ziehen kann. Außerdem steigen Kraftstoff- und Ölverbrauch, die Abnutzung des Motors nimmt zu und die Arbeitszeit auf dem Feld erhöht sich um 10 bis 30 %. Wer also die Gebrauchsdauer der Reifen

auch nach ihrer Abnutzung in die Länge zieht, spart kein Geld, sondern verursacht im Gegenteil vermeidbare Kosten. Der rechtzeitige Austausch abgenutzter Reifen ist in jedem Fall die wirtschaftlichere Entscheidung.

Ab einem Verschleißgrad von 70-80 % sind die abgefahrenen Profilstollen nicht mehr in der Lage, die Motorleistung effizient auf den Boden zu übertragen. In der Folge nimmt die Zugkraft ab und der Schlupf zu. Daher sollte ab diesem Zeitpunkt der Reifen ersetzt werden.



Bodenschonung und Einsatzoptimierung

Einsatzoptimierung bei unruhigem Fahrverhalten

Gelegentlich kommt es vor, dass Kunden nach dem Montieren neuer Reifen oder aber komplett neuer Räder ein unruhiges Laufen des Fahrzeugs beanstanden. Teilweise sprechen sie davon, dass der Schlepper „wie ein Ziegenbock springe“. Reklamiert wird damit in der Regel ein Höhen- oder Seitenschlag. Aufgrund dessen sollten aber keinesfalls sofort die Reifen bzw. Räder ausgetauscht werden. Vorab muss vielmehr unbedingt geprüft werden, ob sich nicht mit einfachen Mitteln die Ursache des Problems ermitteln und beheben lässt.

Hier finden Sie einige wertvolle Tipps und Hinweise, die im Vorfeld einer Reklamation beachtet werden sollten:

Folgende Informationen sollten Sie im ersten Schritt ermitteln und überprüfen:

- Auf welchem Traktor laufen die Reifen (Schleppergröße und KW/PS)?
- Sind die Räder wirklich passend für das Fahrzeug?
- Wird die gleiche Geschwindigkeit gefahren wie vorher oder ist diese erhöht?
- Wie hoch ist der Straßenanteil? Ist dieser seit dem Radwechsel verändert?
- Wie groß ist der Radstand?
- Werden neue Anbaugeräte genutzt (z. B. Frontlader)?
- Wie groß ist der Luftdruck im Verhältnis Vorderachse zu Hinterachse?

Matchen von Rädern zur Verbesserung des Rundlaufs

Jeder Reifen und jede Felge hat einen schweren Punkt und einen leichten Punkt. Bei ungünstigem Sitz des Reifens auf der Felge kann es durch diese nachteilige Montage zu größeren Laufunruhen kommen. Bringt man nun die geometrische Zuordnung von Reifen und Felge in einen besseren Einklang, werden sehr oft hervorragende Ergebnisse erzielt. Empfohlen wird das Drehen des Reifens um 180°.

Bei Verstellfelgen sollte eine Zentrierung vorgenommen werden. Beachten Sie bitte, dass es durch nicht korrektes Verschrauben der Schüssel bei Rädern mit Verstellfelgen zu Laufunruhen kommen kann.

Zur Korrektur des Rundlaufs gehen Sie bitte wie folgt vor:

1. Überprüfen Sie die folgenden Kriterien:

- Reifenalter
- Reifenzustand: optische Begutachtung, insbesondere Bewertung des Abriebsbildes
- Luftdruck: ermitteln, notieren, aber noch nicht korrigieren
- Sitz des Reifens: den Sitz des Reifens auf der Felge auf korrekte Montage hin überprüfen (Wulst-Kennlinie-Felgenhorn)

2. Unternehmen Sie eine Probefahrt:

- Fahren Sie die Reifen „warm“, d. h. bringen Sie sie auf Betriebstemperatur. Dies sorgt für einen gleichförmigeren Reifenlauf. (Bei sogenannten Standplatten laufen die Räder wesentlich unruhiger.)
- Fahren Sie in verschiedenen Geschwindigkeitsbereichen, bewerten Sie dabei den optischen Lauf der Räder. (Achtung: Bei einer gefederten Vorderachse besteht ein höheres „Schluckvermögen“.)
- Achten Sie gezielt auf den Punkt, der beanstandet wird. (Aufschaukeln, Hüpfen, seitliches Einknicken, Vibrationen, usw.)

3. Ergreifen Sie die geeigneten Maßnahmen:

- Korrigieren Sie den Luftdruck.
- Matchen Sie die Räder, indem Sie den Sitz des Reifens auf der Felge wie im Folgenden beschrieben verändern.



Wichtiger Hinweis

Reklamationen

Reichen Sie Reklamationen bitte unbedingt schriftlich ein, mit Angabe der Kaufbelege sowie aller relevanten Reifen- und Schlepperdaten.



398

**Montage von
Landwirtschaftsreifen**

401

Sicherer Radwechsel



MONTAGE VON LANDWIRTSCHAFTSREIFEN

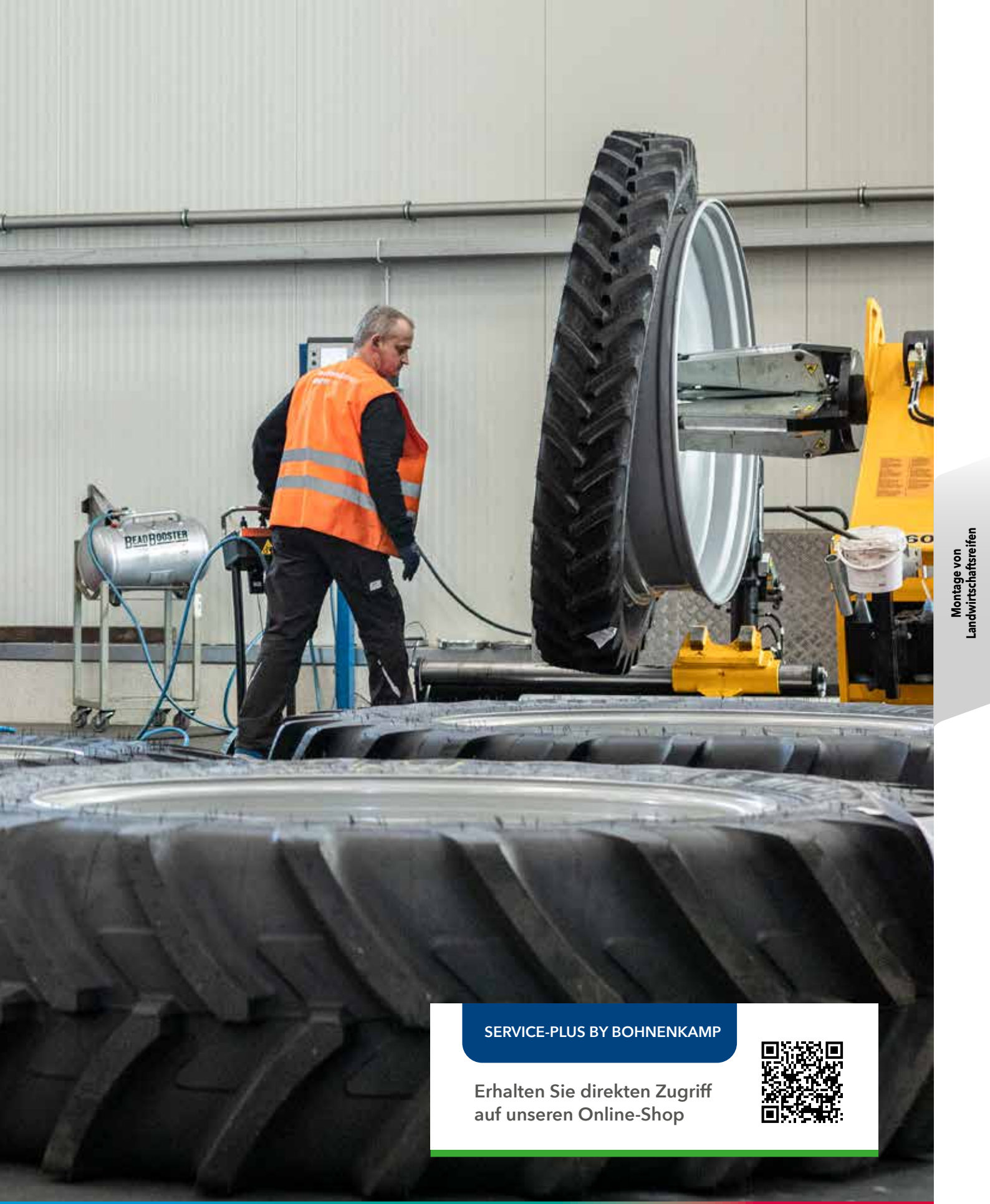

Montage von
Landwirtschaftsreifen

SERVICE-PLUS BY BOHNENKAMP

Erhalten Sie direkten Zugriff
auf unseren Online-Shop





Montage von Landwirtschaftsreifen

Montage von Landwirtschaftsreifen

Die Montage von Landwirtschaftsreifen sollte möglichst behutsam durchgeführt werden. Zudem dürfen nur Felgen verwendet werden, die maßlich einwandfrei, rostfrei und weder beschädigt noch verschlissen sind. Bei mehrteiligen Felgen muss zuvor unbedingt die lose Hornseite geprüft werden. Für neue Reifen sollten stets neue Gummi-Schlauchlosventile oder Dichtungen für Schlauchlos-Metallventile bzw. neue Schläuche und Wulstbänder verwendet werden.

Vor der Montage von neuen Schläuchen sollten diese unbedingt mit Talkum „eingepudert“ werden. Bei großen Reifen ist unbedingt sicherzustellen, dass diese schon bei möglichst geringem Fülldruck am Felgenhorn anliegen.

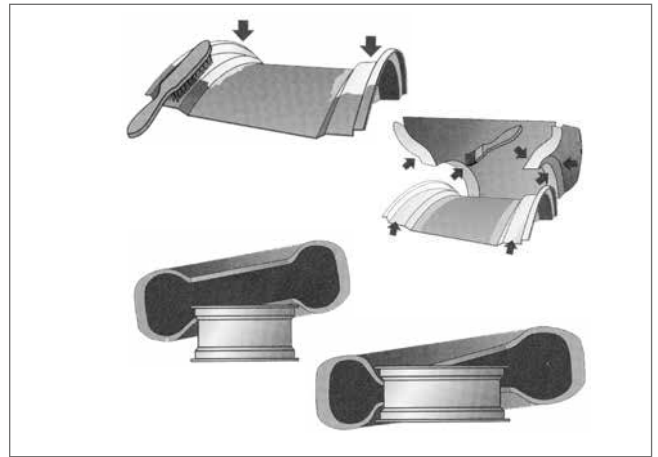

Bei der Montage der Reifen muss darauf geachtet werden, dass die Ventile nach der Montage am Fahrzeug leicht zu erreichen sind. Dieses ist Voraussetzung, um eine laufende Luftdruckwartung durchzuführen. Bei Traktoren mit Allradantrieb muss beachtet werden, dass die Reifengrößen von Vorder- und Hinterachse mit der mechanischen Übersetzung des Traktors bzw. der Voreilung der Vorderachse vereinbar sind (siehe Kapitel Vorlauf und Übersetzungsverhältnis).

Reifen zweier unterschiedlicher Bauarten dürfen weder bei Einfach- noch bei Zwillingsbereifung auf einer Achse montiert werden. Für einen neuen Tube-Type-Reifen muss auch ein neuer Schlauch verwendet werden, da selbst ein äußerlich einwandfreier Schlauch durch längere Laufzeit beschädigt sein kann.

Laufriichtung

Die Laufriichtung von Ackerschleppertreibradreifen ist auf den Seitenwänden der Reifen mit einem Pfeil angegeben. Diese Empfehlung bezieht sich auf den Einsatz von Treibradreifen auf angetriebenen Achsen.

Ackerschlepperreifen erzielen die besten Ergebnisse hinsichtlich Selbstreinigung, Traktion und Seitenführung am Hang, wenn sie entsprechend der Laufriichtungsempfehlung montiert sind. Bei der Montage von AS-Reifen an nicht angetriebenen Achsen, beispielsweise von Anhängern oder Mähdrescherhinterachsen und Feldspritzen, besteht die Möglichkeit, die Reifen entgegen der Richtung des Laufriichtungspfeils zu montieren. Da der Reifen in diesem Fall „geschleppt“ wird, wirkt der auftretende Schlupf hier – anders als bei Treibachsen – entgegengesetzt.



Montage und Demontage von Reifen

Sowohl die Montage als auch die Demontage von Reifen sollte ausschließlich geschultem Fachpersonal überlassen werden. Nur mit entsprechender Erfahrung und geeignetem Werkzeug können große Gefahren bei der Montage vermieden werden.

Wichtig ist die Verwendung einer Luftzufuhr mit Druckkontrolle. Die Folgen falscher Montagen können dazu führen, dass der Reifen falsch auf der Felge sitzt und der Reifen im Extremfall platzen kann. Schwerwiegende oder sogar tödliche Verletzungen können die Folge sein.

Bei der Demontage des Reifens gilt es folgendes zu beachten:

1. Einen Reifen in aufgepumpten Zustand niemals versuchen von der Felge herunter zu drücken
2. Immer darauf achten, dass der Ventilkörper entfernt wird
3. Luft ablassen
 - Vor der Demontage unbedingt prüfen, ob sämtliche Luft aus dem Reifen entwichen ist
 - Passendes Werkzeug verwenden, um Beschädigungen an der Felge oder der Reifenwulst zu vermeiden

Egal, welche Arbeiten an der Felge oder am Reifen vorgenommen werden, es ist immer notwendig, Reifen und Felge ordnungsgemäß voneinander zu trennen.

Montageluftdruck

Der Montageluftdruck ist der Luftdruck, mit dem der Reifen bei der Montage befüllt wird, damit der Reifen optimal auf der Felge sitzt. Dieses wird auch als „setzen des Reifens“ bezeichnet. Um diesen zu erreichen ist teilweise ein höherer Luftdruck als im normalen Fahreinsatz erforderlich. Aber auch für diesen Luftdruck gibt es Grenzen. Bei Landwirtschaftsreifen darf er 150 % des max. Normluftdrucks nicht überschreiten und keinesfalls größer als 2,5 bar sein.

Bei MPT-Reifen darf ein Wert von 10,0 bar nicht überschritten werden. Bei EM-Reifen darf der Montageluftdruck den max. Normluftdruck für 50 km/h nicht überschreiten.



Wichtiger Hinweis



Das Piktogramm „Explosionsgefahr“ befindet sich auf jeder Seite des Reifens!

Auf fast allen AS-Reifen steht: „Warning - Never exceed 35 PSI in seating Beads“.

Dieser Hinweis bedeutet, dass die Bereifung auch bei der Montage niemals über 2,5 bar (35 PSI) aufgepumpt werden darf. Wenn bei 2,5 bar die Reifenwülste nicht richtig sitzen, muss die Luft wieder abgelassen werden. Die Wülste sollten jetzt abgedrückt und der Reifensitz korrigiert werden.

Anschließend muss nochmals geschmiert und erst dann wieder aufgepumpt werden. Nachdem der korrekte Sitz der Wülste hergestellt wurde, darf der vorgeschriebene Reifendruck eingestellt werden.

Bitte auf keinen Fall versuchen, die Wülste durch einen höheren Luftdruck in die richtige Lage zu bringen. Ein Luftdruck von mehr als 2,5 bar kann den Reifenwulst oder sogar die Felge mit explosiver Gewalt zerreißen – ein Ereignis, das schwere und im Extremfall tödliche Verletzungen verursachen kann!



Montage von Landwirtschaftsreifen

Auswahl der passenden Felge

Grundsätzlich gilt: Montieren Sie einen Reifen immer auf eine vom Hersteller freigegebene Felge! Die Montage auf einem falschen Felgendurchmesser kann zu ernsthaften Verletzungen während der Montage führen sowie zu einem Erlöschen der Betriebserlaubnis führen.

Angaben zur richtigen Felgengröße finden Sie in den technischen Daten des Herstellers. Diese müssen vor jeder Montage unbedingt geprüft werden. (Abb. 1)

Reifen-größe	Profil-bezeichnung	Empfohlene und zugelassene Felgen	Breite in mm	Außen Ø in mm
540/65 R38	Agrimax RT 657	16, 18	530	1667
VF 540/65 R38 NRO	Agrimax V-FLECTO	20, 18	549	1668
600/65 R38	Agrimax RT 657	20, 18	611	1745
650/65 R38	Agrimax RT 657	20, 18	645	1811
VF 650/65 R38 NRO	Agrimax V-FLECTO	23, 20/21	650	1825
710/70R38	Agrimax RT 765	23	716	1959

Abbildung 1 Informationen zu freigegebenen Felgen
Die empfohlene Felge ist in der Regel fett gedruckt.

Je nachdem, welche der freigegebenen Felgen Sie auswählen, kommt es zu Veränderungen im Fahrverhalten des Traktors. Durch die Montage auf einer breiteren oder schmaleren Felge lassen sich folgende Veränderungen erzielen:

Verwendung breiterer Felgen

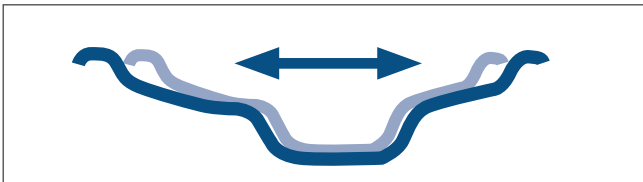

- Abflachung des Reifenprofils
- verbesserte Traktion auf lockeren Böden
- verminderte Traktion auf härteren Böden
- zusätzliche Belastung auf der Reifenschulter
- intensivere Abnutzung der Reifenschulter
- weniger flexible Seitenwand – die Karkasse bricht und/oder löst sich ab

Verwendung schmalere Felgen

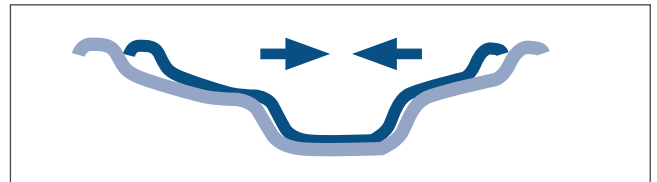

- Lauffläche des Reifens wird abgerundet
- weniger Traktion auf dem Feld
- mögliche Montageprobleme
- mögliche Ablösung der Seitenwand
- starke Abnutzung in der Mitte der Lauffläche

Bei einem Fehler in der Montage kann es zum sogenannten „Felgenschlupf“ kommen. Dieses bezeichnet das Drehen des Reifens auf der Felge.

Mögliche Ursachen hierfür können sein:

- zu niedriger Luftdruck
- inkorrekt sitzender Reifenwulst auf der Felge
- ungeeignete Montagepaste
- ungeeigneter Reifen für das hohe Drehmoment
- zu kleine Felge

Sollte es zu einem Drehen auf der Felge kommen, sollte zuerst der Luftdruck und die verwendete Felgengröße mit dem Handbuch des Reifenherstellers verglichen werden. Entsprechen beiden den Vorgaben, sollte der Reifen demontiert und neu aufgezogen werden. Besteht das Problem dennoch weiter, kontaktieren Sie gerne unsere Experten oder ggf. auch den Hersteller des Schleppers.



Die Lösung für den sicheren und schnellen Radwechsel

Die Radhebewechselwagen Liberator und Liberator XL von Gothia Redskamp erfüllen die höchsten Qualitätsansprüche. Sie ermöglichen das Wechseln von Rädern bis zu 1.200 mm Breite und 1.200 kg durch nur eine Person.

Mithilfe des Pumpehebels wird das Rad einfach in die exakte Montagehöhe gehoben und mit 8 Laufrollen leicht in der passenden Montageposition fixiert. Die Radhalterung wurde diagonal konstruiert, um einen guten Zugang beim Öffnen der Radmutter zu ermöglichen.

Das Rad ist bei der Montage und Demontage gegen Umfallen gesichert und schützt den Mitarbeiter vor körperlichen Schäden wie Überlastung und Verletzungen.



Die Vorteile

- Zeitsparender und sicherer Radwechsel
- Für Räder jeder Größe und jedes Gewichts
- Von einer Person zu bedienen
- Erstklassige Qualität aus Schweden

Liberator XL



Technische Daten

Max. Ladekapazität:	1.200 kg
Min. Radgröße:	1100 mm
Max. Radgröße:	2200 mm
Max. Reifenbreite:	1200 mm
Gewicht:	123 kg
Breite zusammengeklappt:	1260 mm
Tiefe zusammengeklappt:	1060 mm
Laufräder:	150 x 40 mm

Liberator



Technische Daten

Max. Ladekapazität:	1.200 kg
Min. Radgröße:	1300 mm
Max. Radgröße:	2000 mm
Max. Reifenbreite:	800 mm
Gewicht:	112 kg
Breite zusammengeklappt:	1260 mm
Tiefe zusammengeklappt:	1060 mm
Laufräder:	150 x 40 mm

404

Umbereifung und Vorlaufverhältnis

406

Voreilung

408

Umrüsttabellen Traktoren

- Umrüsttabelle AS-Bereifung
- Umrüsttabelle Kleinreifen
- Umrüsttabelle Industrie- /Staplerreifen

420

Ballastierung von Rädern

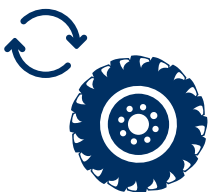

UMBEREIFUN UND BALLASTIERUNG

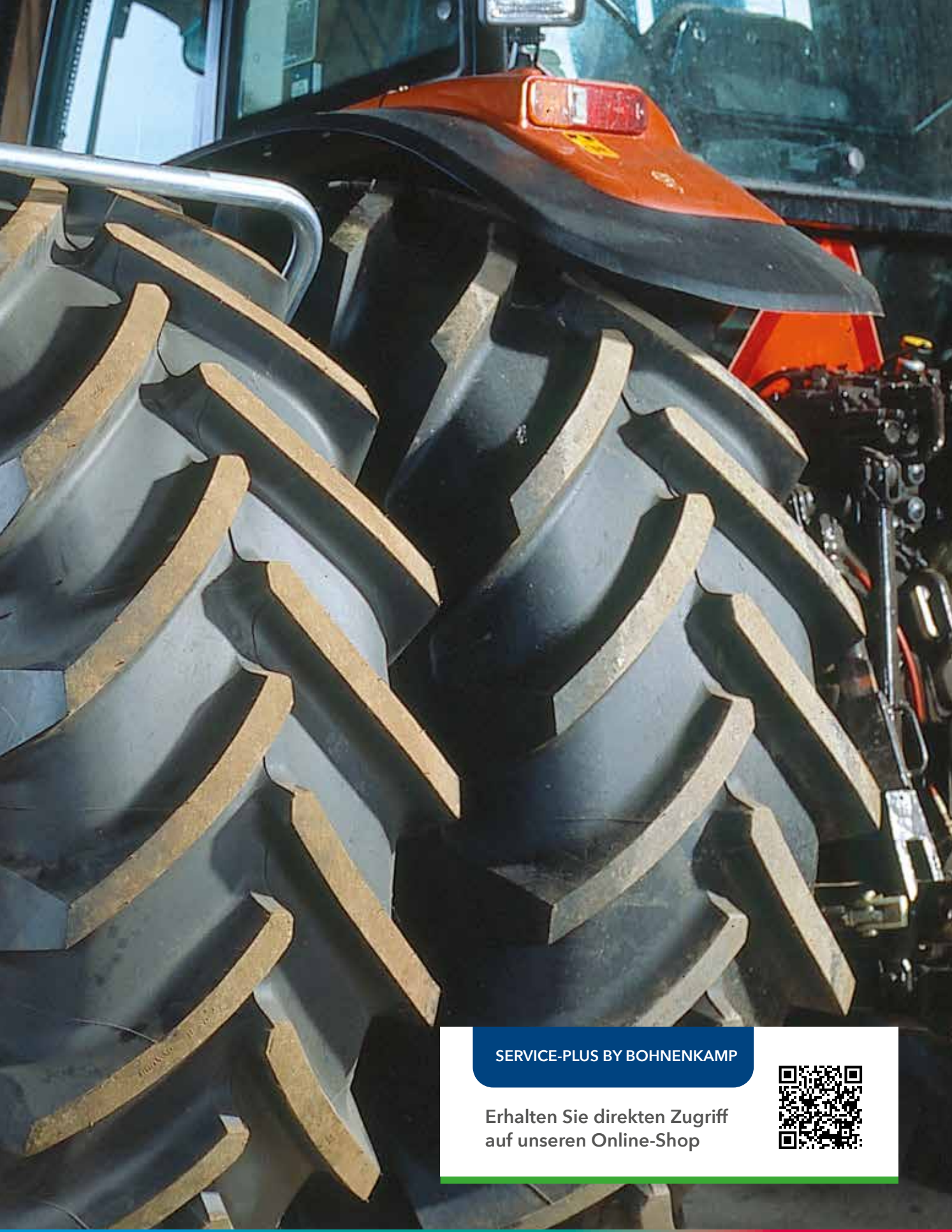

SERVICE-PLUS BY BOHNENKAMP

Erhalten Sie direkten Zugriff
auf unseren Online-Shop



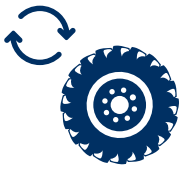

Umbereifung und Vorlaufverhältnis

Umbereifung

Soll die Umbereifung von Schleppern oder anderen landwirtschaftlichen Geräten, beispielsweise auf Pflege- oder Kommunalreifen bzw. eine Zwillingsbereifung vorgenommen werden, müssen bestimmte Voraussetzungen erfüllt werden: Wenn das Fahrzeug auch auf öffentlichen Straßen unterwegs ist, muss es den Bestimmungen der StVZO entsprechen. Nicht im Fahrzeugschein eingetragene Reifengrößen sind unbedingt nachzutragen. Eine Unbedenklichkeitsbescheinigung des Fahrzeugherstellers dient dabei als Einverständnis zur Eintragung bei der technischen Überwachung.

Für Allrad Schlepper mit verschiedenen Reifendimensionen vorne und hinten ist das Drehzahlverhältnis zwischen Vorder- und Hinterachse benannt. Dieses Drehzahlverhältnis wird vom Fahrzeughersteller in Abhängigkeit von den mechanischen Daten des Fahrzeugs und der vorgesehenen Reifenausrüstung festgelegt. In den meisten Fällen hat die Vorderachse des Schleppers einen

Vorlauf, d. h. die Vorderräder laufen ca. 2 bis 4 % schneller als die Hinterräder.

Bei der Änderung der Reifenausstattung einer der beiden Achsen sollte eine vom Ursprung abweichende Reifendimension nur dann verwendet werden, wenn das Verhältnis der Abrollumfänge von Vorderachse zu Hinterachse in dem vom Fahrzeughersteller vorgesehenen Toleranzrahmen bleibt. Beim Umrüsten des Fahrzeugs auf Breitreifen- bzw. Breiträder oder andere Serien muss der Vorlauf kontrolliert werden!



Wichtiger Hinweis

Reifenauswahl

Die Frage, welcher Reifen der richtige für das jeweilige Fahrzeug ist, muss daher sorgfältig geklärt werden. Hierfür stehen Ihnen die Fachberater von

Bohnenkamp gerne zur Verfügung.

Hierzu zwei einfache, aber wichtige Empfehlungen:

- Montieren Sie nur Reifen, die ausdrücklich vom Fahrzeughersteller freigegeben worden sind. Andernfalls kann der Verlust der Gewährleistung drohen.
- Achten Sie auf die Freigängigkeit der Reifen am Fahrzeug, um eine maximale Sicherheit im Fahrbetrieb zu gewährleisten.



Expertenwissen kompakt

Beim Allrad Schlepper laufen die Vorderräder mit einer höheren Drehzahl, um den gleichen Weg wie die „größeren“ Hinterräder zurücklegen zu können. Jeder Schlepperhersteller legt ein Übersetzungsverhältnis fest.

Das Übersetzungsverhältnis gibt die Anzahl der Umdrehungen der Vorderräder für eine Umdrehung der Hinterräder an.

Vorlauf- und Übersetzungsverhältnis

Um einen optimalen Vierradantrieb zu erreichen, müssten sich alle vier Räder des Ackerschleppers mit gleicher Umfangsgeschwindigkeit drehen. Ein exakter Synchronlauf ist jedoch nicht möglich, weil ja die Reifen an Vorder- und Hinterachse nicht gleich groß sind und damit die Abrollumfänge nicht übereinstimmen. Außerdem verändern Verschleiß, Belastung und Luftdruck die Abrollumfänge während des Einsatzes. Die richtige Bereifung muss also so ausgelegt werden, dass im Fahrbetrieb beide Achsen in allen möglichen Betriebszuständen in die gleiche Richtung ziehen.

Dies erreicht man dadurch, dass für die Vorderachse ein Reifen ausgewählt wird, der – im Verhältnis zum Synchronverhältnis – einen etwas größeren Abrollumfang hat. Im Fahrbetrieb ist deshalb die Vorwärtsgeschwindigkeit beider Achsen gleich, aber durch die größeren Reifen auf der Vorderachse läuft diese schneller. Diese Tatsache wird als Vorlauf oder Voreilung bezeichnet. Vorlauf ist die Differenz zwischen theoretischer und effektiver Fahrgeschwindigkeit der Vorderachse, sie wird in Prozent angegeben.

Im dynamischen Zustand - also während des Fahrens - wird der beste Wirkungsgrad des Traktors bei einer Voreilung von zwei bis drei Prozent erreicht. Wie schon erwähnt, verändert sich die Voreilung im Laufe der Einsatzdauer einer Reifengarnitur oder unter bestimmten Einsatzverhältnissen.

Wird zum Beispiel nur ein Satz neuer Hinterreifen montiert, kann die Voreilung von drei Prozent auf null Prozent absinken. Umgekehrt: Neue Front- und alte Heckbereifung lässt die Voreilung auf sechs Prozent steigen. Ähnliches gilt für den Luftdruck: 0,6 bar vorn und 1,9 bar hinten ergeben zwei Prozent, 1,9 bar vorn und 0,6 bar hinten ergeben sieben Prozent Voreilung.

Übersetzungsverhältnis $i = \frac{1,298}{1} = 1,298$

Bei 1000 Umdrehungen des Hinterrades würde bei diesem Beispiel das Vorderrad 298 Umdrehungen mehr machen. Dies entspricht bei 2000 Betriebsstunden über eine Millionen Umdrehungen!

Nachteile eines zu hohen Vorlaufs:

- höherer Dieselverbrauch
- zusätzlicher Reifenverschleiß
- Verschleiß im Antriebsstrang
- Leistungsverluste des Antriebsmotors
- schlechteres Ein- und Ausschalten des Allradantriebs
- Schlupfschäden im Ackerboden

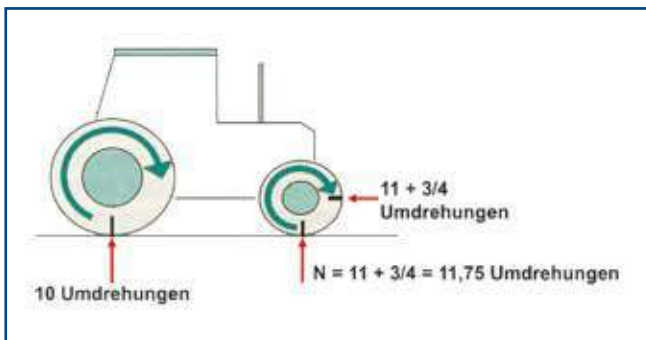

Bestimmung der Allradkonstante 3/4 Umdrehung

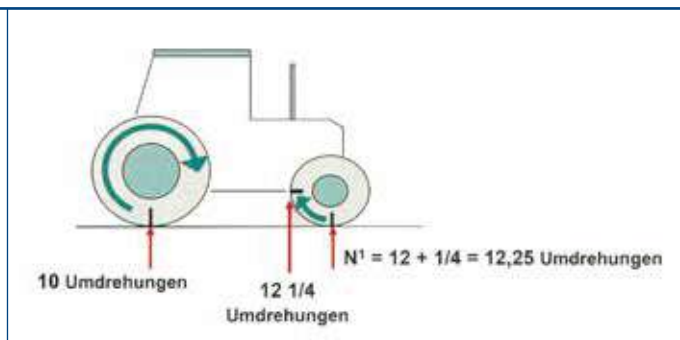

Bestimmung der Allradkonstante 1/4 Umdrehung

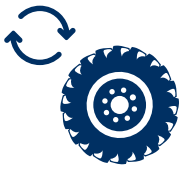

Umbereifung und Ballastierung

Festlegung der Vorderradbereifung in Abhängigkeit der Hinterradbereifung

Beispiel:

Schlepper mit Übersetzungsverhältnis von $i = 1,325$

Hinterradbereifung: 650/65 R 38 BKT

Abrollumfang 5563 mm

Rechnung:

$$\text{Abrollumfang vorne} = \frac{5563}{1,325} = 4199$$

minimaler Abrollumfang	(0%)	=	4199 mm
maximaler Abrollumfang	(+4%)	=	4366 mm
optimaler Abrollumfang	(+2%)	=	4283 mm
bzw.	(+3%)	=	4324 mm

Ergebnis:

Es muss ein Reifen ausgesucht werden, dessen Abrollumfang zwischen 4199 mm und 4324 mm liegt, optimal wäre ein Abrollumfang zwischen 4283 mm und 4324 mm.

Lösung (für dieses Beispiel):

Reifen 540/65 R 28 BKT mit einem Abrollumfang von 4311 mm

$$\text{Abrollumfang vorne} = \frac{\text{Abrollumfang hinten}}{i = \text{Übersetzungsverhältnis}}$$

Hinweis:

Eine nicht korrekte Voreilung

- erhöht den Kraftstoffverbrauch
- beschleunigt den Reifenverschleiß auf Vorder- und Hinterachse
- führt zu vorzeitiger Abnutzung im Antriebsstrang
- verringert die Fahrgeschwindigkeit des Traktors bei bestimmten Arbeiten (z.B. Pflügen)

und bewirkt

- Rucken oder Schläge beim Zuschalten der Vorderachse
- Leistungsverluste beim Traktor
- Schänden an der Bodenoberfläche

Berechnung der Voreilung:

$$\frac{\text{Abrollumfang Vorderreifen} \times R^* - \text{Abrollumfang Hinterreifen}}{\text{Abrollumfang Hinterreifen}} \times 100\% = \text{Voreilung in \%}$$

* R = Allradkonstante/Übersetzungsverhältnis, dass immer vom Fahrzeughersteller festgelegt wird!



Wichtiger Hinweis

Der Vorlauf ist das Geschwindigkeitsverhältnis zwischen Vorderrad und Hinterrad in %

- Der beste Wirkungsgrad eines Schleppers ist dann gegeben, wenn die Vorderräder etwa 2-3 % schneller laufen als die Hinterräder. Dieser Wert von 2-3 % wird als Vorlauf oder Voreilung bezeichnet.
- Unter normalen Voraussetzungen, d.h. kleinere Vorder- als Hinterräder, muss der Vorlauf mindestens 0 % betragen und darf maximal 5% nicht überschreiten

Dynamische Messung der Voreilung:

1. VA zuschalten, Differenzial blockieren
2. Markierungen an den Stellen des Reifens mit Bodenkontakt anbringen
3. Mit dem Fahrzeug 10 HA-Radumdrehungen nach vorne fahren
4. Zählen der VA-Radumdrehungen
5. Berechnung: $\text{Radumdrehungen VA} / \text{Radumdrehungen HA} = i_{\text{ges}}$ (Allradkonstante)

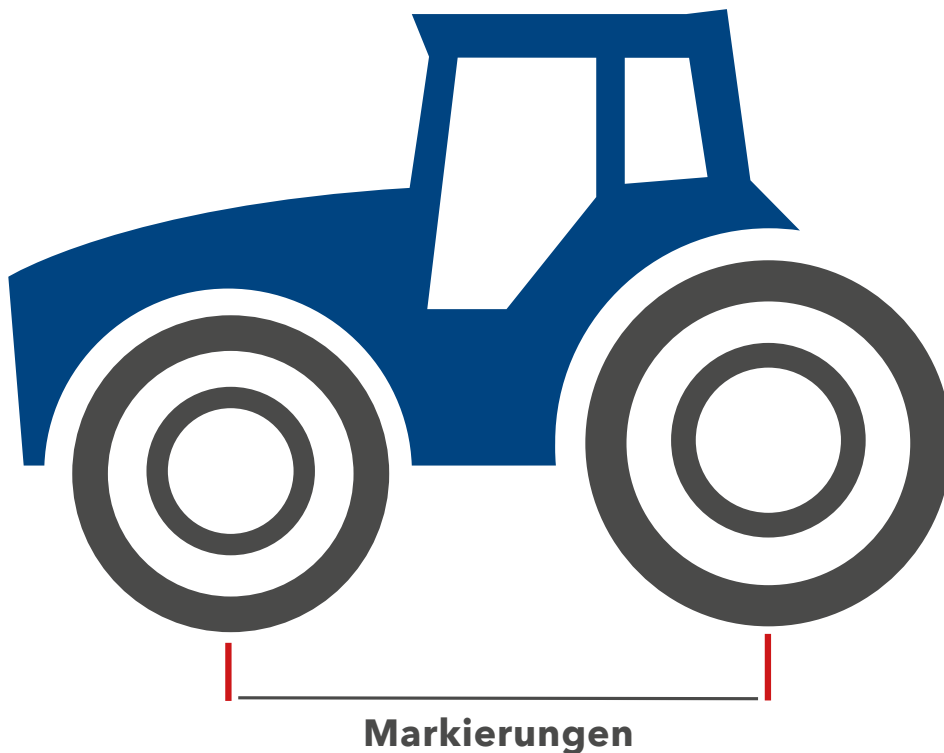

**Wichtiger
Hinweis**

**Auf der Straße muss der Allradantrieb
immer ausgeschaltet sein!**

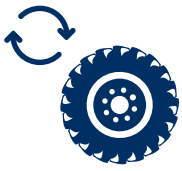

Umbereifung Umrüstattabelle AS-Bereifung

Höhe in mm	Standardreifen		Serie 70	Breitreifen Serie 65	Sonderbreiten auf Messfelge
	Zoll	Metrisch			
760-780	6.50 - 16	180/95 R 16	260/70 R 16		
792-844	7.50 R 16	250/80 - 16	280/70 R 16		
773-790	10 R 16.5				
821-865	12 R 16.5				
849-875	7.50 R 18	250/80 - 18	280/70 R 18	320/65 R 18	11 LR 16
899-920	10.5 R 18	280/80 R 18	325/70 R 18	340/65 R 18	
978-1001	12.5 R 18	335/80 R 18 340/80 R 18	365/70 R 18		
987-1002	12.5/80 R 18				
1021-1025	16.0/70 R 18				
890-918	7.50 R 20	250/80 R 20	280/70 R 20		400/55 - 17.5 280/80 R 18 325/70 R 18 340/65 R 18
937-960	9.5 R 20	250/85 R 20	300/70 R 20	340/65 R 20	
950-1010	10.5 R 20	275/80 R 20 280/80 R 20	320/70 R 20		365/70 R 18
975-1010	11.2 R 20	280/85 R 20	320/70 R 20		365/70 R 18
1036-1064	12.4 R 20	320/85 R 20	360/70 R 20	420/65 R 20	
1030-1068	12.5 R 20	335/80 R 20 340/80 R 20	375/70 R 20	420/65 R 20	340/75 R 20
1058-1102	14.5 R 20	375/75 R 20	400/70 R 20 405/70 R 20		375/75 R 20 380/75 R 20
1058-1082	16.0/70 R 20				
975-1010	8.3 R 24	220/85 R 24 210/90 R 24			365/70 R 18 320/70 R 20
1032-1068	9.5 R 24	250/85 R 24	300/70 R 24		320/85 R 20 335/80 R 20 340/75 R 20 360/70 R 20 420/65 R 20

Technische Änderungen / Abweichungen / Ergänzungen vorbehalten

	Pfl gereifen		Kommunalreifen 65/70/80er Serie
	Zoll	Metrisch	
		180/95 R 16	260/70 R 16 315/55 R 16
	7.50 //	210/95 R 16	250/80 R 16 280/70 R 16
			265/70 R 16.5 305/70 R 16.5
	7.50 //	210/95 R 18	280/70 R 18
			340/80 R 18 340/80 R 18 405/70 R 18
	8.3 //	210/90 R 20 8.3 // 210/95 R 20	
	9.5 //	250/85 R 20	300/70 R 20
	8.3 //	210/90 R 24	320/70 R 20
	8.3 //	210/90 R 24	
	9.5 //	250/85 R 24	
	9.5 //	250/85 R 24	340/80 R 20
	11.2 //	280/85 R 24	360/80 R 20 400/70 R 20
			400/70 R 20 405/70 R 20

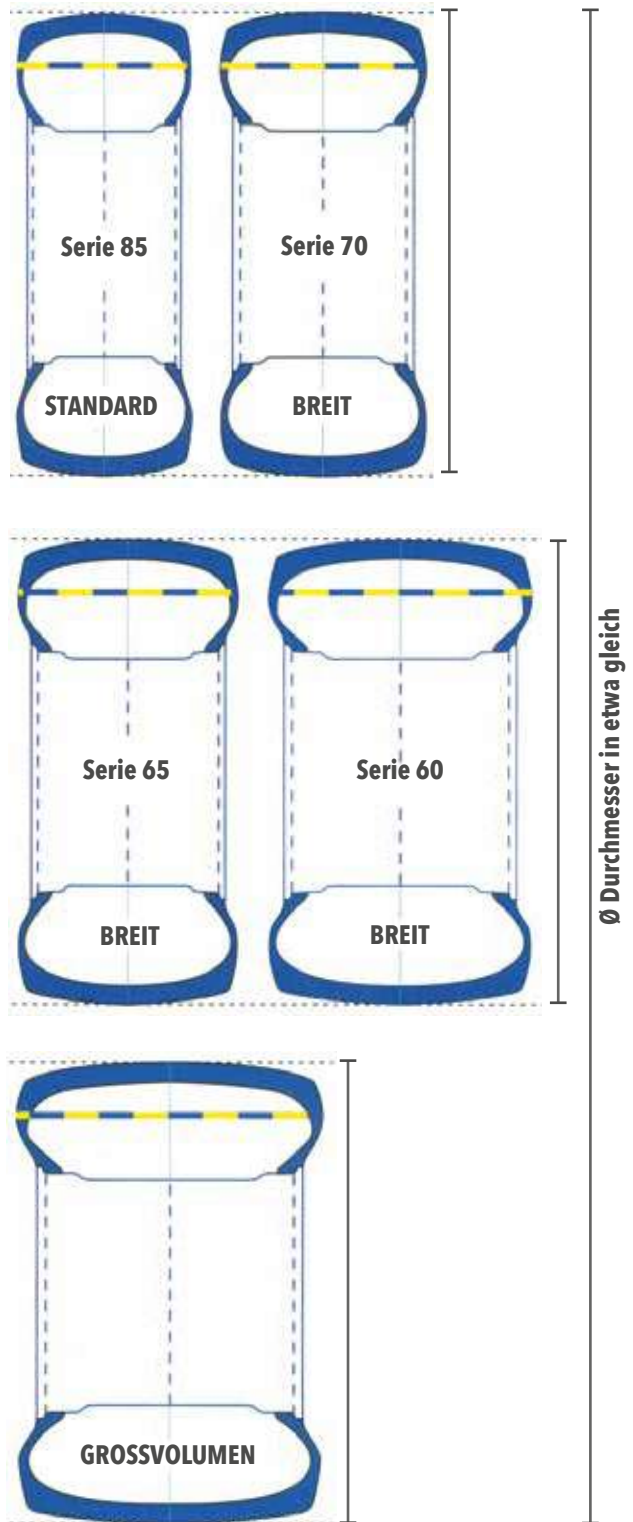

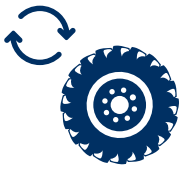

Umbereifung Umrüstattabelle AS-Bereifung

Höhe in mm	Standardreifen		Serie 70	Breitreifen Serie 65	Sonderbreiten auf Messfelge
	Zoll	Metrisch			
1082-1115	11.2 R 24	280/85 R 24	320/70 R 24		375/75 R 20 (14.9 LR 20) 380/70 R 20 380/75 R 20 400/70 R 20 405/70 R 20
1138-1223	12.4 R 24	320/85 R 24	360/70 R 24	420/65 R 24	425/75 R 20 600/50 - 22.5 400/70 R 24 405/70 R 24 400/60 - 26.5
1181-1220	13.6 R 24	340/85 R 24	380/70 R 24	440/65 R 24	
1225-1266	14.9 R 24	380/85 R 24	420/70 R 24	480/65 R 24	445/70 R 24 460/70 R 24 (17.5 LR 24)
1283-1345	16.9 R 24	420/85 R 24	480/70 R 24	540/65 R 24	495/70 R 24 500/70 R 24 (19.5 LR 24) 600/55 - 26.5 700/50 - 26.5 440/65 R 28
1290-1345	14.9 R 26	380/85 R 26			500/70 R 24 (19.5 LR 24) 540/65 R 24 380/70 R 28
1345-1384	16.9 R 26	420/85 R 26	480/70 R 26	540/65 R 26	
1400-1467	18.4 R 26	460/85 R 26	520/70 R 26		520/80 R 26 580/70 R 26 480/70 R 28 540/65 R 28
1550-1646	23.1 - 26	620/75 R 26			600/70 R 30 710/60 R 30
1542-1646	28 LR 26			750/65 R 26	600/70 R 30 710/60 R 30
1094-1115	8.3 R 28				320/70 R 24
1137-1154	9.5 R 28	250/85 R 28			360/70 R 24
1182-1220	11.2 R 28	280/85 R 28	320/70 R 28		380/70 R 24 405/70 R 24 440/65 R 24
1225-1266	12.4 R 28	320/85 R 28	360/70 R 28	420/65 R 28	460/70 R 24 (17.5 LR 24)

	Pflegereifen		Kommunalreifen 65/70/80er Serie
	Zoll	Metrisch	
	8.3	// 210/95 R 28	300/80 R 24
	9.5	// 250/85 R 28	340/80 R 24
	8.3	// 210/95 R 32	360/70 R 24 420/65 R 24
	11.2	// 280/85 R 28	360/80 R 24
	8.3	// 210/95 R 32	380/70 R 24 460/65 R 24
	12.4	// 320/85 R 28	400/80 R 24
	9.5	// 230/95 R 32	420/70 R 24
	11.2	// 270/80 R 32	460/70 R 24 (17.5 LR 24) 480/65 R 24
	11.2	// 270/95 R 32	440/80 R 24
	8.3	// 210/95 R 36	500/70 R 24 (19.5 LR 24) 540/65 R 24
	11.2	// 270/95 R 32	500/70 R 24 (19.5 LR 24)
	8.3	// 210/95 R 36	
	9.5	// 230/95 R 36	
	12.4	// 320/85 R 32	
	11.2	// 270/95 R 36	480/80 R 26
	12.4	// 320/85 R 34	
	9.5	// 230/95 R 44	
	11.2	// 270/95 R 42	
	8.3	// 210/95 R 28	300/80 R 34
	9.5	// 250/85 R 28	
	11.2	// 280/85 R 28	
	9.5	// 230/95 R 32	320/85 R 28
	11,2	// 270/80 R 32	

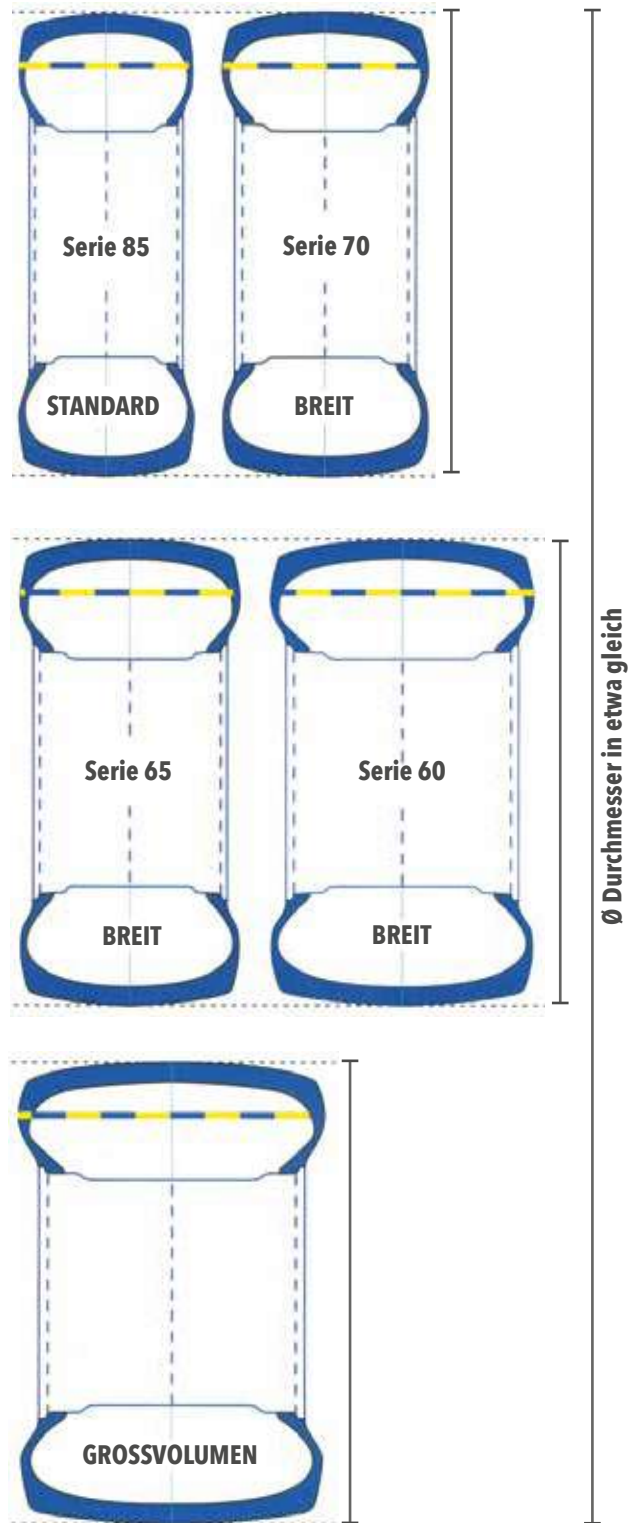

Umbereifung und
Ballastierung

Technische Änderungen / Abweichungen / Ergänzungen vorbehalten

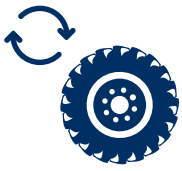

Umbereifung Umrüstattabelle AS-Bereifung

Höhe in mm	Standardreifen		Serie 70	Breitreifen Serie 65	Sonderbreiten auf Messfelge
	Zoll	Metrisch			
1283-1345	13.6 R 28	340/85 R 28	380/70 R 28	440/65 R 28	480/60 R 28 480/70 R 24 495/70 R 24 500/70 R 24 (19.5 LR 24) 600/55 - 26.5
1335-1366	14.9 R 28	380/85 R 28	420/70 R 28	480/65 R 28	480/65 R 28 520/60 R 28
1391-1450	16.9 R 28	420/85 R 28	480/70 R 28	540/65 R 28	480/80 R 26 580/70 R 26 420/85 R 28 540/65 R 28 600/60 R 28
1391-1450	14.9 R 30	380/85 R 30	420/70 R 30		580/70 R 26 420/85 R 28 480/70 R 28 540/65 R 28
1446-1503	16.9 R 30	420/85 R 30	480/70 R 30	540/65 R 30	620/70 R 26 600/65 R 28 540/65 R 30 600/60 R 30 600/60 - 30.5
1495-1636	18.4 R 30	460/85 R 30	520/70 R 30	600/65 R 30	620/75 R 26 750/65 R 26 600/65 R 30 600/70 R 28 710/55 R 30
1660-1721	23.1 R 30		620/75 R 30		1000/50 R 25 650/75 R 30
1290-1366	12.4 R 32	320/85 R 32			420/70 R 28 480/65 R 28
1789-1825	24.5 R 32		650/75 R 32		
1820-1865	30.5 LR 32			800/65 R 32	680/75 R 32 800/65 R 32
1350-1550	14.9 R 34	380/85 R 34			460/85 R 30
1543-1646	16.9 R 34	420/85 R 34	480/70 R 34	540/65 R 34	620/75 R 26 750/65 R 26 600/70 R 30 710/60 R 30 750/55 R 30 540/65 R 34

Technische Änderungen / Abweichungen / Ergänzungen vorbehalten

	Pfl gereifen		Kommunalreifen 65/70/80er Serie
	Zoll	Metrisch	
	11.2 //	270/95 R 32	360/80 R 28
	8.3 //	210/95 R 36	
	12.4 //	320/85 R 32	400/80 R 28
	9.5 //	230/95 R 36	480/65 R 28
	9.5 //	270/80 R 36	
		320/90 R 32	440/80 R 28
		290/95 R 34	540/65 R 28
	12.4 //	320/85 R 34	
	11.2 //	270/95 R 36	
		320/90 R 32	
		290/95 R 34	
	12.4 //	320/85 R 34	
	11.2 //	270/95 R 36	
		320/90 R 32	
		290/95 R 34	
	12.4 //	320/85 R 34	
	11.2 //	270/95 R 36	
	12.4 //	320/85 R 36	440/80 R 30
	11.2 //	270/95 R 38	540/65 R 30
	9.5 //	230/95 R 40	
	12.4 //	320/85 R 38	
	9.5 //	230/95 R 42	
	8.3 //	210/95 R 44	480/80 R 30
	8.3 //	210/95 R 36	
	11.2 //	270/80 R 36	
	12.4 //	320/85 R 36	
	9.5 //	230/95 R 42	
	13.6 //	340/85 R 38	
	11.2 //	270/95 R 42	
	11.2 //	300/85 R 42	
	9.5 //	230/95 R 44	440/80 R 34

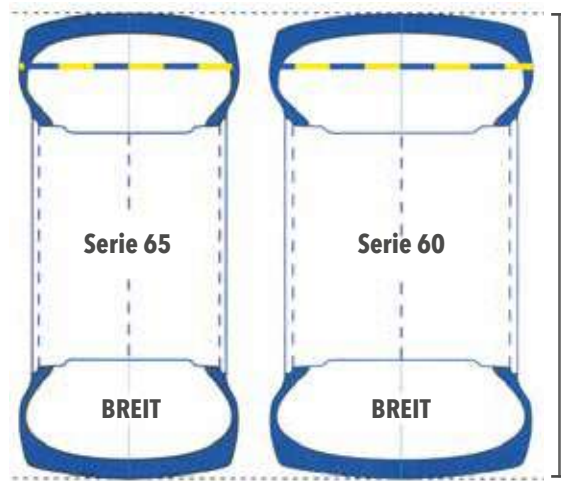
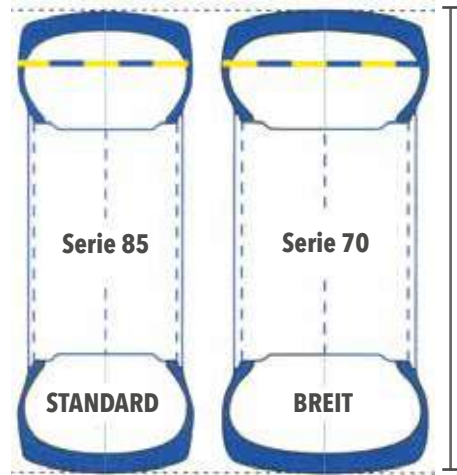

Ø Durchmesser in etwa gleich

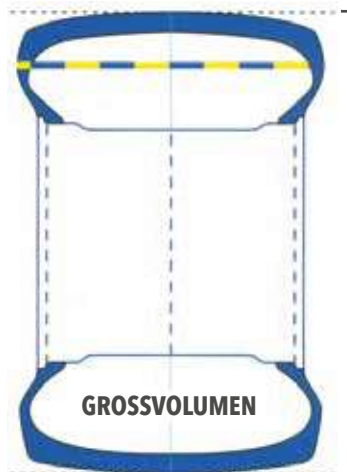

Umbereifung und Ballastierung

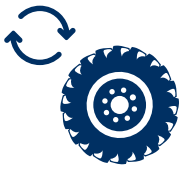

Umbereifung Umrüstattabelle AS-Bereifung

Höhe in mm	Standardreifen		Serie 70	Breitreifen Serie 65	Sonderbreiten auf Messfelge
	Zoll	Metrisch			
1605-1710	18.4 R 34	460/85 R 34	520/70 R 34	600/65 R 34	1000/50 R 25 620/75 R 30 600/65 R 34 700/55 R 34 800/50 R 34
1789-1825	23.1 R 34				650/75 R 32 620/75 R 34
1446-1496	12.4 R 36	320/85 R 36			480/70 R 30 540/65 R 30
1492-1581	13.6 R 36	340/85 R 36			620/70 R 26 600/70 R 28 520/70 R 30
1530-1605	13.6 R 38	340/85 R 38			460/85 R 30 600/65 R 30 480/70 R 34 540/65 R 34
1590-1646	14.9 R 38	380/85 R 38			620/75 R 26 600/70 R 30 710/60 R 30
1550-1605	15.5 R 38	400/75 R 38			540/65 R 34
1638-1721	16.9 R 38	420/85 R 38	480/70 R 38	540/65 R 38	620/75 R 30 650/70 R 30 600/70 R 34 650/60 R 34 650/65 R 34 600/60 R 38
1696-1825	18.4 R 38	460/85 R 38	520/70 R 38	600/65 R 38	650/75 R 32 (24.5 R 32) 710/60 R 34 600/65 R 38 650/60 R 38
1820-1906	20.8 R 38	520/85 R 38	580/70 R 38	650/65 R 38	800/65 R 32 1050/50 R 32 620/75 R 34 520/85 R 38 620/70 R 38 650/65 R 38 710/60 R 38

Technische Änderungen / Abweichungen / Ergänzungen vorbehalten

	Pfl gereifen		Kommunalreifen 65/70/80er Serie
	Zoll	Metrisch	
	12.4 //	300/95 R 42 320/90 R 42	480/80 R 34
	11.2 //	270/95 R 44	
	9.5 //	230/95 R 40	
	12.4 //	320/85 R 38	
	11.2 //	270/95 R 42	
	11.2 //	300/85 R 42	
	9.5 //	230/95 R 44	
	12.4 //	300/95 R 42 320/90 R 42	
	11.2 //	270/95 R 44	
	9.5 //	230/95 R 44	
	11.2 //	270/95 R 46	
	9.5 //	230/95 R 48	
	12.4 //	300/95 R 46	480/80 R 38
	12.4 //	320/90 R 46	600/65 R 38
	13.6 //	340/85 R 46	
	11.2 //	270/95 R 48	
		480/80 R 42	540/80 R 38
		460/85 R 42	650/65 R 38
		320/105 R 46	
	14.9 //	380/90 R 46	
		420/80 R 46	
	13.6 //	340/85 R 48	
	12.4 //	320/90 R 50	

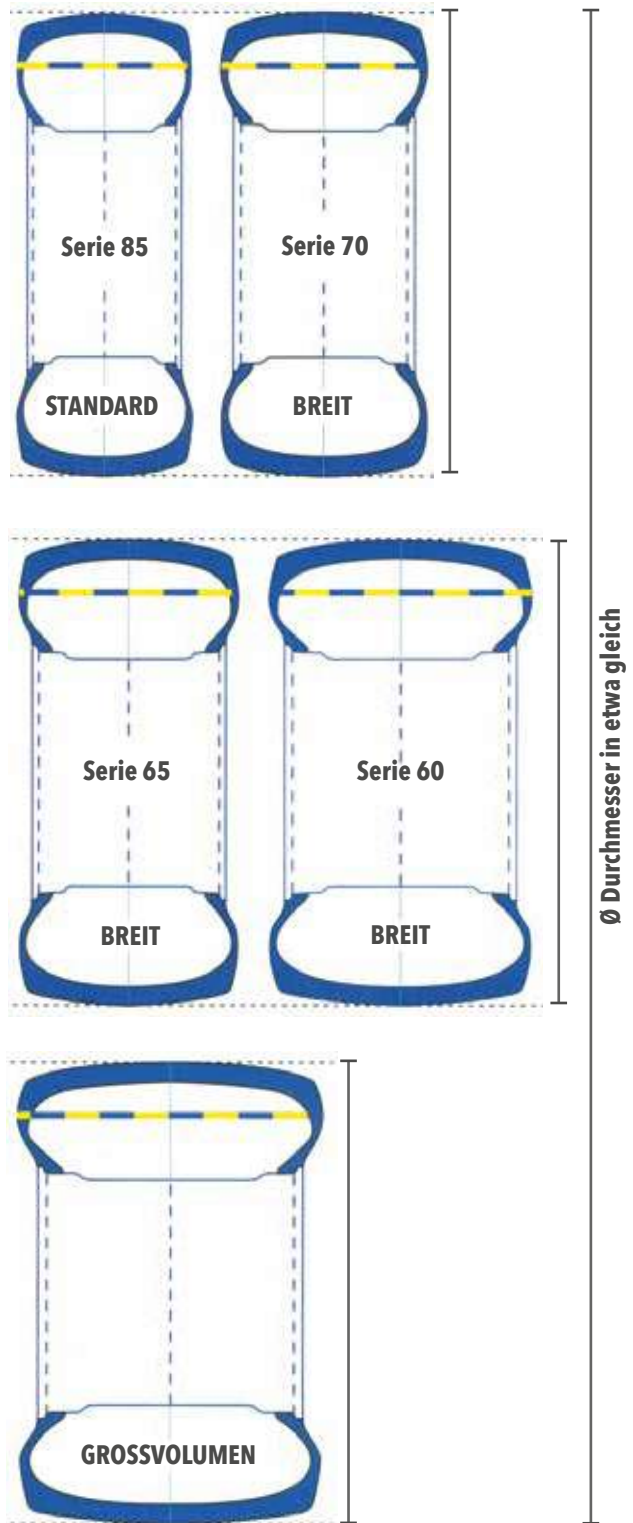

Umbereifung und Ballastierung

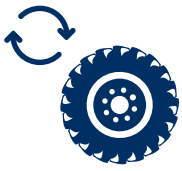

Umbereifung Umrüstattabelle AS-Bereifung

Höhe in mm	Standardreifen		Serie 70	Breitreifen Serie 65	Sonderbreiten auf Messfelge
	Zoll	Metrisch			
1820 bis 1865	18.4 R 42	460/85 R 42 480/80 R 42		600/65 R 42	680/75 R 32 710/75 R 32 800/65 R 32
1900 bis 1960	20.8 R 42	520/85 R 42	580/70 R 42 620/70 R 42	650/65 R 42	680/85 R 32 800/70 R 32 900/60 R 32 710/75 R 34 650/75 R 38 710/70 R 38 710/60 R 42 900/50 R 42
1933 bis 1970	18.4 R 46	460/85 R 46 480/80 R 46			680/85 R 32 800/70 R 32 650/70 R 38 680/75 R 38 620/70 R 42 900/50 R 42
2000 bis 2090	20.8 R 46	520/85 R 46	620/70 R 46		900/70 R 32 650/85 R 38 710/75 R 38 800/70 R 38 900/55 R 38 900/60 R 38 580/85 R 42 650/75 R 42 710/70 R 42 620/70 R 46 710/65 R 46
2140 bis 2195	20.8 R 50	520/85 R 50			710/85 R 38 650/85 R 42 680/80 R 42 710/75 R 42 800/70 R 42 900/60 R 42 750/70 R 44
2290 bis 2320					750/75 R 46 900/65 R 46

Technische Änderungen / Abweichungen / Ergänzungen vorbehalten

	Pfl gereifen		Kommunalreifen 65/70/80er Serie
	Zoll	Metrisch	
		320/105 R 46	540/80 R 38
	14.9 //	380/90 R 46	650/65 R 38
	16.9 //	420/80 R 46	
	12.4 //	320/90 R 50	
		480/80 R 46	
	14.9 //	380/90 R 50	
	12.4 //	300/95 R 52	
		230/115 R 54	
	11.2 //	270/95 R 54	650/65 R 42
		270/105 R 54	
	12.4 //	320/90 R 54	
	14.9 //	380/90 R 50	
	12.4 //	300/95 R 52	650/65 R 42
		230/115 R 54	
	11.2 //	270/95 R 54	
		270/105 R 54	
	12.4 //	320/90 R 54	
		380/105 R 50	650/85 R 38
		420/95 R 50	
	18.4 //	480/80 R 50	620/80 R 42
	14.9 //	380/90 R 54	710/70 R 42
		480/95 R 50	

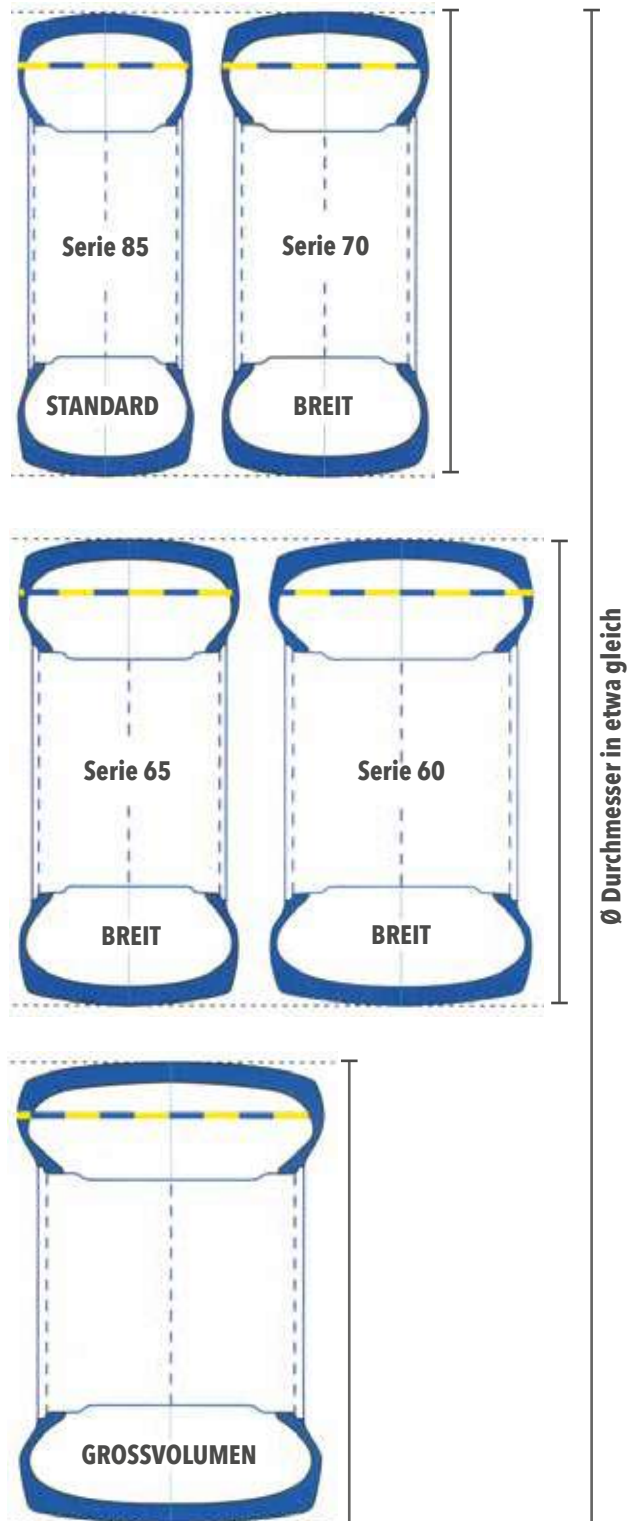

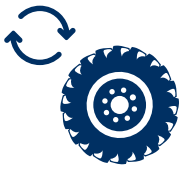

Umbereifung

Umrüstattabelle Kleinreifen

Reifendimension in Zoll	alte Zollgröße (Außendurchmesser x Breite)	metrische Größe (Außendurchmesser x Breite)
	8 x 2	200 x 50
8 1/2 x 2		220 x 50
2.50 - 3		210 x 65
	10 x 2	250 x 50
2.50 - 4		225 x (70) (65) (60)
9 x 3.50 - 4		230 x 90
3.00 - 4	10 x 3	260 x 85
4.10/3.50 - 4		265 x 100
11 x 7.00 - 4		270 x 185
4.00 - 4	12 x 4	300 x 100
12 1/2 x 2 1/4	2.25 x 8	310 x 50
3.50 - 6	13 x 3	340 x 100
4.00 - 6	14 x 4	350 x 100
13 x 6.50 - 6		320 x 150 oder 330 x 170
15 x 6.00 - 6		360 x 150
3.50 - 8	14 x 3	370 x 90 oder 390 x 96
4.80/4.00 - 8	16 x 4	400 x 100
4.00 - 8		420 x 120 oder 425 x 110
5.00 - 8	18 x 5	460 x 140
16 x 6.50 - 8		410 x (170) (140)
18 x 8.50 - 8		450 x (220) (210) (180)
18 x 9.50 - 8		450 x 220 oder 460 x 250 oder 460 x 230
20 x 8.00 - 8		500 x 210
21 x 12.00 - 8		540 x 280 oder 550 x 250
22 x 12.00 - 8		560 x 250
6.00 - 9	21 x 6	21 x 6

Technische Änderungen / Abweichungen / Ergänzungen vorbehalten



Umrüsttabelle Industrie- /Staplerreifen

Reifendimension in Zoll	metrische Größe
16 x 6 - 8	150/75 - 8
18 x 7 - 8	180/70 - 8
21 x 8 - 9	200/75 - 9
23 x 9 - 10	225/75 - 10
27 x 10 - 12	250/75 - 12
200 - 15	200/85 - 15
28 x 9 - 15	225/75 - 15
250 - 15	250/70 - 15
300 - 15	315/70 - 15

Technische Änderungen / Abweichungen / Ergänzungen vorbehalten



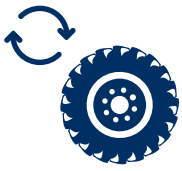

Umbereifung und Ballastierung

Ballastierung von Rädern

Verbesserung der Zugkraft

Im Einsatz von Landmaschinen sind stets gute Traktion und optimale Zugkraftübertragung gefordert, nur so kann eine Maschine im Leistungsoptimum gefahren und effizient eingesetzt werden.

Traktion wird durch drei Einflussgrößen gesteuert. Die Bodenbeschaffenheit, die Steigung und letztlich die Verzahnung der Reifen im Boden sind entscheidend für gute Traktion. Genauso wird so jedoch auch Rollwiderstand und Schlupf verursacht.

Je größer der Schlupf, desto stärker wird der Boden durch die Reifen schadverdichtet und desto schwieriger wird es, den vor den Reifen entstehenden Erdkeil beim Fahren zu überwinden (Bulldozingeffekt). Die Zugmaschine fährt bei erhöhtem Schlupf (im übertragenen Sinne) bergauf, was einen erhöhten Kraftstoffverbrauch und eine zerstörte Bodenstruktur zur Folge hat.

Optimale Schlupfwerte liegen zwischen 10 und 15%, Werte außerhalb dieses Bereiches gehen zu Lasten einer effizienten Fahrweise und schädigen die Bodenstruktur, was wiederum den Ertrag von Feldfrüchten mindert.

Warum ballastieren?

Eine zusätzliche Belastung des Zugfahrzeuges kann sich positiv auf die Zugkraftübertragung der Maschine auswirken. Gerade bei hohen Drehmomenteinsätzen, also bei der Bodenbearbeitung, der Stoppelbearbeitung und im Pflugeinsatz, wird so die Traktion der Reifen verbessert und unnötigem Schlupf vorgebeugt.

Eine optimale Ballastierung liegt bei folgender Gewichtsverteilung vor:

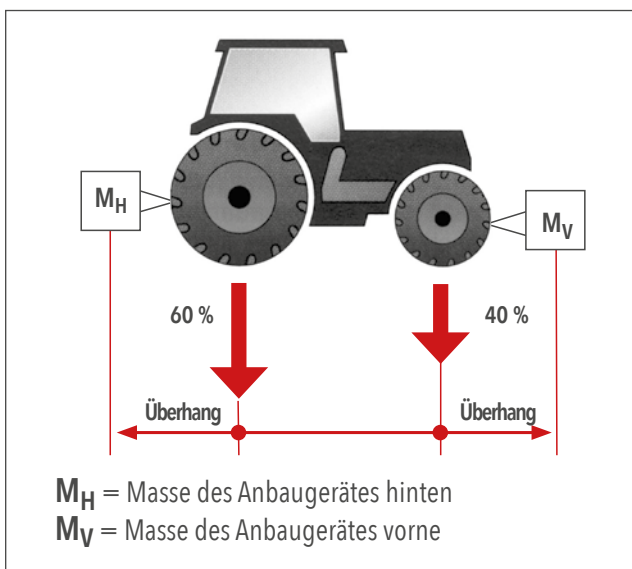

In Verbindung mit einem angepassten Luftdruck wird die Aufstandsfläche des Reifens vergrößert, so dass mehr Stollen sich im Boden verzahnen und damit die mechanische Zugkraft besser auf den Boden übertragen werden kann. Dies gewährleistet auch unterfeuchten Einsatzbedingungen eine gute Traktion.

Bei Transportarbeiten (Straßeneinsatz) erhöht eine Ballastierung den Leistungsbedarf und damit den Dieserverbrauch. Daher sind zusätzliche an- und abbaubare Radgewichte einer Wasserfüllung vorzuziehen. Sollte jedoch die Ballastierung für einen längeren Zeitraum vorgenommen werden oder eine Montage von zusätzlichen Radgewichten nicht möglich sein, stellt die Wasserfüllung der Reifen eine gute Alternative dar.



**Expertenwissen
kompakt**

Vor- und Nachteile Wasserfüllung:

- + verbesserte Zugkraftübertragung und damit höhere Traktion im Feldeinsatz
- geringere Elastizität des Reifens
- erhöhter Rollwiderstand, bei Straßenfahrt erhöhter Kraftstoffbedarf
- Belastung auf die Maschine und die Reifen / im Straßeneinsatz wirkende Kräfte nehmen zu

Wasserfüllung von Reifen

Sollte eine Ballastierung der Maschine für einen längeren Zeitraum vorgenommen werden oder eine Montage von zusätzlichen Radgewichten nicht möglich sein, stellt die Wasserfüllung der Reifen ebenfalls eine Möglichkeit der Ballastierung dar.

Bei einer Wasserfüllung sollten stets nur ca. 70 bis 75% des Reifenvolumens gefüllt werden, damit der Reifen nicht zu stark an Flexibilität verliert. Um diese Füllmenge zu erreichen, wird das Rad so weit gedreht, bis das Ventil in seiner höchsten Position steht (Näheres ist dem Unterkapitel Füllvorgang zu entnehmen). Die nachfolgende Tabelle gibt einen groben Überblick über Füllmengen verschiedener Reifendimensionen. Über spezielle Reifenvolumina und Füllmengen geben Ihnen unsere kompetenten Fachberater gerne Auskunft.

Füllmenge bei ca. 75 % Füllung Reifengröße		Füllmenge bei ca. 75 % Füllung Reifengröße		Füllmenge bei ca. 75 % Füllung Reifengröße	
Diagonal + Radial	Liter (kg)	Diagonal + Radial	Liter (kg)	Diagonal + Radial	Liter (kg)
10.0/80 - 12	35	405/70 R 24 MPT	155	320/90 R 32	150
7.5 L - 15	35	420/70 R 24	170	650/75 R 32	570
28x9.00 - 15	30	420/85 R 24	240	680/85 R 32	810
10.0/75 - 15.3	52	440/65 R 24	185	800/65 R 32	740
11.5/80 - 15.3	60	445/70 R 24 MPT	205	900/60 R 32	1030
6.00 - 16	30	16.9 - 24	215	16.9 - 34	265
6.50 - 16	35	480/65 R 24	210	380/85 R 34	240
7.50 - 16	40	480/70 R 24	225	420/85 R 34	290
200/70 R 16	35	480/75 R 24	240	460/85 R 34	380
240/70 R 16	40	495/70 R 24 MPT	260	480/70 R 34	310
260/70 R 16	45	500/85 R 24 IMP	310	480/75 R 34	335
265/70 R 16 MPT	45	540/65 R 24	300	520/70 R 34	355
285/80 R 16 MPT	60	14.9 - 26	180	540/65 R 34	360
15.0/55 - 17	77	16.9 - 26	222	18.4 - 34	350
19.0/45 - 17	95	18.4 - 26	305	600/65 R 34	465
425/55 R 17 MPT	95	23.1 - 26	450	9.5 - 36	95
505/50 R 17 MPT	145	28.1 - 26	590	270/80 R 36	115
10.5 - 18 MPT	60	8.3 - 28	55	12.4 - 36	160
12.5 - 18 MPT	95	280/85 R 28	100	13.6 - 36	180
14.5/80 - 18	115	11.2 - 28	90	13.6 - 38	190
280/70 - 18	55	12.4 - 28	125	340/85 R 38	215
325/70 R 18 MPT	82	320/85 R 28	130	16.9 - 38	290
355/60 R 18 MPT	102	13.6 - 28	145	420/85 R 38	320
365/70 R 18 MPT	105	340/85 R 28	160	460/85 R 38	420
10.5 - 20 MPT	65	14.9 - 28	190	480/70 R 38	340
12.5 - 20 MPT	105	380/70 R 28	165	15.5 - 38	245
14.5 - 20 MPT	135	380/85 R 28	205	18.4 - 38	390
16/70 - 20 EM	150	16.9 - 28	230	520/70 R 38	395
20 - 20	250	420/70 R 28	200	520/75 R 38	420
275/80 R 20 MPT	65	420/75 R 28	220	520/85 R 38	530
280/70 R 20	60	420/85 R 28	250	540/65 R 38	420
280/85 R 20	65	440/65 R 28	200	580/70 R 38	550
300/70 R 20	70	480/65 R 28	250	580/75 R 38	590
320/70 R 20	80	480/70 R 28	260	600/65 R 38	500
335/80 R 20	105	480/75 R 28	280	20.8 - 38	510
360/70 R 20	115	540/65 R 28	315	650/65 R 38	630
365/80 R 20 MPT	135	600/65 R 28	400	650/85 R 38	900
375/70 R 20 MPT	120	9.5 - 30	70	710/70 R 38	800
380/70 R 20	120	14.9 - 30	200	900/60 R 38	1200
405/70 R 20 MPT	140	380/85 R 30	220	9.5 - 42	110
425/75 R 20 MPT	150	16.9 - 30	240	11.2 R 42	135
445/65 R 22.5 MPT	170	420/70 R 30	225	20.8 R 42	560
9.5 - 24	65	420/85 R 30	270	300/95 R 42	185
11.2 - 24	75	460/85 R 30	340	460/85 R 42	460
12.4 - 24	110	480/70 R 30 MPT	275	520/85 R 42	580
280/85 R 24	85	495/70 R 30	300	650/65 R 42	650
320/70 R 24	100	540/65 R 30	330	380/85 R 46	330
320/85 R 24	115	18.4 - 30	310	460/85 R 46	500
13.6 - 24	120	600/65 R 30	440	520/85 R 46	620
340/85 R 24	140	600/70 R 30	490	270/95 R 48	150
360/70 R 24	125	710/60 R 30	600	13.6 R 48	230
380/70 R 24	145	8.3 - 32	60	340/85 R 48	230
380/75 R 24	155	9.5 - 32	80	380/90 R 50	360
380/85 R 24	185	270/80 R 32	100	480/80 R 50	550
14.9/80 - 24	150	12.4 - 32	140		
		300/85 R 32	140		

Die angegebenen Werte sind lediglich als Richtwerte zu verstehen.

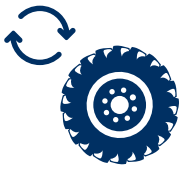

Umbereifung und Ballastierung

Flüssigkeitsempfehlung

Wird die zu ballastierende Maschine in Gebieten ohne Frostgefahr eingesetzt, so kann eine Füllung mit reinem Wasser vorgenommen werden. Da dies jedoch in den meisten Fällen nicht gegeben ist, muss dem Wasser ein Frostschutz hinzugefügt werden.

Mögliche Frostschutzzusätze sind Magnesiumchlorid $MgCl_2$ oder Kalziumchlorid $CaCl_2$. Diese werden in das Wasser gegeben (nicht umgekehrt), welches sich in einem verzinkten Behälter befindet. Das Gemisch wird zu einer einwandfreien Lösung verrührt. Positiver Nebeneffekt beim Zusatz von Frostschutzmitteln ist eine zusätzliche Gewichtszunahme.



Wichtiger Hinweis

Achtung!

Keinesfalls Wasser zum Magnesiumchlorid $MgCl_2$ bzw. Kalziumchlorid $CaCl_2$ geben!

Unbedingt das Magnesiumchlorid $MgCl_2$ bzw. das Kalziumchlorid $CaCl_2$ in das Wasser geben!

Für 100 Liter-Lösungen gelten bei den verschiedenen Temperaturstufen folgende Mischungsverhältnisse:

Frostschutz bei Temperaturen von	Für 100 l Füllung		Für 100 l Füllung	
	Magnesiumchlorid $MgCl_2$	Wasser	Kalziumchlorid $CaCl_2$	Wasser
-10 °C	24 kg	80 l	14 kg	95 l
-15 °C	33 kg	72 l		
-20 °C	40 kg	67 l	24 kg	90 l
-25 °C	45 kg	63 l		

Die Gewichtszunahme bei Verwendung von Magnesiumchlorid $MgCl_2$ bis -15 °C berechnet sich am Beispiel eines Reifens der Dimension 600/65 R 38 (Luftvolumen bei 75 % = 500 Liter) wie folgt:

Wassermenge:	500 Liter Luftvolumen	x	0,72 l Wasser	=	360 kg
$MgCl_2$ -Menge:	500 Liter Luftvolumen	x	0,33 kg $MgCl_2$	=	165 kg
Gesamtzusatzgewicht:	360 kg Wasser	+	165 kg $MgCl_2$	=	525 kg

* näherungsweise Berechnung



Wichtiger Hinweis

Bitte beachten!

Bei Wasserfüllungen ändert sich das Eigengewicht der Maschine, ggf. muss dies in den Fahrzeugpapieren nachgetragen werden (StVZO beachten).

Füllvorgang

Zunächst muss der Reifen vor einer Wasserfüllung mindestens auf den Normluftdruck gepumpt worden sein, damit ein richtiger Wulstsitz gewährleistet ist. Sofern die Wasserfüllung schlauchlos vorgenommen wird, muss ein kombiniertes Luft-/Wasserventil TR 618 A verbaut sein. Im Falle einer Schlauchbefüllung muss der Schlauch ebenfalls mit einem kombinierten Luft-/Wasserventil TR 218 A ausgestattet sein. Eine Wasserfüllung der Reifen mit Schlauch wird empfohlen, da somit eine Korrosion der Felge besser verhindert werden kann.

Das Fahrzeug muss sicher aufgebockt werden. Der Wagenheber wird so weit angehoben, bis dieser gerade festen Kontakt zur Achse hat und das Rad frei gedreht werden kann (während die Luft abgelassen wird, hält so der Wagenheber die Zugmaschine in ihrer Ursprungsposition). Das Rad wird so weit gedreht, bis das Ventil in seiner höchsten Position (für eine 75%ige Wasserfüllung) steht. Der Luftdruck sollte auf ca. 0,2 bis 0,5 bar abgesenkt werden, um im nächsten Schritt den Ventileinsatz durch ein kombiniertes Wasserfüll- und Entleerungsventil, die sog. „Hanauer Maus“, für die Befüllung ersetzen zu können.

Die zubereitete Frostschutzlösung kann über einen Schlauch durch das kombinierte Wasserfüllventil aus einem höher stehenden Behälter in den Reifen bzw. Schlauch einfließen. Bei einer Befüllung mit klarem Wasser (nur wenn keine Frostgefahr besteht) kann das Wasserfüllventil direkt an eine Wasserquelle angeschlossen werden.

Durch die seitliche Öffnung kann die Luft entweichen, solange die Flüssigkeit einfließt. Die vollständige Reifenfüllung von 70 bis 75% des Gesamtvolumens ist erreicht, wenn aus der Ventilöffnung Flüssigkeit austritt.

Nachdem die erforderliche Wassermenge in den Reifen eingefüllt wurde, wird der ursprünglich verwendete Ventileinsatz wieder eingeschraubt und der Reifen mit dem Normluftdruck aufgepumpt.



Wasserfüll- und Entleerarmatur „Hanauer Maus“

Ablassvorgang und Entsorgung

Um die Reifen bzw. den Schlauch zu entleeren, sind die gleichen Vorkehrungen wie bei der Befüllung zu treffen. Im Gegensatz zur Befüllung muss das Ventil auf den niedrigsten Punkt gedreht werden. Das Ventileinsatzstück wird entfernt, um das Wasser auslaufen zu lassen. Um das restliche Wasser im Reifen zu entfernen, wird das kombinierte Wasserfüll- und Entleerungsventil ohne den Schlauchstutzen aufgeschraubt und stattdessen der Ventileinsatz zur Luftbefüllung eingeschraubt. Wird in den Reifen Druckluft eingefüllt, so entweicht das restliche Wasser. Ist das gesamte Wasser entfernt, wird das kombinierte Wasserfüll- und Entleerungsventil entfernt und der normale Ventileinsatz in den Ventilschaft eingeschraubt. Der Reifen kann nun auf den gewünschten Luftdruck gepumpt werden.



Wichtiger Hinweis

Hinweis!

Sowohl Magnesiumchlorid-, als auch Kalziumchloridlösungen müssen, sofern nicht wieder verwertbar, gesondert entsorgt werden. Die Vorschriften unterscheiden sich nach Ländern

und Gemeinden, sodass die Lösungen unter Beachtung der Vorschriften der jeweils örtlichen Behörde entsorgt werden müssen.



Magnesiumchlorid Art.-Nr. 492.04.510

426

Übersicht unserer Felgentypen

428

Bezeichnungen und Abmessungen von Felgen

430

Einpresstiefen

431

Bolzenlöcher

432

Bolzenlochausführung

433

Bolzenlochbezeichnung nach EUWA ES 3.15

434

Räder- und Felgenmaße



GRUNDLAGEN FELGEN



SERVICE-PLUS BY BOHNENKAMP

Erhalten Sie direkten Zugriff
auf unseren Online-Shop



Bohnenkamp
■ ■ ● Moving Professionals



Übersicht unserer Felgentypen



Traktor-Anfertigungsfelgen (Standardfelge)

Traktorfelgen bestehen aus einem Felgenring und der eingeschweißten Felgenschüssel. Diese werden von uns je nach Anforderung mit dem passenden Lochkreis, der notwendigen Einpresstiefe und in der RAL-Farbe des Herstellers in allen erdenklichen Größen vom Pflege- bis zum Breitrad gefertigt.



Traktor-Anfertigungsfelgen mit Sondereinpresstiefen

Geht die Einpresstiefe über das normale Maß hinaus, so spricht man von Sondereinpresstiefe. Sie ermöglicht den Einsatz mit besonders hoher Spurbreite. Diese Sonderfelgen werden von namhaften Herstellern für Sie nach Wunsch gefertigt. Es ist dabei zu beachten, dass die extreme Bauweise zu einem geringen Verlust der Tragfähigkeit führen kann.



Spurverstellfelgen verstärkt

Spurverstellfelgen ermöglichen eine Verstellung der Spur ohne eine Demontage des Reifens, durch den Austausch der Felgenschüssel. Die Spurverstellung ist aber nur in einem begrenzten Rahmen möglich. Die verstärkte Ausführung ist für den Einsatz auf Traktoren bis ca. 180 PS geeignet.



Böckchenfelgen / Spurverstellfelgen

Diese veraltete Form der Spurverstellfelge ist vorwiegend für den Einsatz auf kleineren Traktoren geeignet. Sie kommt bei Fahrzeugen bis 100 PS zum Einsatz und überzeugt als preisgünstige Alternative.



Forstfelgen

Aufgrund der extremen Einsatzbedingungen sind diese Felgen mit einer vollverschweißten Radscheibe und einer zusätzlichen Felgenhornverstärkung ausgestattet. Der Ventilschutz bewahrt vor Abrisschäden des Ventils. Diese Felgen werden individuell nach Ihren Wünschen gefertigt und können je nach Fahrzeug und Anwendung in der passenden Spurbreite und Lackierung gewählt werden.



Pflegeradfelgen

Diese besonders schmalen Felgen kommen im Bereich der Pflegearbeiten, Düngung und Pflanzenschutz in wachsenden Beständen zum Einsatz. Es können verschiedene Felgentypen genutzt werden. Eine Ringverstellfelge (auch Flanschfelge genannt) sollte hierbei bauartbedingt nur für Traktoren bis 180 PS genutzt werden.

Im Katalog finden Sie unsere Felgen ab Seite 300



Standardkleinfelgen

Unsere Standardkleinfelgen sind 4-lappig verschweißt und aus hochwertigem Feinstahl gefertigt. Es sind alle gängigen Lochkreise, Einpresstiefen und Lackierungen lieferbar. In den Standardgrößen in der Regel direkt ab Lager.



Steilschulterfelgen

Eine 15° steile Schulter auf beiden Seiten des Tiefbetts dichtet den gerade montierten Reifen zur Felge hin ab. Hierdurch wird verhindert, dass bei sinkendem Druck der Reifen in das Tiefbett abrutscht. Steilschulterfelgen werden u. a. für die Ausrüstung von Flotation-Rädern eingesetzt. Sie bieten eine hohe Tragfähigkeit und werden durchweg in Erstausrüstungsqualität gefertigt.



Tiefbettfelgen

Die Standardtiefbettfelgen gehören zu unseren Serienfelgen. Die Vielfalt ist enorm: Diese Felgen sind in allen erdenklichen Ausführungen vom PKW-Trailerrad bis zum Schlepperrad in vielen Größen erhältlich und bei uns ab Lager lieferbar.



Felgen für Karren, Heu- und Gartenmaschinen

Wir bevorraten ein gewisses Spezialsortiment an Felgen für Karren, Heu- und Gartenmaschinen. Von zweiteiligen Schraubfelgen über mehrteilige Schwerlastfelgen bis hin zu Breitfelgen für Gartentraktoren.



Zwillingsfelgen

Zwillingsfelgen verbinden zwei Kompletträder miteinander. Diese Möglichkeit reduziert den Bodendruck und ermöglicht das Befahren von weichen Untergründen. Wir bieten zwei renommierte Systeme an. Das Radsystem von Trinker, geeignet für kleinere Traktoren bis 120 PS, sowie das Zwillingradsystem des englischen Herstellers STOCKS für schwere Einsätze.



Speziallösungen

Wir bieten ein umfangreiches Angebot an Spezial- und Sonderlösungen. Diese reichen von Forstfelgen, losen Innenringen über spezielle Felgen mit Topfkonstruktion, Kupplungssystemen bis hin zu individuellen Spurverbreiterungen.



Technische Informationen

Bezeichnungen und Abmessungen von Felgen

Nach der Definition der Felgenreissteller besteht das Rad aus der Felge und der Schüssel. Diese ergeben zusammen ein Rad. Das Felgenprofil ist genormt, damit der korrekte und sichere Sitz des Reifens gewährleistet ist.

In der Praxis wird normalerweise die Kombination aus Felgenreis und Schüssel als Felge und die Kombination aus Felge und Reifen als Rad bezeichnet. Dieses sind auch die Bezeichnungen, die für den folgenden Teil gelten.

Die Bezeichnungen von Felgenreis sind genormt. Hierfür gelten folgende Definitionen:

Maulweite der Felge

Die Maulweite (Felgenreisbreite) wird zwischen den Felgenreisrörnern gemessen.

Felgenreisdurchmesser

Der Felgenreisdurchmesser wird zwischen den Felgenreisrörnern ermittelt. Er entspricht dem Innendurchmesser des zu verwendenden Reifens und wird in Zoll angegeben.

Felgenreisausführung

Je nach der Form des Felgenreisrings wird zwischen Tiefbettfelge (W), Doppeltiefbettfelge (DW) oder Dreifachtiefbettfelge (TW) unterschieden.

Felgenreisrorn

Das Felgenreisrorn hält den Reifenswulst im aufgepumpten Zustand des Reifens fest. Je nach Höhe des Felgenreisrorns unterscheidet man verschiedene Codes (siehe Infobox).

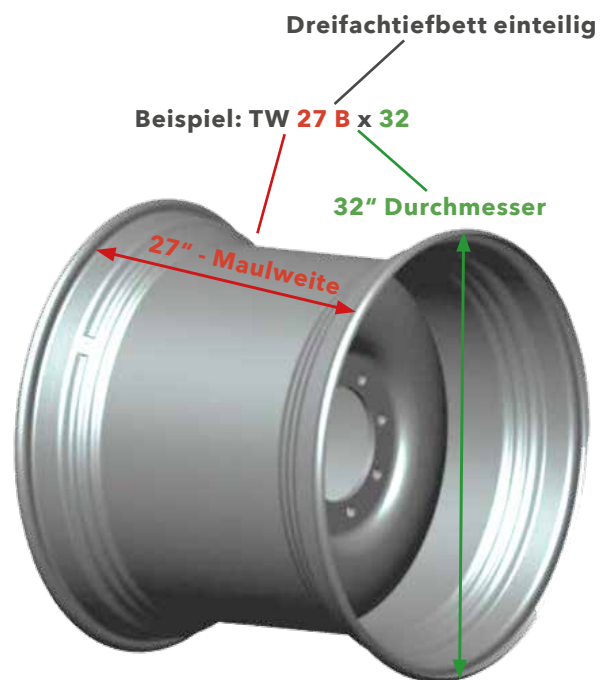

Achtung: klein, aber wichtig!

x = Bezeichnung einteilig	TW27 x 32"
- = Bezeichnung mehrteilig	14.00 - 25/1.5

Quelle: GKN



**Expertenwissen
kompakt**

Codes für die Felgenreisausführung:

W = Tiefbett
DW = Doppeltiefbett
TW = Dreifachtiefbett

Codes für die Felgenreisrornhöhe Beispiele:

D = 17,5 mm
E = 19,8 mm
F = 22,2 mm

Bedeutung der Felgenkennzeichnung am Beispiel der Traktorvorderradfelge W14L x 20

- W = Code für die Felgenform (einfaches Tiefbett)
- 14 = Maulweite in Zoll (zwischen den Felgenhörnern)
- L = Code für die Felgenhornausführung
- 20 = Felgendurchmesser in Zoll

W-Tiefbettfelge

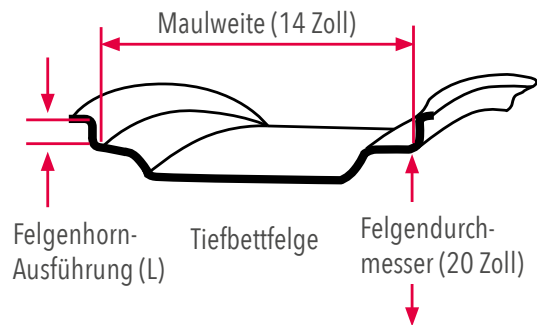

Bedeutung der Felgenkennzeichnung am Beispiel der Traktor-Hinterradfelge DW12L x 38

- DW = Code für die Felgenform (Doppeltiefbett)
- = Maulweite in Zoll (zwischen den Felgenhörnern)
- L = Code für die Felgenhornausführung
- 38 = Felgendurchmesser in Zoll

DW-Doppeltiefbettfelge

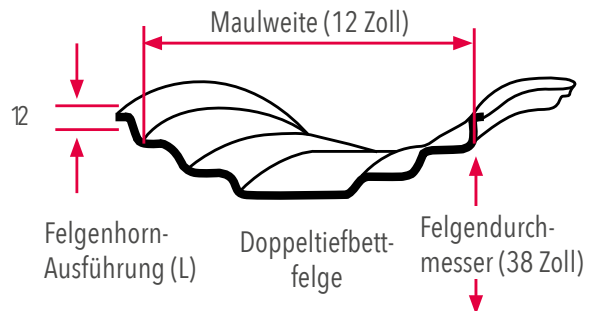

Bedeutung der Felgenkennzeichnung am Beispiel der Traktorhinterradfelge TW30 x 42

- TW = Code für die Felgenform (Dreifachtiefbett)
- 30 = Maulweite in Zoll (zwischen den Felgenhörnern)
- 42 = Felgendurchmesser in Zoll

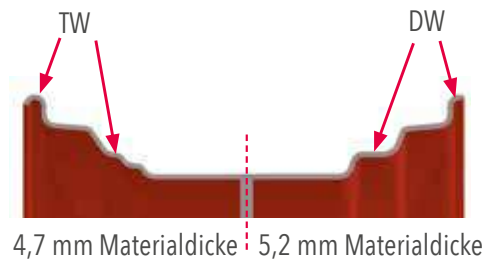

Vorteile der TW-Felgen

- + höhere Stabilität (trotz geringerer Materialdicke)
- + Langlebigkeit (reduzierte Spitzenbelastungen im Kröpfbereich)
- + erleichterte und schonende Reifenmontage
- + geringeres Gewicht gegenüber DW-Felgen



TW 18 x 42

- Felgenring-ausführung
- Breite Zoll
- einteilig
- Durchmesser Zoll

10 / 281 / 335 / B3 ET -50

- Anzahl Bolzenlöcher **10-Loch**
- Durchmesser Nabenloch **281 mm**
- Durchmesser Bolzenlochkreis **335 mm**
- Ausführung **Bolzenloch B = beidseitig gesenkt 3 = 27 mm Durchmesser**
- ET **Spur wird von der Achse aus gesehen pro Rad 50 mm breiter**

Quelle: GKN



Technische Informationen

Einpresstiefen

Die Einpresstiefe ist das Maß von der Felgenmitte bis zur inneren Anlagefläche der Felgenschüssel, wo das Rad an der Nabe befestigt wird.

Die Einpresstiefe kann als positiv (+) oder als negativ (-) bezeichnet werden.

Eine positive Einpresstiefe ergibt eine engere Spurweite. Eine negative Einpresstiefe ergibt eine breitere Spurweite. In den nachfolgenden Zeichnungen wird dies dargestellt:

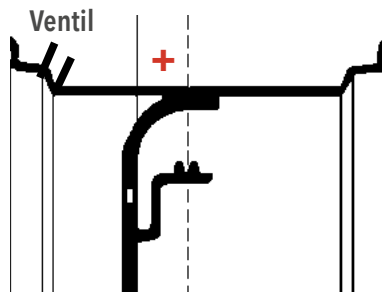

positive
Einpresstiefe = kleinere Spur

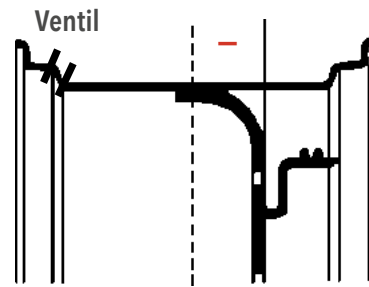

negative
Einpresstiefe = größere Spur

Errechnen der Einpresstiefe

$$\text{Einpresstiefe} = \frac{\text{Lattenmaß innen} - \text{Lattenmaß außen} + \text{Schüsselstärke}}{2}$$

L = Lattenmaß, d. h. die Distanz zwischen der Innenseite des Reifens und der Nabenseite der Radschüssel



**Expertenwissen
kompakt**

Hinweis

Bei einer positiven (+) Einpresstiefe wird die Spur kleiner.
Bei einer negativen (-) Einpresstiefe wird die Spur größer.
Bei einer Einpresstiefe von 0 mm sind das Spurmaß und die Achsweite (Flanschmaß) gleich.



Bolzenlöcher

Felgen mit Bolzenanschluss haben ein Nabenloch und mehrere Bolzenlöcher zur Befestigung an der Nabe. Bei der Befestigung der Räder an der Nabe ist es von größter Wichtigkeit, dass die Muttern festgezogen und nach kurzer Gebrauchszeit erneut nachgezogen werden. Bolzen und Muttern müssen regelmäßig kontrolliert werden, die Häufigkeit der Kontrollen ist abhängig von der Intensität des Gebrauchs. Angaben der Fahrzeughersteller beachten!

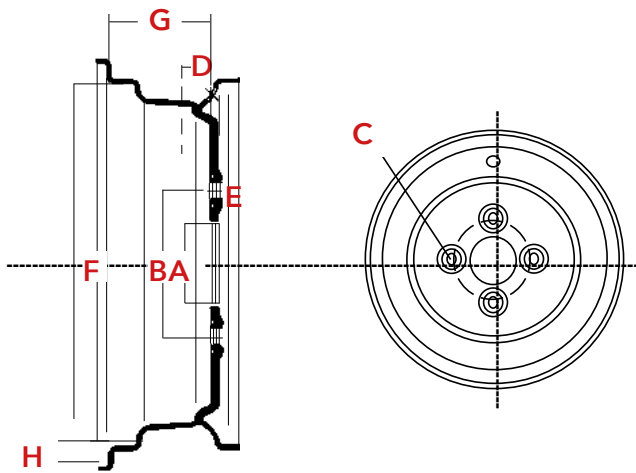

- A = Nabendurchmesser mm
- B = Bolzenlochkreis mm
- C = Bolzenlochzahl
- D = Einpresstiefe mm
- E = Bolzenlochdurchmesser mm
- F = Felgendurchmesser Zoll
- G = Felgenmaulweite Zoll
- H = Felgenhorn

<p>B3</p> <p>für 20/22er Bolzen</p>	<p>B2</p> <p>für 18er Bolzen IHC/Deutz/Schlüter</p>
<p>B5</p> <p>für 28,6 mm Bolzen Same/Ford</p>	<p>Ø 19er90°</p> <p>für 18er Bolzen MF/Fiat</p>
<p>Ø 20 Zyli.</p> <p>für 18er Bolzen John Deere</p>	

Die Ausführung der Bolzenlöcher ist für die Befestigung der Felge an der Nabe sehr wichtig. Achten Sie bei der Bestellung und der Montage neuer Felgen darauf, dass der Durchmesser, der Konus und das Kugelbett der Bolzenlöcher variieren können.

Die häufigsten Anschlussarten

Anzahl Bolzen	Nabenloch Ø	Bolzenlochkreis mm
4	60	100
5	67	112
5	94	140
5	110	160
6	110	150
6	161	205
8	221	275
8	290	330
8	362,5	405
10	281	335
12	371	425
12	760	814



Technische Informationen

Zentrierung und Bolzenloch

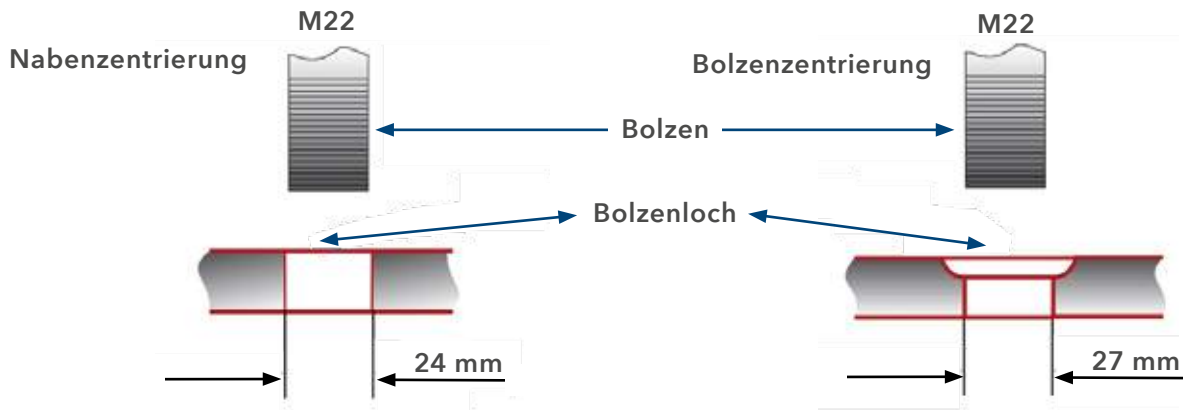

Bolzenlochausführung

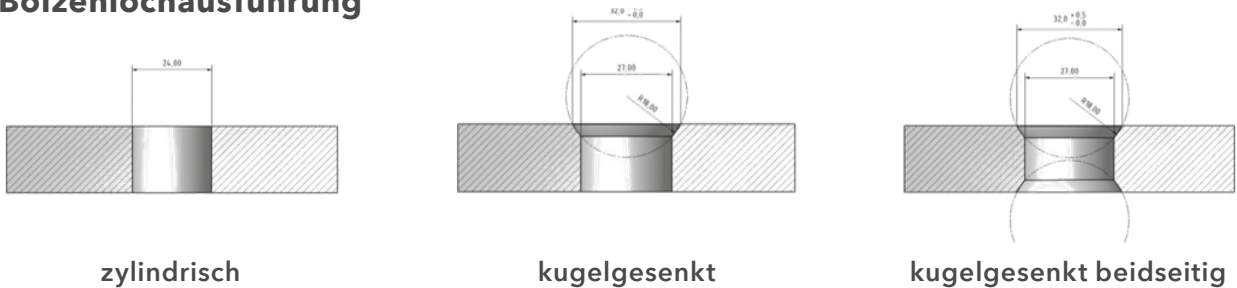

Bolzenlochbeschriftung

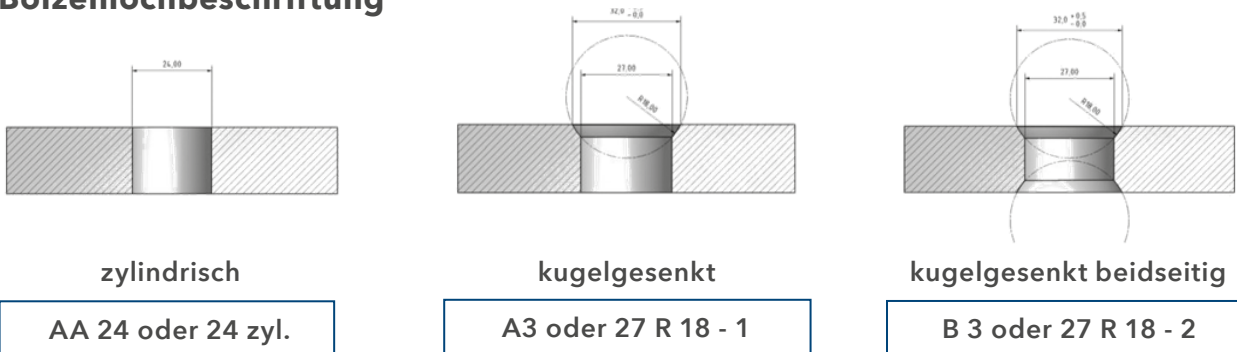

Beispiel für das richtige Befestigen eines Rades

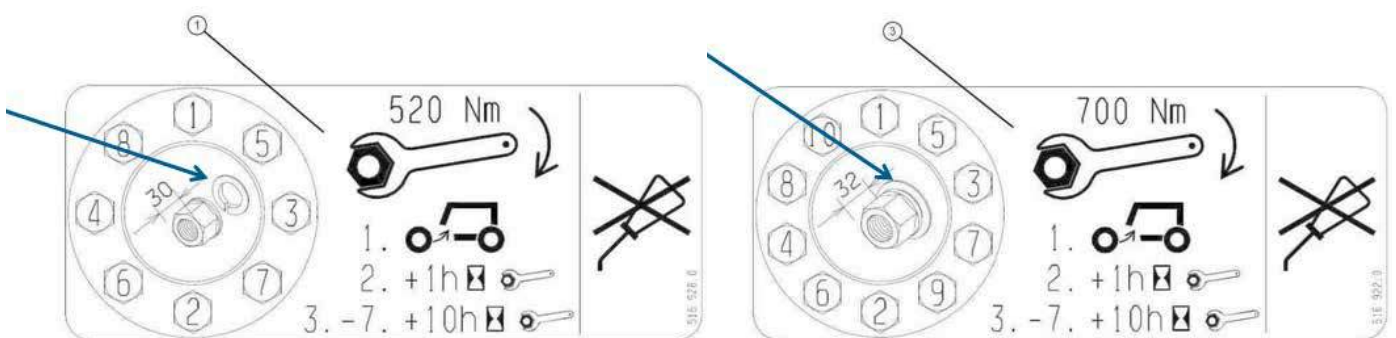

Quelle: GKN

Bolzenlochbezeichnung nach EUWA ES 3.15

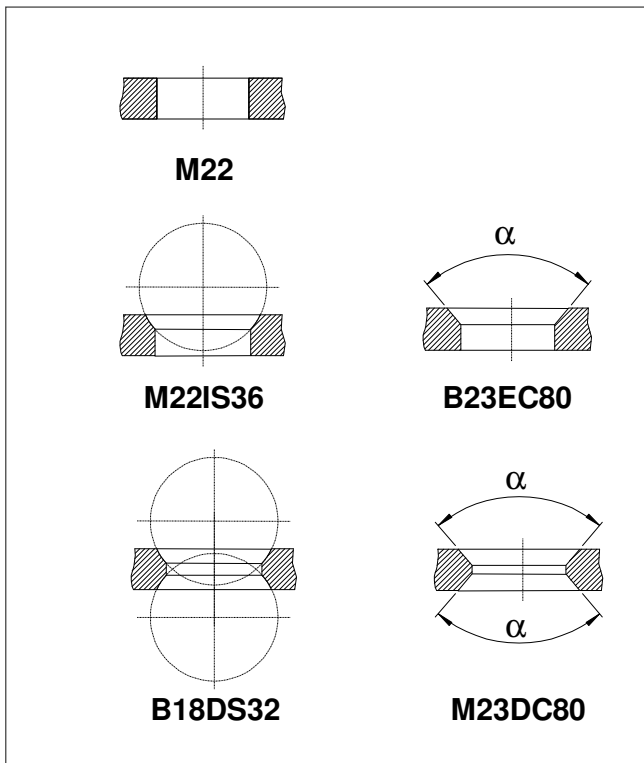
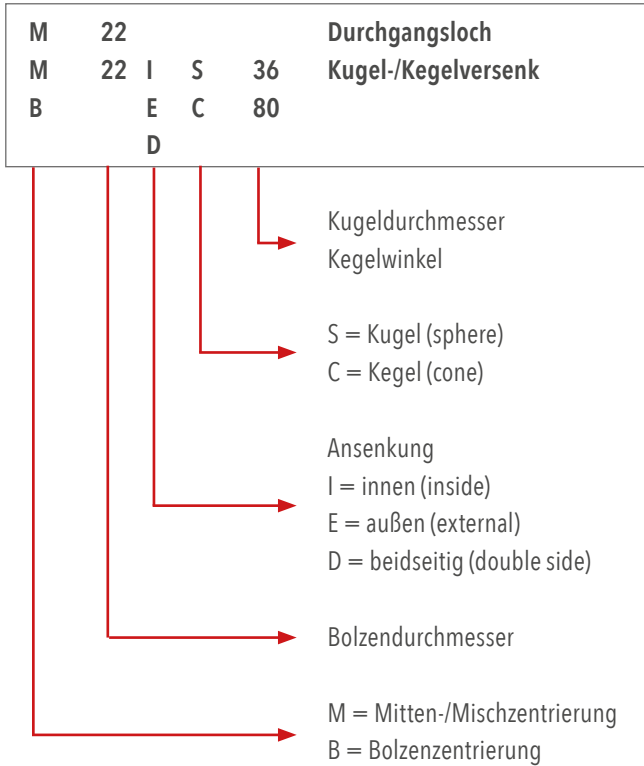

EUWA= Association of European Wheel Manufacturers

Für Räder mit Bolzenzentrierung (Kugelsenkung)

nach EUWA	Alter Standard	d1	d2	Kugel-Ø	Gewinde
B14 DS 28	B1	18,5	24	28	M14 x 1,5
B14 ES 28	A1	18,5	24	28	M14 x 1,5
B18 DS 32	B2	21,5	27	32	M18 x 1,5
B18 ES 32	A2	21,5	27	32	M18 x 1,5
B22 DS 36	B3	27	32	36	M22 x 1,5 (M20 x 1,5)
B22 ES 36	A3	27	32	36	M22 x 1,5 (M20 x 1,5)
B19 DS 44,4	B5	32,5	37,5	44,4	3/4"
B19 ES 44,4	A5	32,5	37,5	44,4	3/4"

Für Räder mit Doppelzentrierung (Kugelsenkung)

nach EUWA	Alter Standard	d1	d2	Kugel-Ø	Gewinde
M18 DS 32	B2	21,5	27	32	M18 x 1,5
M18 ES 32	A2	21,5	27	32	M18 x 1,5
M22 DS 36	B33	26	32	36	M22 x 1,5 (M20 x 1,5)
M22 ES 36	A33	26	32	36	M22 x 1,5 (M20 x 1,5)
M19 DS 44,4	B5	32,5	37,5	44,4	3/4"
M19 ES 44,4	A5	32,5	37,5	44,4	3/4"

Für Räder mit Bolzenzentrierung (Kegelsenkung)

nach EUWA	Alter Standard	d1	d2	Kugel-Ø	Gewinde
B23 DC 80	B17	25,4	31	80°	7/8"
B23 EC 80	A17	25,4	31	80°	7/8"

Für Räder mit Doppelzentrierung (Kegelsenkung)

nach EUWA	Alter Standard	d1	d2	Kugel-Ø	Gewinde
M23 DC 80	B37	26	31	80°	7/8"
M23 EC 80	A37	26	31	80°	7/8"

Für Räder mit Mittelzentrierung (zylindrische Bolzenlöcher)

nach EUWA	Alter Standard	d1	d2	Kugel-Ø	Gewinde
M18	Ø 21				M18 x 1,5
M20	Ø 24				M20 x 1,5
M22	Ø 26				M22 x 1,5



Technische Informationen

Räder- und Felgenmaße (Informationen für individuelle Räder)

Datum * _____

Kundenname * _____

Maschinentyp *	_____
Serien-Nr. *	_____
Modell *	_____ Jahr _____
Übersetzungsverhältnis 4WD *	_____

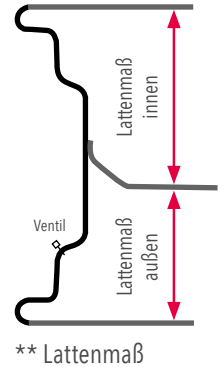
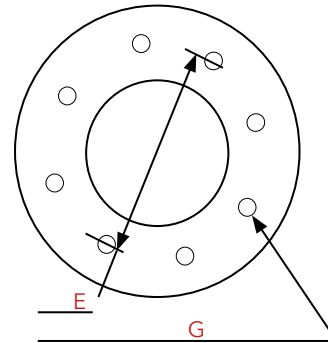

Dimension:	Vorderrad oder Felge	Hinterrad oder Felge
B. Innenspur	_____	_____
C. Spurmaß *	_____	_____
D. Gesamtbreite *	_____	_____
F. Achsweite (Flanschmaß) *	_____	_____
E. Lochkreisdurchmesser	_____	_____
G. Anzahl der Bolzenlöcher *	_____	_____
Reifengröße *	_____	_____
Reifenfabrikat u. Bezeichnung	_____	_____
Lattenmaß**	_____	_____

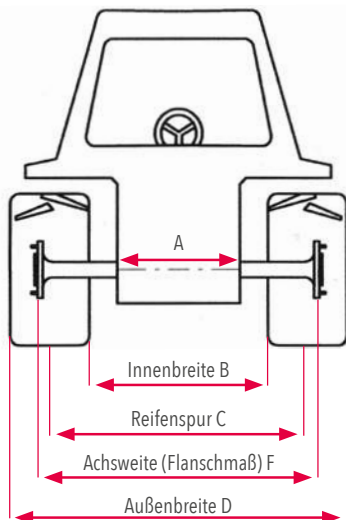

	Vorderachse	Hinterachse
*Zusatzlochkreis	ja <input type="checkbox"/> nein <input type="checkbox"/>	ja <input type="checkbox"/> nein <input type="checkbox"/>
Maße für Zusatzlochkreis	_____	_____
Anschluss für Reifendruckregelanlage	ja <input type="checkbox"/> nein <input type="checkbox"/>	ja <input type="checkbox"/> nein <input type="checkbox"/>
Felge verstärkt	ja <input type="checkbox"/>	ja <input type="checkbox"/>
Sonstiges	_____	_____

* Pflichtfelder

* Geplantes Lieferdatum: _____

Auswahl der passenden Felge

Grundsätzlich gilt: Montieren Sie einen Reifen immer auf eine vom Hersteller freigegebenen Felge! Die Montage auf einem falschen Felgendurchmesser oder einer falschen Ausführung kann zu ernsthaften Verletzungen während der Montage sowie zu einem Erlöschen der Betriebserlaubnis führen.

Angaben zur richtigen Felgenreöße finden Sie in den technischen Daten des Herstellers. Diese müssen vor jeder Montage unbedingt geprüft werden. (Abb. 1)

Reifen- größe	Profil- bezeichnung	Empfohlene und zugelassene Felgen	Breite in mm	Außen Ø in mm
540/65 R3 8	Agrimax RT 657	16, 18	530	1667
VF 540/65 R 38 NRO	Agrimax V-FLECTO	20, 18	549	1668
600/65 R 38	Agrimax RT 657	20, 18	611	1745
650/65 R 38	Agrimax RT 657	20, 18	645	1811
VF 650/65 R 38 NRO	Agrimax V-FLECTO	23, 20/21	650	1825
710/70R38	Agrimax RT 765	23	716	1959

Abbildung 1 Informationen zu freigegebenen Felgen
Die empfohlenen Felge ist in der Regel fett gedruckt.

Je nachdem, welche der freigegebenen Felgen Sie auswählen, kommt es zu Veränderungen im Fahrverhalten des Traktors. Durch die Montage auf einer breiteren oder schmaleren Felge lassen sich folgende Veränderungen erzielen:

Verwendung breiterer Felgen

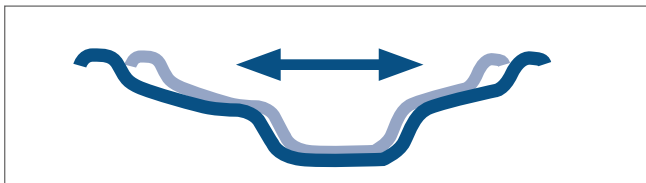

- Abflachung des Reifenprofils
- verbesserte Traktion auf lockeren Böden
- verminderte Traktion auf härteren Böden
- zusätzliche Belastung auf der Reifenschulter
- intensivere Abnutzung der Reifenschulter
- weniger flexible Seitenwand – die Karkasse bricht und/oder löst sich ab

Verwendung schmalere Felgen

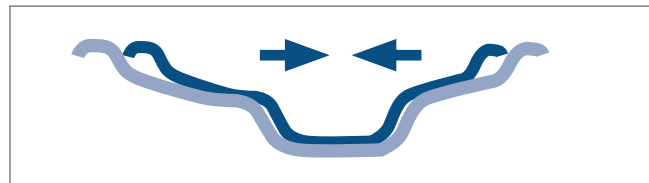

- Lauffläche des Reifens wird abgerundet
- weniger Traktion auf dem Feld
- mögliche Montageprobleme
- mögliche Ablösung der Seitenwand
- starke Abnutzung in der Mitte der Lauffläche

Bei einem Fehler in der Montage kann es zum sogenannten „Felgenschlupf“ kommen. Dieses bezeichnet das Drehen des Reifens auf der Felge.

Mögliche Ursachen hierfür können sein:

- zu niedriger Luftdruck
- inkorrekt sitzender Reifenwulst auf der Felge
- ungeeignete Montagepaste
- ungeeigneter Reifen für das hohe Drehmoment
- zu kleine Felge

Sollte es zu einem Drehen auf der Felge kommen, sollte zuerst der Luftdruck und die verwendete Felgenreöße mit dem Handbuch des Reifenherstellers verglichen werden. Entsprechen beiden den Vorgaben, sollte der Reifen demontiert und neu aufgeblasen werden. Besteht das Problem dennoch weiter, kontaktieren Sie gerne unsere Experten oder ggf. auch den Hersteller des Schleppers.

A blue tractor is shown in a field of golden wheat. The tractor is positioned in the upper right corner, with its front wheel and part of the engine visible. The field is filled with tall, golden wheat stalks. The tractor is moving through the field, leaving a trail of harvested wheat behind it. The background is a clear blue sky.

438

Traktor Anfertigungsfelgen

439

Felgen mit hohen Einpresstiefen

440

Felgen mit Topfkonstruktion

441

Spurverbreiterung

443

Forstfelgen - individuell

444

Zwillingsfelgen Systeme

450

Zwillingskupplungen

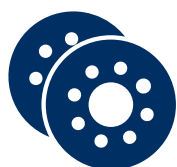

**TRAKTORFELGEN, ZWILLINGS-
FELGEN U. SONDERLÖSUNGEN**



SERVICE-PLUS BY BOHNENKAMP

Erhalten Sie direkten Zugriff
auf unseren Online-Shop



Bohnenkamp
■ ■ ● Moving Professionals



Traktorfelgen und Sonderlösungen

Traktor-Anfertigungsfelge (Standardfelge)

Traktorfelgen bestehen aus einem Felgenring und der eingeschweißten Felgenschüssel. Sie werden von uns, je nach Anforderung, mit dem passenden Lochkreis, der notwendigen Einpresstiefe und in der RAL-Farbe des Herstellers in allen erdenklichen Größen vom Pflege bis zum Breitrad geliefert.

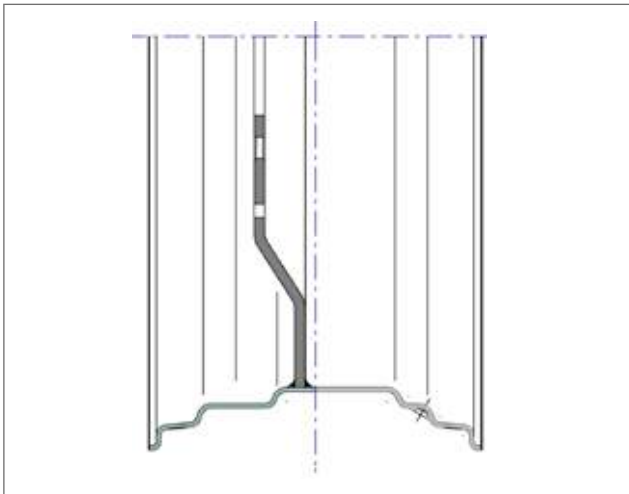

Radschüssel beidseitig verschweißt

- stabile Ausführung durch beidseitige Verschweißung
- umlaufende vollverschweißte Naht
- Ausführung in der Regel ab 24"-Felgen
- mehrere Planflächendurchmesser herstellbar
- verschiedenste Radschüsseltiefen und Dicken machbar
- durch beidseitige Verschweißung perfekte Lackierung möglich

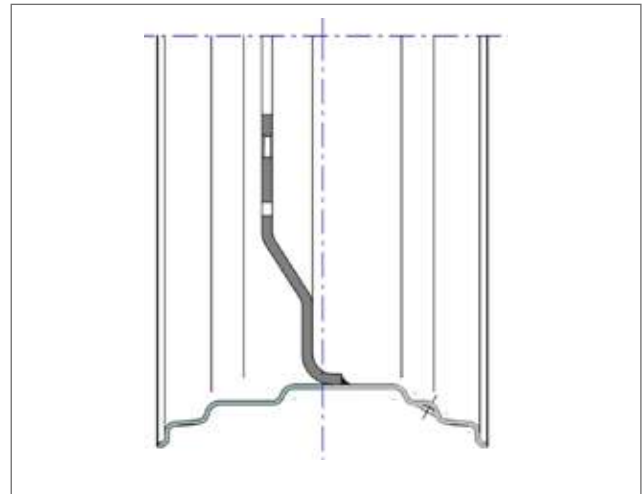

Radschüssel einseitig verschweißt

- Verwendung bei Kleinfelgen bis 20"
- für 24"-Felgen mit großem Radanschluss 290/330/8
- eingeschränkte Einpresstiefen
- wenn Zusatzlochkreis $\varnothing 430/6$ benötigt wird

Radschüsseln:

aus eigener Fertigung

- Material aus Feinkornstahl
- Radschüsseldicke 8-12 mm für Kleinfelgen bis 20"
- Radschüsseldicke 10-18 mm für Großfelgen ab 24" bis 54"
- Radschüsseldicke 20-25 mm möglich, daher eingeschränkte Radschüsseltiefen
- Radschüsseltiefe 50 mm bis 200 mm aus einem Stück
- Geschweißte Radschüsseltiefe bis 300 mm möglich mit Topfkonstruktion, hohe Radschüsseltiefen mit großer Planfläche möglich

Bearbeitung:

Mittenloch und Bohrungen an CNC-Bearbeitungszentren

- präzise Ausführung der Radanschlüsse
- verschiedenste Radanschlüsse möglich
- falls notwendig Planen der Planfläche

Zusatzleistung:

Optionen

- Zusatzlochkreis für Radgewicht
- Zusatzlochkreis für Zwillingskupplung
- Bohrungen für Zwillingsfelgenanschluss
- Ventilschutz offen und geschraubt
- Boxfelgen
- verstärkte Felgenhornausführungen
- 2. Ventiloch für Luftregelungsanlage (Zollrohr aufschweißen)

Lackierung:

- 2-Komponenten-Grundierung und 2-Komponenten-Decklackierung (= 2K-Lackierung)
- Pulverbeschichtung
- 2-farbige Lackierung möglich

Felgen mit hohen Einpresstiefen

Sind besondere Spurweiten erforderlich, welche sich nicht mit Standard-Fix- oder -Verstellfelgen realisieren lassen, bieten Felgen mit einer hohen Einpresstiefe eine Lösungsmöglichkeit.

Zu beachten ist jedoch, dass ab einer bestimmten Einpresstiefe höhere Toleranzen für Höhen- und Seitenschlag gelten.



Standardradschüssel 50/75/100 mm

Dicken 12,13,14,15,16 und 18 mm
Planflächen 350/400/500 mm
Ausführung je nach Machbarkeit



Sonderradschüssel 150 mm

Dicken 12,13,14,15 und 16 mm
Planflächen 400/500mm
Ausführung je nach Machbarkeit

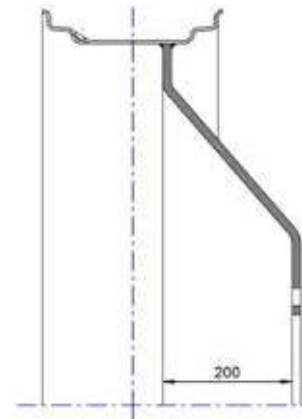

Sonderradschüssel 200 mm

Dicken 13,15 und 16 mm
Planflächen 400/500 mm
Ausführung nach Machbarkeit



Spezialradschüssel 250 mm

Dicken 15 und 19 mm
Planfläche 350 mm
Siehe technischer Hinweis



Fixfelge W10x48 ET-343 mm
mit Spezialradschüssel 300 mm
für JD, AW1664, Spur 2350 mm

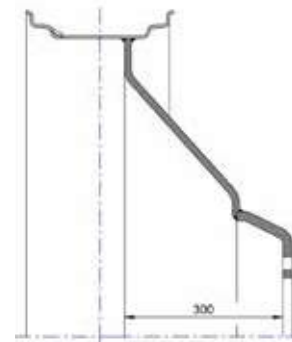

Spezialradschüssel 300 mm

Dicken 15 und 19 mm
Planfläche 350 mm
Siehe technischer Hinweis



**Expertenwissen
kompakt**

Technischer Hinweis

Für Felgen mit Sonderradschüssel 200 mm und Spezialradschüssel 250 mm und 300 mm gelten wesentlich höhere Toleranzwerte für Hoch- und Seitenschlag, eine eventuelle Laufunruhe kann daher nicht reklamiert werden. Ausgenommen sind auch Gewährleistungsansprüche für unregelmäßigen Reifenabrieb, Achs- oder Lagerschäden am Fahrzeug. Sämtliche hergestellten Felgen sind Sonderanfertigungen und daher ist keine Rückgabe möglich.



Traktorfelgen und Sonderlösungen

Felge mit Topfkonstruktion

Um eine extrem hohe Einpresstiefe mit großer Planfläche für Anschluss 330/8 , 335/10, 405/8 und 425/12 zu erreichen, ist eine geschweißte Topfkonstruktion notwendig. Auch hier gelten wesentlich höhere Toleranzwerte für Höhen- und Seitenschlag, eine eventuelle Laufunruhe kann daher nicht reklamiert werden. Ausgenommen sind auch Gewährleistungsansprüche für unregelmäßigen Reifenantrieb, Achs- oder Lagerschäden am Fahrzeug.

- Im Straßeneinsatz bis max. 30 km/h freigegeben
- Tragfähigkeit max. 60 % der Tragfähigkeit vom Reifen
- Für Ausnahmen ist unbedingt Rücksprache zu halten



Ringverstellfelge

- Durch das Umschrauben der Radschüssel erreicht man verschiedenste Einpresstiefen bzw. Spurweiten.
- 24"-Felgen in 6-Stern Ausführung (auch 8-Stern möglich)
28"-Felgen in 6- und 8-Stern-Ausführung ab 30 " in 8-Stern-Ausführung
- 12-Stern-Ausführung für schwere Traktoren
- Radschüsseldicken von 12 bis 15 mm
- verschiedenste Radschüsseltiefen bis 150 mm möglich
- verminderte Tragfähigkeit (Nachteil gegenüber Fixfelgen)
- nach Möglichkeit Fixfelgen bevorzugen
- auch 3-teilige Felgen verfügbar



Spurverbreiterung

Eine weitere Möglichkeit zur Erhöhung der Spurbreite sind Spurverbreiterungen. Diese werden zwischen den Lochkranz des Traktors und den Lochkranz der Felge geschraubt.

Spurverbreiterungen werden erst nach Rücksprache mit uns angeboten und gefertigt. Fertigung abhängig von Fahrzeugtyp, Radanschluss, Bauhöhe, usw.



Radanschluss	Inkl. Radbolzen	Durchmesser der Achsverbreiterung ca.
140/203,2/8	M18x1,5/M20x1,5	Ø 368 mm
150/203,2/8	M18x1,5	
153/203,2/8	M18x1,5/M20x1,5	
161/205/6	M18x1,5	
221/275/8	M18x1,5/M20x1,5	
290/330/8	M16x1,5	Ø 430 mm
281/335/10	M20x1,5/M22x1,5	
für Vorderachse		
281/335/10	M20x1,5/M22x1,5	Ø 430 mm
für Hinterachse mit 18 mm Scheiben		
371/425/12	M22x1,5	Ø 520 mm

Weitere Anschlüsse auf Anfrage

Bauhöhen: 80 - 100 mm
101 - 150 mm
151 - 225 mm

Ausführung:

in grundierter Ausführung (grau)

Aufpreis für Lackierung in Traktorfarbe

inkl. Radbolzen blank (ohne Radmuttern)

inkl. Lochausschnitt Ø ca. 45 mm im Lochkreis für die einfachere Befestigung der Radmuttern an der Radnabe, daher Nabenansatz außen zur Verstärkung der Achsverbreiterung von Vorteil

inkl. Nabenansatz außen - falls technisch herstellbar



**Wichtiger
Hinweis**

Technischer Hinweis

Keine Garantie für Höhen- und Seitenschlag.

Die Achsverbreiterung ist nur für den Arbeitseinsatz in Reihenkulturen mit niedriger Geschwindigkeit bis 10 km/h geeignet bzw. zulässig. Das heißt, diese Spurverbreiterung darf nicht für den normalen täglichen Einsatz verwendet werden (z. B. zur Verbreiterung der Spur für den Ketteneinsatz).

Bitte technischen Hinweis unbedingt dem Endverbraucher mitteilen!



**Verschiedenste Sonderlösungen
sind möglich!**
Schauen Sie auch im Shop unter:
[https://shop.bohnenkamp.de/service/
index/spezialumruistung](https://shop.bohnenkamp.de/service/index/spezialumruistung)

Individuelle Forstfelge

Forstfelgen sind für den Spezialeinsatz im Forst konzipiert. Aufgrund der extremen Einsatzbedingungen sind diese Felgen mit einer vollverschweißten Radscheibe und einer zusätzlichen Felgenhornverstärkung ausgestattet. Der zusätzliche Ventilschutz bewahrt das Ventil vor Abrisschäden. Je nach Fahrzeug und Anwendung kann eine individuelle Einpresstiefe und Lackierung gewählt werden.

Merkmale der Forstfelge gegenüber Traktorfelgen

- Ventilschutz offen (Halbmond)
- Ventilschutz voll mit schraubbarem Verschluss
- Boxfelgen / Felgenhorn verstärkt
- Forstverstärkte Felge mit Spickel



Ventilschutz offen
(Halbmond)



Ventilschutz voll mit
schraubbarem Verschluss



Boxfelge
Felgenhorn verstärkt



Forstverstärkte Felge mit
Spickel

LED-Druckwächter (472.00.995)



Set 1 beinhaltet
4 LED Druckwächter

Bohnenkamp Luftdruck Kontroll System (LKS) „LED-Druckwächter“
Der korrekte Luftdruck der Reifen ist extrem wichtig.
Das Bohnenkamp LKS ist optimal auf die OTR Einsätze geeignet.

- Die LED Leuchte blinkt ROT wenn der eingestellte Luftdruck unterschritten wird
- Wird die Batterie schwach (nach ca. 3 Jahren) blinkt sie GELB
- Einfache Montage und individuelle Kalibrierung
- Längere Lebensdauer der Reifen
- Echtzeit-Messung des Luftdrucks



Zwillingsfelgen System STOCKS

Zwillingsfelgen

Zwillingsradssysteme ermöglichen eine bessere Bodendruckverteilung auf weniger tragfähigen oder zu schonenden Böden. Die verschiedenen Systeme unterscheiden sich grundsätzlich in puncto Befestigungssystem und Größe des Fahrzeugs.

Jedoch fließen auch betriebliche Faktoren in die Entscheidung für ein Doppelradssystem mit ein.

Soll ein Radsatz angeschafft werden, welcher ausschließlich zur Doppelbereifung eingesetzt wird, bieten wir Ihnen zwei unterschiedliche Systeme. Für Traktoren und Radlader bis 120 PS das System Trinker. Für größere Traktoren oder Erntemaschinen empfehlen wir das System von dem englischen Hersteller Stocks. Bei dem von Stocks angebotenen System verfügt das Doppelrad über eine spezielle Felge ohne Felgenschüssel. Somit kann das Rad nur als Doppelrad eingesetzt werden.

Sollen Räder oder Felgen sowohl im Doppel- als auch im Einzelbetrieb am Fahrzeug genutzt werden, so kann dies mit der Zwillingskupplung von Trinker gelöst werden. Die Kupplungshälften dieses Systems werden an die Felgenschüsseln des Traktor- und des Doppelrades geschraubt und anschließend verzahnt. Das System kann sowohl für Pfliegeräder als auch für Standardräder genutzt werden. Unterschiedliche Einpresstiefen stellen ebenfalls kein Problem dar.



Der englische Hersteller STOCKS fertigt seit Jahren hochwertige Zwillingsradsysteme für den professionellen Einsatz auf Großtraktoren und Erntemaschinen.

Vorteile

- Montage durch eine Person
- in jeder Position problemlos anzubringen
- TÜV geprüft
- auch als Drillingsrad kombinierbar
- Grundiert ab Lager, gegen Aufpreis auch in jeder gewünschten Farbe lieferbar
- Erstklassige Qualität mit extrem starker Klemmschiene, die in einem speziellen Verfahren maschinengeschweißt wird
- Distanzringe bis zu 6 mm stark, inklusive Profilierung, um exakt in den konische Wulstsitz der Felge zu passen und ein Verkanten Hauptrad zu verhindern
- Alle Verschlusssteile bestehen aus geschmiedetem Stahl und sind garantiert unzerbrechlich

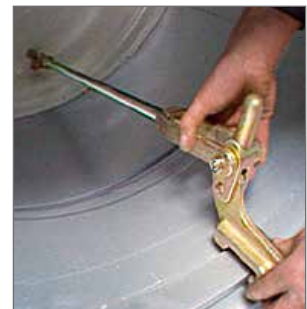

Das komplette Programm
finden Sie unter
www.bohnenkamp.de





Zwilling felgen System STOCKS

Spindel mit Haken

Artikel-Nr.	Artikelbeschreibung
-------------	---------------------

Spindeln

651.60.040	Spindel mit Haken 914 mm
651.60.050	Spindel mit Haken 1270 mm

Verschluss

651.60.110	Verschluss mit Distanzbügel
------------	-----------------------------

Schließrohr

651.60.150	Schließrohr
------------	-------------

Ösenmuttern

651.60.200	Ösenmutter "E" M16x1,5
651.60.260	Ösenmutter "H" M16x2,0
651.60.240	Ösenmutter "F" M18x1,5
651.60.270	Ösenmutter "N" M20x1,5
651.60.250	Ösenmutter "G" M20x2,5
651.60.210	Ösenmutter "L" M22x1,5

Ösenmuttern mit Keil und Bolzen

651.60.280	Ösenmutter M16x1,5
651.60.285	Ösenmutter M18x1,5

Ösenschraube

651.60.205	Ösenmutter "GB" M20x2,5 JD VA
651.60.220	Ösenmutter "T" M22x75 JD Gussnabe

Schrauben für Ösenmutter

651.60.242	Schraube für Öse "F" M18x1,5x40
651.60.243	Schraube für Öse "F" M18x1,5x50
651.60.245	Schraube für Öse "E" M16x1,5x35

Keilscheiben

651.60.650	Keilscheibe 10° Bohrung M18
651.60.654	Keilscheibe 15° Bohrung M18
651.60.651	Keilscheibe 20° Bohrung M18
651.60.652	Keilscheibe 30° Bohrung M18
651.60.653	V-Scheibe Bohrung M18

Ösenmutter	„E“	M 16x1,5	Für starre Felgen, bei denen ein Loch für die Ösenmutter gebohrt werden muss, oder bereits ein Loch mit Durchmesser 17-18 mm vorhanden ist. Auch bei SPV Felgen mit Verschraubung M16 einsetzbar.
Ösenmutter	„H“	M 16x2,0	Kann bei SPV Felgen JD 6er/7er/8er Serie auf den originalen Bolzen der Verschraubung aufgeschraubt werden.
Ösenmutter	„F“	M 18x1,5	Für starre Felgen, bei denen ein Loch für die Ösenmutter gebohrt werden muss, oder bereits ein Loch mit Durchmesser 19-20 mm vorhanden ist.
Ösenmutter	„N“	M 20x1,5	Wenn bereits ein Loch 21-22 mm in der Felge vorhanden ist
Ösenmutter	„GB“	M 20x2,5	Für John Deere 8er Serie Vorderachse im Austausch zu originalen Radbolzen, wenn kein Platz für andere Ösenmuttern vorhanden (auch bei 7er Serie möglich)
Ösenmutter	„T“	M 22x2,5	Nur für John Deere 7er und 8er Serie mit Gusschüssel im Austausch zu originalen Radbolzen
Ösenmutter	„L“	M 22x1,5	Kann direkt auf den Radbolzen geschraubt werden, wenn kein Platz für Ösenmuttern, z.B. bei Radladern
Ösenmutter mit Keil & Bolzen			Werden bei sehr stark gekröpften Felgen benötigt, z.B. OE Felgen Case Magnum HA
Kalottenmutter HD+M		M 18x1,5	Für starre Felgen, bei denen ein Loch für die Ösenmutter gebohrt werden muss, oder bereits ein Loch mit einem Durchmesser von 19-20 mm vorhanden ist.
Kalottenmutter HD+M		M 22x2,5	Nur für John Deere 7er und 8er Serie mit Gusschüssel im Austausch zu originalen Radbolzen

Spindel mit Kalottenkopf nur für HD+

Artikel-Nr.	Artikelbeschreibung
-------------	---------------------

Spindeln

651.60.415	Kalottenadapter mit Spindel 914 mm
------------	------------------------------------

Verschluss

651.60.110	Verschluss mit Distanzbügel
------------	-----------------------------

Schließrohr

651.60.150	Verschluss mit Distanzbügel
------------	-----------------------------

Kalottenmuttern inklusive Bolzen und Scheibe

651.60.636	Kalottenmutter HD+ M18x1,5
------------	----------------------------

Kalottenschraube

651.60.644	Kalottenmutter HD+ M22x2,5 für JD Gussnabe
------------	--

Schrauben für Ösenmutter

651.60.242	Schraube für Öse "F" M18x1,5x40
651.60.243	Schraube für Öse "F" M18x1,5x50
651.60.245	Schraube für Öse "E" M16x1,5x35

Keilscheiben

651.60.650	Keilscheibe 10° Bohrung M18
651.60.654	Keilscheibe 15° Bohrung M18
651.60.651	Keilscheibe 20° Bohrung M18
651.60.652	Keilscheibe 30° Bohrung M18
651.60.653	V-Scheibe Bohrung M18

Vorteil bei diesem System:

- leichtes Nachstellen der Spindellänge
- Einsatz bei Radgewichten

Zubehörteile System STOCKS**Ösenmutter**

- 651.60.200 | Öse E M 16 x 1,5
- 651.60.240 | Öse F M 18 x 1,5
- 651.60.250 | Öse G M 20 x 2,5
- 651.60.260 | Öse H M 16 x 2,0
- 651.60.270 | Öse N M 20 x 1,5

Ösenmuttern mit Keil und Bolzen

- 651.60.280 | Ösenmutter mit Keil und Bolzen M16 angewinkelt DZW
- 651.60.285 | Ösenmutter mit Keil und Bolzen M18 angewinkelt DZW

Ösenschraube (T / GB)

- 651.60.205 | Ösenmutter „GB“ JD 8R VA M20 x 2,5
- 651.60.220 | Ösenmutter „T“ JD 80 Anschluss M22 x 75

Spindel mit Haken

- 651.60.040 | 914 mm
- 651.60.050 | 1270 mm

Verschluss

- 651.60.110 | Verschluss mit Distanzbügel

Schließrohr

- 651.60.150 | Schließrohr

Schraube für Ösenmutter

- 651.60.242 | M18 x 1,5 x 40 Schraube „F“ galv. verz.
- 651.60.243 | M18 x 1,5 x 50 Schraube
- 651.60.245 | M16 x 1,5 x 35 Schraube „E“ galv. verz.

Kalottenmutter

- 651.60.636 | Kalottenmutter M18 - 1,5 HD Plus

Kalottenadapter mit Spindel

- 651.60.415 | Kalottenadapter mit Spindel 914 mm

Kalottenadapter ohne Spindel

- 651.60.410 | Kalottenadapter einteilig ohne Spindel

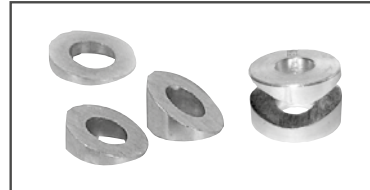
Keilscheiben

- 651.60.650 | Ausgleichsscheibe 10°
- 651.60.654 | Ausgleichsscheibe 15°
- 651.60.651 | Ausgleichsscheibe 20°
- 651.60.652 | Ausgleichsscheibe 30°
- 651.60.653 | Ausgleichsscheibe V



Zwillingsfelgen System TRINKER

Zwillingsradsystem

Der Clou an den praktisch entwickelten Zwillingsrädern des Herstellers TRINKER ist sicherlich der Schnellverschluss, der viele Vorteile bietet.

Sehen Sie selbst!

TRINKER-Zwillingsräder verringern den Bodendruck, steigern die Hangtauglichkeit, verbessern die Zugkraft und sparen Treibstoff durch weniger Schlupf.

TRINKER-Zwillingsräder gibt es auch für Transporter, Kleintraktoren, Ladewagen, Miststreuer, Traktorvorderräder usw.

- Sie sind im Handumdrehen anzukuppeln
- Erspart Schweißarbeiten am Traktorrad
Bügel- und Mitnehmerklauen sowie Verstrebungen im Radinneren sind überflüssig
- Verspannen der Zwillingsräder durch Anziehen des Hakenverschlusses mittels mitgelieferter Handkurbel
- Keine vorstehenden Teile am Traktorrad
- Abstand zwischen den Rädern wird durch einen Distanzring sichergestellt
- Montage durch 1 Person
- Decklack weiß



Bezeichnung	
5J	x 12
7J	x 12
9.00	x 12
10.50I	x 12
5J	x 15
7J	x 15
8LB	x 15
10LB	x 15
13LB	x 15
9.00	x 15.3
4.50E	x 16
5.50F	x 16
W8	x 16
W10	x 16

Bezeichnung	
11	x 16
13	x 17
5.50F	x 18
9	x 18
11	x 18
13	x 18
5.50F	x 20
W8	x 20
9	x 20
11	x 20
13	x 20
W7	x 24
W8	x 24

Bezeichnung	
W10	x 24
W12	x 24
W13	x 24
W15	x 24
DW12	x 26
DW14	x 26
DW16	x 26
W7	x 28
W8	x 28
W10	x 28
W12	x 28
W14	x 28
W15	x 28
W12	x 30

Bezeichnung	
DW15	x 30
DW16	x 30
W7	x 32
W8	x 32
W10	x 32
W15	x 34
W8	x 36
W10	x 36
W12	x 36
W10	x 38
W12	x 38
W15	x 38

Zwillingsfelgen mit unterschiedlichem Felgendurchmesser und anderen Verschlusszahlen sind auf Anfrage erhältlich.

CNC-gefräste Verzahnung

- daher perfekter Sitz in jeder Position
- direkte Übertragung der Kräfte in Fahrtrichtung
- geringe Abnutzung an der Verzahnung
- optisch sehr ansprechend

Kupplungshälften

- individuelle Breiten herstellbar
- Bereifungsabstand nach Wunsch
- hohe Rundlaufgenauigkeit
- kein Führungsring an der schlepperseitigen Kupplungshälfte notwendig
- Standardlackierung in 2K-Lack weiß
- Lackierung auf Wunsch in Felgenfarbe

Flansche

- Standard für Zusatzlochkreis Ø430/6-Loch und Ø430/12-Loch
- andere ZLK möglich, wie z. B. Ø500/6
- Befestigung am Radanschluss auch möglich, jedoch nicht empfehlenswert

Lösbare Brücke

- lösbare Brücke (auch Steg) in Sternausführung
- gefräste Verdrehsicherung gegen das Lösen der Kopfschraube
- galvanisch verzinkt
- optisch sehr ansprechend

Kopfspindel

- ausreichend dimensionierte Kopfschraube mit Ring - mit Anschlag für Verdrehsicherung
- inkl. Splint (Vorstecker)
- einfaches Schrauben mit Stange bzw. Verlängerung - galvanisch verzinkt
- optisch sehr ansprechend



Verschiedenste Sonderlösungen möglich - sprechen Sie uns gerne an!





TRINKER-Zwillingskupplung ZK

Kupplungshälften

Die Zwillingskupplungshälften werden am Zusatzlochkreis des Traktorrades und des Zwillingsrades montiert, wobei an den Kupplungshälften bei Verbund verzahnende Zahnkränze angeordnet bzw. im Eingriff sind.

Dadurch ist eine einfache Zwillingsradmontage in jeder Stellung mit einer Kopfschraube möglich. Sollte das Traktorrاد auch als Zwillingsrad gefahren werden, dann werden lediglich die lösbaren Brücken (Stege) getauscht, wobei die Kupplungshälften am Rad verschraubt bleiben können. Aufgrund der verschiedenen Bauhöhen der Kupplungshälften können gewünschte Abstände zwischen den Reifen erreicht werden.

Zwillingskupplung für starre Achsen

ZK 130	bis 130 PS	mit Kopfspindel
ZK 200	bis 200 PS	mit Kopfspindel
ZK 270	bis 270 PS	mit Kopfspindel
ZK 400	bis 400 PS	mit Kopfspindel

Zwillingskupplung für Vorderachse 371/425/12-Loch

ZK 130		mit Kopfspindel
--------	--	-----------------

Zwillingskupplung für Verschiebeachsen (Bar Axle)

ZK 200 VS	bis 200 PS	mit Hohlschraube
ZK 270 VS	bis 270 PS	mit Hohlschraube
ZK 400 VS	bis 400 PS	mit Hohlschraube



Zwillingskupplung für Verschiebeachse mit Hohlschraube



Zwillingslager für Standardreifen

Reifentypen-Codes

Schlepper Lenkreifen

F-1	Farm Einfachrippen-Profil
F-2-M	Farm Mehrfachrippen-Profil
F-2	Farm Mehrfachrippen-Profil
F-3	Industrie Mehrfachrippen-Profil

Schlepper Antriebsreifen

R-1	Antriebsrad, normales Profil
R-1W	Antriebsrad, für Traktion bei Nässe
R-2	Zuckerrohr und Reis, Antriebsrad, Tiefes Profil
R-3	Antriebsrad, flaches Profil
R-4	Industrie-Schlepper, Antriebsrad, Mittleres Profil
HF-1	Flaches Flotationprofil
HF-2	Normales Flotationprofil
HF-3	Tiefes Flotationsprofil
HF-4	Extra tiefes Flotationprofil

Implement-Reifen

I-1	Rippen-Profil
I-2	Moderate Traktion Implement
I-3	Traktionsprofil
I-6	Profillos
F-1	Rippen-Profil mit Straßenzulassung

TRA-Codes für EM-Reifen

Code	Profil	Maschine
C1	Profillos	C = Compactor Verdichterwalze
E1	Gerippt	E = Earthmoving Transportgeräte, Muldenkipper, Dumper, Mobilkran
E2	Traktion	
E3	Fels, normales Profil	
E4	Fels, tiefes Profil	
E7	Flotation	
G1	Gerippt	G = Grader
G2	Traktion	
G3	Fels, normales Profil	
G4	Fels, tiefes Profil	
G5	Fels, extra tiefes Profil	
L2	Traktion	L = Loader Radlader, Dozer, Planiergerät
L3	Fels, normales Profil	
L4	Fels, tiefes Profil	
L5	Fels, extra tiefes Profil	
L3S	Profillos	
L4S	Profillos, dicke Lauffläche	
L5S	Profillos, extra dicke Lauffläche	

Umrechnungstabelle

Längenmaße

1 Zoll	= 25,4 mm
1 Fuß	= 12 Zoll = 0,3048 m
1 Yard	= 3 Fuß = 0,9144 m
1 Meile	= 1,760 Yard = 1.609344 km
1 engl. Seemeile	= 1.8532 km
1 intern. Seemeile	= 1.852 km
1 Umdrehung	= 0,62 Umdrehungen pro km pro Meile

Flächenmaße

1 Quadrat-Zoll	= 6.415 cm ²
1 Quadrat-Fuß	= 929.0304 cm ²
1 Quadrat-Yard	= 0.83612736 m ²
1 ar	= 10 m x 10 m = 100m ²
1 acre	= 4.046.8654 m ²
1 Meile	= 0.40468564 Hektar
1 Hektar (ha)	= 2.4710538 acres
	= 100 m x 100 m = 10.000 m ²
1 Quadrat-Meile	= 2.5899881 km ²

Volumen

1 Kubik-Zoll	= 16.3871 cm ³
1 Kubik-Fuß	= 26.316847 dm ³
1 Kubik-Yard	= 0.76455486 m ³
1 Gallone (Imperial)	= 4.54609 L
1 Gallone (U.S.)	= 3.785412 L
1 Quart (Imperial)	= 1.136522 L
1 Quart (U.S.)	= 0.94635264 L

Geschwindigkeit

1 Meile pro Stunde	= 1.609344 km/h
1 Fuß pro Stunde	= 0.3048 m/s

Druck

1 PSI	= 6.894757 kPa
1 Standard Atmosphere	= 101.325 kPa
1 Bar	= 100 kPa = 14.5 PSI

Gewichte

1 Pound	= 0.4536 kg
1 metrische Tonne	= 1,000 kg = 2,205 pounds
1 englische Tonne	= 2240 pounds = 1.016 metr. Tonnen = 1016 kg
1 US Tonne	= 2000 pounds = 0,9072 metr. Tonnen = 907,2 kg

Temperatur

1° Fahrenheit	= (9/5 x Grad Celsius) + 32
1° Celsius	= (Grad Fahrenheit - 32) x 5/9

Kraft

1 PS (hydraulisch)	= 746.043 W = 0.746 KW
1 PS (Brems)	= 745.69999 W = 0.746 KW

Bohnenkamp AG Osnabrück Tel.: +49 541 12163-0

Niederlassung Landshut, Tel.: 08703-938-0

Niederlassung Kletzin, Tel.: 039998 - 316-0

Vertriebsbüro Leipzig, Tel.: 0341 - 39299-0

Vertriebsbüro Lüneburg, Tel.: 04131 - 29895-0

Vor Ort und international für Sie da.
Die Bohnenkamp Unternehmensgruppe



21.0056 Irrtümer vorbehalten



AGRAR

Bohnenkamp

■ ■ ● Moving Professionals

www.bohnenkamp.com